

# USER MANUAL

## Economical Low Speed Centrifuge (A6-50)

---



Before using centrifuge, please carefully read this user manual for efficient operation and safety.

Ver.20180830

# Contents

Safety Reminder .....	1
1. Intended use .....	3
2. Specifications .....	3
3. Declaration of Conformity .....	4
4. Required Operational Conditions .....	4
4.1 Basic operational conditions .....	4
4.2 Transport and storage conditions .....	4
5. Installation .....	5
5.1 Location .....	5
5.2 Connection of the power cord and grounding .....	5
6. Structure .....	6
8. Rotor Preparation .....	7
8.1 Prepare the samples .....	7
8.2 Inject the samples into tubes .....	7
8.3 Keep the tubes balanced .....	8
8.4 Inspect the rotor .....	8
8.5 Symmetrically load centrifuge tubes into rotor .....	8
9. Operation .....	8
9.1 Normal operation .....	8
9.2 RCF operation .....	10
9.3 Pulse operation .....	11
10. Maintenance .....	11
10.1 Cleaning .....	11
11. Troubleshooting .....	13
11.1 Possible problems and solutions .....	13
11.2 How to open the door .....	13
12. Instructions for the rotor and tubes .....	14
12.1 Rotor instructions .....	15
12.2 Tubes .....	15
13. Calculate RCF .....	17
14. Returning and Disposal .....	17
14.1 Returning Devices .....	17
14.2 Disposal .....	17
15. Ordering information .....	18
16. Warranty .....	18
16.1 Warranty of centrifuge .....	18
16.2 Warranty of the rotor .....	18
After-sales service .....	18

## Safety Reminder

### Common safety precautions

Carefully read the following safety precautions for a thorough understanding.

- Follow the instructions and procedures described in this manual to operate this centrifuge safely.
- Carefully read all safety messages in this manual and the safety instructions on the centrifuge.
- Safety messages are labeled as indicated below. They are in combination with signal words of “WARNING” and “CAUTION” with the safety alert symbol  to call your attention to items or operations that could be dangerous to you or other persons using this centrifuge. The definitions of signal words are as follows:



**WARNING:** Personal Danger

Warning notes indicate any condition or practice, which if not strictly observed, could result in personal injury or possible death.



**CAUTION:** Possible damage to centrifuge

Caution notes indicate any condition or practice, which if not strictly observed or remedied, could result in damage or destruction of the centrifuge.

**NOTE:** Notes indicate an area or subject of special merit, emphasizing either the product’s capability or common errors in operation or maintenance.

- Do not operate the centrifuge in any manner not described in this User Manual. When in doubt or have any troubles with this centrifuge, ASK FOR HELP.
- The precautions described in this User Manual are carefully developed in an attempt to cover all the possible risks. However, it is also important that you are alert for unexpected incidents. Be careful operating this centrifuge.



**WARNING**

- This centrifuge is not explosion-proof. Never use explosive or flammable samples.
- Do not install the centrifuge in or near places where inflammable gases are generated or chemicals are stored.

- Do not place dangerous materials within 30cm of the centrifuge.
- Prepare all necessary safety measures before using samples that are toxic, radioactive or contaminated with pathogenic micro-organisms. Use of these is at your own responsibility.
- If the centrifuge, rotor and accessories that have been contaminated by solutions with toxic, radioactive or pathogenic materials, clean it according to the decontamination procedure as specified.
- If you require service at site, please sterilize and decontaminate the centrifuge in advance, and then notify the service center the details of the materials and procedure.
- To avoid electrical shocks, insure hands are dry before handling the power cord or turning on/off the power switch.
- For safety purposes, do not enter within 30cm around this centrifuge when it is in operation.
- While the rotor is rotating, never release the door lock.
- Unauthorized repairs, disassembly, or modifying the centrifuge except by our service center are strictly prohibited.



## CAUTION

- This centrifuge must be located on a firm and level table.
- Make sure the centrifuge is horizontal before running.
- Do not move or relocate the centrifuge when it is running.
- If fluid spills in the rotor chamber, please promptly clean and dry with a dry cloth to avoid sample contamination.
- Ensure to remove any objects and fragments of the tubes dropped inside the rotor chamber before running the centrifuge.
- Cautions with rotor
  - (1) Always check for corrosion and damage on the rotor surface before using it. Do not use the rotor if an abnormality is found.
  - (2) Do not set the speed beyond the allowable minimum speed of the rotor kits (rotor and adapters). Make sure to run it below the allowable maximum speed.
  - (3) Do not exceed the allowable imbalance.
  - (4) Use the rotor and tubes within their actual capacities.If any abnormal condition occurs during operation, please stop it immediately and contact our service center. Notify the service center is a warning code if displayed.
- Vibrations are likely to damage the centrifuge, contact our service center if abnormality observed.

## 1. Intended use

This device is a medical product (laboratory centrifuge) within the context of the IVD Directive 98/79/EC. The centrifuge is used for the centrifugal separation of human blood or urine samples in the rotor in accordance with EN ISO 12772. Operator should be trained before using the centrifuge. Detailed operation, please refer to the **User Manual below**.

## 2. Specifications

Maximum speed	4000rpm(300-4500rpm), increment: 100rpm	
Maximum RCF	1800×g, increment: 100×g	
Maximum capacity	50ml×6, 15ml×6	
Timer	30seconds -99minutes-HOLD, continuous operation	
Deceleration curve	2 gear adjustable	
Noise	54dB(A)	
Driving Motor	Brushless DC motor	
Safety devices	Door interlock, Over-speed detector, Error code runtime display	
Power requirements	Single-phase, 100V-240V, 50Hz/60Hz, 3A.	
Ambient condition		
-Set-up site	Indoor only	
-Altitude	Up to 2000 m above sea level	
-Ambient temperature	2°C ~ 40°C	
-Humidity	80%	
-Excess-voltage category	II	
-Pollution degree	2	
Device protection class	I	
EMC		
-Emitted interference,	EN/IEC 61326-1	FCC Class A
Interference immunity	Class A	
Dimensions (mm)	(L) 354× (W) 301× (H) 217	
Weight	6kg	
Additional features	Speed/RCF switch, Pulse operation, LCD display of runtime status, buzzer notification & alert	

## 3. Declaration of Conformity

<b>Construction in accordance with the following safety standards:</b>
EN 61010-1
EN 61010-2-020
EN 61010-2-101
<b>Construction in accordance with the following EMC standards:</b>
EN 61326-1/ FCC Part 15 Subpart B/ IECS 001
EN 61326-2-6:2006
<b>Associated EU guidelines:</b>
EMC directive: 2004/108/EC
LVD directive: 2006/95/EC
IVD directive: 98/79/EC
This ISM device complies with Canadian ICES-001. Cet appareil ISM est conforme à la norme NMB-001 du Canada.

Changes or modifications not expressly approved by the party responsible for compliance could void the user's authority to operate the equipment.

NOTE: This equipment has been tested and found to comply with the limits for a Class A digital device, pursuant to Part 15 of the FCC Rules. These limits are designed to provide reasonable protection against harmful interference when the equipment is operated in a commercial environment. This equipment generates, uses, and can radiate radio frequency energy and, if not installed and used in accordance with the instruction manual, may cause harmful interference to radio communications. Operation of this equipment in a residential area is likely to cause harmful interference in which case the user will be required to correct the interference at his own expense.

## 4. Required Operational Conditions

### 4.1 Basic operational conditions

- (1) Power: 110V-240V, 50Hz/60Hz, 3A.
- (2) Ambient temperature: 2°C~40°C.
- (3) Relative humidity: ≤80%.
- (4) No vibration and airflow around.
- (5) No electric dust, explosive and corrosive gases around.

### 4.2 Transport and storage conditions

- (1) Storage temperature: -40°C~55°C.
- (2) Relative humidity: ≤93%.

## 5. Installation

This section describes the instructions that you should abide when install the centrifuge to ensure your safety and the optimum performance. Before moving the centrifuge, the rotor must be removed.

<p> <b>WARNING</b></p> <ul style="list-style-type: none"><li>● Improper power supply may damage centrifuge.</li><li>● Make sure the power source conforms to the required power supply before connecting.</li></ul>
------------------------------------------------------------------------------------------------------------------------------------------------------------------------------------------------------------------------------------------------------------------------------------------------------

### 5.1 Location

- (1) Place this centrifuge on a firm, flat and level surface, ensure the four feet of this centrifuge stand on the counter firmly. Avoid installing on a slippery surface or surface prone to vibration.
- (2) Ideal ambient temperature is  $20^{\circ}\text{C}\pm 5^{\circ}\text{C}$ , avoid placing the centrifuge in direct sunlight if temperature exceeds  $30^{\circ}\text{C}$ .
- (3) Keep clear of the centrifuge at least 10cm on both sides and at least 30cm behind it to guarantee the cooling efficiency.
- (4) Keep away from heat or water to avoid sample temperature issues or centrifuge failures.

### 5.2 Connection of the power cord and grounding

<p> <b>WARNING</b></p> <ul style="list-style-type: none"><li>● To avoid electrical shocks, ensure your hands are dry when touching the power cord.</li><li>● This centrifuge must be grounded properly.</li></ul>
------------------------------------------------------------------------------------------------------------------------------------------------------------------------------------------------------------------------------------------------------------------------------------------------------

An minimum 10A outlet providing a sufficient ground is required, and this must meet local safety requirements.

# 6. Structure

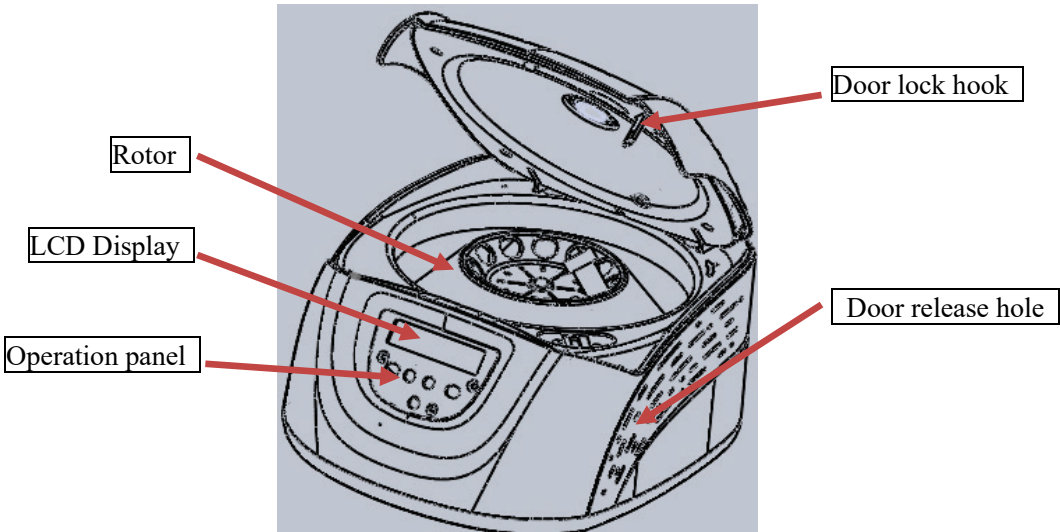

Figure 6-1 Front view of the centrifuge

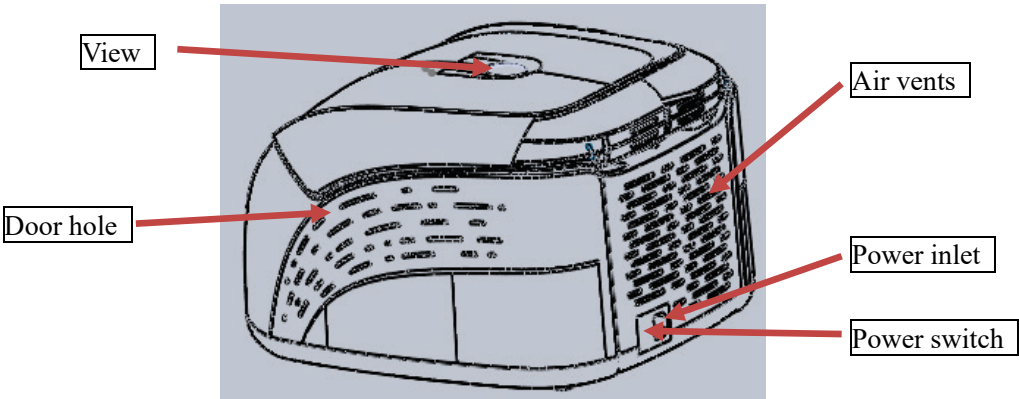

Figure 6-2 Rear view of the centrifuge

# 7. Operation panel

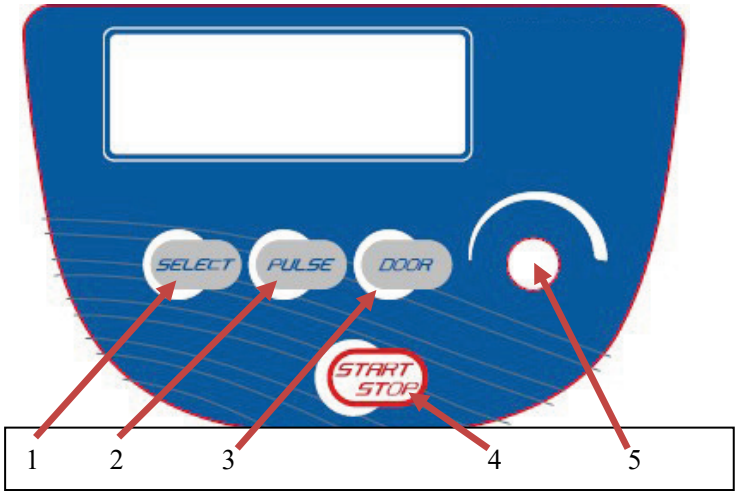







Figure 7-1 Operation panel



Item	Symbol	Name	Function
1		Select button	Press the button to choose the program which you want to modify.
2		Pulse button	The speed can be accelerated and held at the speed when pressing Pulse on.
3		Open/ lock button	Press the button to open the door The button is not available when the centrifuge is running.
4		Start/ Stop button	Press the button to start running. The centrifuge will brake to stop running if pressed during centrifugation.
5		Parameter button	Clockwise rotate to increase program values. Rotate anti-clockwise to decrease parameter values. Press the button, shift between speed and RCF display.

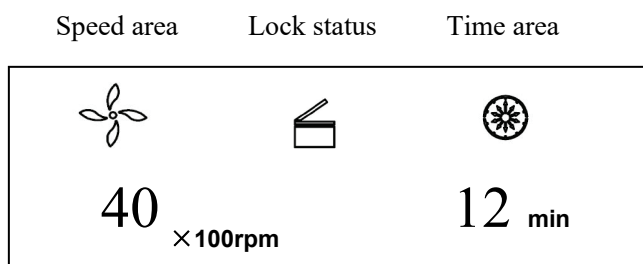



Figure 7-2 The main interface

Main interface is as figure 7-2. The speed is set to be 4500rpm, the door lock is released and the running time is 12 minutes. When speed symbol  is rotating, this indicates the centrifuge is running. If the rotation is faster, the speed is higher. Temperature of chamber is displayed and cannot be controlled. Time symbol  displays the ratio of working to time setting. The total time setting is divided into 10 sections.

## 8. Rotor Preparation

### 8.1 Prepare the samples

### 8.2 Inject the samples into tubes

 CAUTION

- Do not overload samples into the centrifuge which will cause leaking.

- Do not exceed the actual capacity allowed in the user manual.

### 8.3 Keep the tubes balanced

- Although the centrifuge can accept sample balancing by eye, we recommend that you keep this centrifuge in a well-balanced condition to extend its life expectancy.
- Never intentionally run the centrifuge under an unbalanced condition even though the allowable imbalance is not exceeded.

### 8.4 Inspect the rotor

Check the rotor for corrosion or scratches before using.

 CAUTION

- If any abnormality such as corrosion or scratches are found, stop using the rotor and contact our service center.
- Only manufacturer's rotors must be used with the unit.

### 8.5 Symmetrically load centrifuge tubes into rotor

 CAUTION

- Make sure the rotor lid is securely fixed on the rotor, as well as the rotor and shaft are tightened. Otherwise, the rotor may be moved off while rotating and cause damage to the centrifuge and rotor.
- Firmly tighten the rotor lid to the rotor.

## 9. Operation

 CAUTION

- Do not push or lean against the centrifuge while it is running.
- Do not run the centrifuge when fragments or sample solutions are left in the centrifuge chamber. Always keep the centrifugal chamber clean.
- If the centrifuge makes strange noise during operation, stop it immediately and contact our service center. Notify them of the warning code if displayed.

### 9.1 Normal operation

Turn on the power switch, centrifuge will display the running interface last time after passing the self-diagnostic checks, see figure 9-1 below:

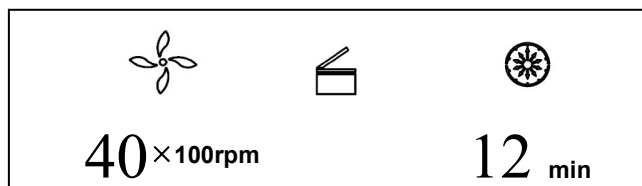











Figure 9-1 the last running interface

- Speed: 4000rpm. Running time: 12 minutes.
- The door lock is released.



### 1) Set the operation programs

Press the  button to select required program. The parameter can be modified when the program is flashing. Rotate the program button clockwise  to increase parameter value. Rotate the program button clockwise  to decrease parameter value. Rotate the program button  faster, and the parameter value will increase faster. The minimum speed increment is 100 rpm, the minimum time increment is 1 second.

#### (1) Set the speed

- Press the select button  until the speed rpm is displayed.
- When the speed button is selected, the speed symbol will flash the speed value.
- The minimum speed value you can set 500rpm, the minimum increment is 100 rpm.
- Rotate program button clockwise  to increase speed value. Rotate the program button anti-clockwise  to decrease speed value.
- You can speed-up set the speed value by rotating program button  quickly.
- There is a circulating function to increase/decrease the speed values. Rotate the program button clockwise  to change settings from small → large → maximum → minimum. Rotate the program button anti-clockwise  to change settings from large → small → minimum → maximum.

#### (2) Set the time



- Press select button , time value flashes in the time setting mode.
- Rotate the program button  to set running time from 30 seconds to 99 minutes.
- When the time displays HD, this is a continuous running mode.

### 2) Start the operation

#### (1) Press button to start running

- The door must be locked before rotor starts spinning.
- The timer will start once the rotor starts spinning, the screen displays the remaining run time.

## (2) View and modify the operation programs

- Operation programs can be modified after the centrifuge reaches the set speed.
- Pressing the select button , returns the display to the program interface and displays setting programs. Press the select button  to the desired program. When flashing, rotate parameter button  to modify values. Release the button after 5 seconds, and the centrifuge will return to normal operation mode and run according to the new value.
- If the set time value has been modified, the operation time is not affected and will continue.

## (3) Warning display

- If an error occurs during the operation, the centrifuge will brake to stop automatically, and display the error code on the time/display area. The error code can be checked in the table 11-1, and corrective actions can be applied accordingly.

**3) End the operation**

(1) The centrifuge will brake when it reaches the set time or  button is pressed.

- When the rotor stops rotating, the centrifuge will start beeping to alert the operation has finished.

## (2) Open the door

- The door can be released automatically when the operation has stopped.
- With the door closed, you are able to press the  button to open it.
- After ending the operation, the program will store the setting parameters of this operation, and will recall these parameters when restarting the program.

(3) Open the door and take out the rotor and samples.



**9.2 RCF operation**

(1) Turn on the power switch

(2) Set a RCF (Relative Centrifugal Force) value

**⚠ CAUTION**

- Do not exceed the allowable maximum RCF value of the rotor and adapters.

- Press the select button  and choose speed unit  $\times g$ , the speed symbol will flash into RCF value input status.
- If no button is pressed after the speed value has flashed after 5 seconds, the input mode will be shut down.
- Rotate program button  to input a RCF value, RCF increment is  $10\times g$ .

(3) Set operating conditions

The other operation, please refer to the section 8.1.



### 9.3 Pulse operation

This function is used to remove the residual samples adhered to the interior of the tubes or for quick spins.

**Note:** The button works only while the rotor stopped and the door is locked.

(1) Turn on the power switch and load the rotor to the shaft, tighten the rotor lid and make sure it is in secured position, and then close the door.

(2) The centrifuge goes into preparation mode and displays last running values.

(3) Press  knob and hold, the centrifuge will speed up to the setting speed. While releasing the  knob during acceleration, the centrifuge will start to decelerate and stop.

### 9.4 Curve operation of speed reduction

(1) Quick reduction of speed

The default state is in a quick stop mode. Please keep pressing the “” key for more than 7 seconds, when the LCD displays F, release the “” key, then gently press the “” key to enter the quick stop mode.

(2) Slow reduction of speed

Please keep pressing the “” key for more than 7 seconds, when the LCD displays L, release the “” key, then gently press the “” key to enter the slow stop mode.

## 10. Maintenance

### 10.1 Cleaning

 **CAUTION**

- If do not follow the recommended instructions for cleaning or disinfecting this may damage the centrifuge.

(1) Centrifuge

- If the centrifuge is exposed to ultraviolet rays for a long time, the color of the door may be changed or the label may be peel off. After using, cover the centrifuge with a piece of cloth to protect it from direct exposure.
- If the centrifuge needs cleaning, clean it with a cloth or sponge moistened with a neutral detergent solution.
- Sterilize the centrifuge by wiping with a cloth moistened with 70% ethanol solution.

---

(2) Rotor chamber

 CAUTION

- Do not directly pour water, neutral detergent or disinfectant solution into the rotor chamber, otherwise fluids may leak into the drive units and cause corrosion or deterioration to the bearings.
- 
- If the rotor needs cleaning, clean with cloth or sponge moistened with a neutral detergent solution. Sterilize the centrifuge by wiping with a cloth moistened with 70% ethanol solution.
- (3) Drive shaft
- We recommend regular maintenance for drive shaft. You can wipe the drive shaft with soft cloth, and then apply a thin coat of silicon grease.
- (4) Door
- Clean and sterilize the door using the same method as the section (1) above.
- (5) Rotor
- To prevent corrosion, remove the rotor from rotor chamber. If not in use for a long term, then detach the rotor lid and turn upside down to dry the tube holes and keep clean.
  - For sample leaks in the rotor, rinse the rotor with water. Apply a thin coat of silicon grease to the rotor when it is completely dry.
  - The rotor should be checked every 3 months to ensure the tube and rotor holes keep are clean and apply a thin coat of silicon grease.

# 11. Troubleshooting

## 11.1 Possible problems and solutions

This centrifuge has a self-diagnostic function. If a problem occurs, an error/warning code will be displayed on the time display screen, and the operator can determine the malfunction with the alarm code below.

Symptom	Causes	Solutions	
Nothing appears on the screen when the POWER is turned on.	<ul style="list-style-type: none"> <li>• Building power circuit breaker trips.</li> </ul>	<ul style="list-style-type: none"> <li>• Remove the trouble and turn on the POWER.</li> </ul>	
Abnormal vibration	<ul style="list-style-type: none"> <li>• Rotor do not match with spindle</li> <li>• Samples are imbalance</li> </ul>	<ul style="list-style-type: none"> <li>• Install again the rotor</li> <li>• Weighting scales, install symmetrically</li> </ul>	
Alarm code appeared on the time display screen	E-02 Door fault	<ul style="list-style-type: none"> <li>• The door opened in running.</li> <li>• The  button is pressed while the door opening.</li> </ul>	<ul style="list-style-type: none"> <li>• Close the door immediately.</li> <li>• Close the door, and then start to operate.</li> </ul>
	E-06 Set wrong speed	<ul style="list-style-type: none"> <li>• The setting speed exceed the allowable range.</li> </ul>	<ul style="list-style-type: none"> <li>• Modify the speed value.</li> </ul>
	E-10~86	<ul style="list-style-type: none"> <li>• Read the service manual</li> </ul>	<ul style="list-style-type: none"> <li>• Contact with service center</li> </ul>

Table 11-1 Possible problems and solutions

- Alarm codes E-1~E-9 are related to incorrect operation/programming. You can continue running the centrifuge after implementing corrective procedures.

## 11.2 How to open the door

### 1) In the case of power on

#### CAUTION

- The door just can be opened while the power is on and rotor stops rotating.

- (1) Turn on the power switch, release the door automatically.
- (2) The door will be released automatically once the operation is finished.
- (3) It is available to release the door by press  button once the rotor stops.

### 2) In the case of power outage

The door cannot be opened automatically if there is a power outage. It is available to be opened manually as follows.

- (1) Ensure if the rotor has stopped rotating.
  - Listen carefully to ensure no rotating sound can be heard.
- (2) Insert a screw driver into a hole to open door.
  - Holes are located on the left and right sides of the unit.
  - Insert a screw driver into the two holes and push forward to release the door.

## 12. Instructions for the rotor and tubes

 CAUTION

- Read the instructions thoroughly, to properly load and use rotor.
- Do not exceed the allowable maximum speed of rotor, tube and adapters etc. Ensure the allowable maximum speed of adapters is lower than the rotor's maximum speed.



## 12.1 Rotor instructions

### 1) Rotor structure

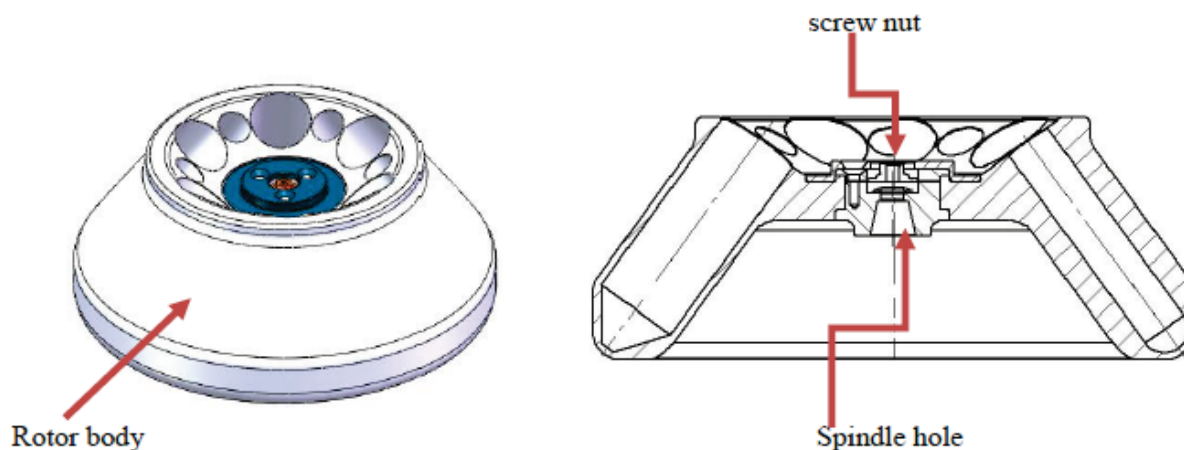

Figure 12-1 The rotor structure

### 2) Available rotors and adapters

Rotor type	Tubes	Tubes Per Rotor	Dimension (Φ×L mm)	Adapters	Maximum speed (rpm)	Radius cm	Maximum RCF (×g)
A6-50P	15ml con	6	17×120		4000	10	1800
	50ml vacu	6	30×118		4000	10	1800

Total 12-1 Rotors and adapters

### 3) Notice

- The centrifuge rotor can separate samples with a density lower than 2.0g/ml. If the samples density is over 2.0g/ml, please calculate allowable speed depending on the following formula.

$$\text{allow speed}(rpm) = \text{max speed} \times \sqrt{\frac{2.0(g/ml)}{\text{sample density}(g/ml)}}$$

### 4) Autoclaving

A12-10P rotor is made of plastic, cannot be high-pressure sterilization and UV irradiation, only ordinary sterilization can be used.

## 12.2 Tubes

### 1) Cleaning and sterilizing tubes

O: Applicable X: Inapplicable

Conditions	Materials	PA	PC	PP
— ○	Acidic (pH5 or lower)	X	X	X

	Cleaning fluids	Acidic (higher than pH5 )	O	O	O
		Alkaline (higher than pH9 )	O	X	O
		Alkaline (pH9 or lower)	O	O	O
		Neutral (pH7)	O	O	O
		Warm water(up to 70°C)	O	O	O
	Ultrasonic cleaning	Neutral detergent (pH7)	O	O	O
Sterilization	Autoclaving	115°C (0.7kg/cm <sup>2</sup> ) 30minutes	O	O	O
		121°C (1.0kg/cm <sup>2</sup> ) 20 minutes	X	O	O
		126°C (1.4kg/cm <sup>2</sup> ) 15 minutes	X	X	X
	Boiling	15 to 30 minutes	O	O	O
	Ultraviolet sterilization	200-300nm	X	X	X
	Gas sterilization	Ethylene oxide	O	X	O
Formaldehyde		O	O	O	

PA: Polyallomer PC: Polycarbonate PP: Polypropylene

Table 12-2 Cleaning and sterilizing conditions for tubes

## 2) Cleaning PC tubes

PC material is low in chemical resistance against alkaline solutions. Avoid using neutral detergents with pH higher than 9. Note that pH of some neutral detergents are still higher than 9 even if diluted according to the manufacturer's instructions. Use detergent with its pH between 7 and 9.

## 3) Autoclaving PA、PC and PP tubes

PA begins softening at about 120°C, PC and PP at about 130°C. Autoclave PA tubes at 115°C (0.7kg/cm<sup>2</sup>) for 30 minutes, PC and PP tubes at 121°C (0.1kg/cm<sup>2</sup>) for 20 minutes. If a certain temperature is exceeded, the tubes may be deformed.

When use a sterilizing chamber, please operate as follows:

- (1) Place tubes in vertical position, mouths upward. If tubes are placed sideways, they may deform into an oval shape due to gravity.
- (2) Remove locking nut and lid to prevent from deformation or rupture.
- (3) Wait until the sterilizing chamber cools down to the room temperature before removing tubes.

## 4) Conditions and life expectancy of tubes

The life expectancy of plastic tubes depends on the characteristics of samples, speed of the rotor used, temperature applied and so on. When the plastic tubes are used for ordinary aqueous samples (pH between 5.0 and 9.0), their life expectancies are defined as follows.

Be operated at the maximum speed:

High quality tubes (PA、PC、PP): 30-50 operations

Ordinary tubes(PA、 PC、 PP): around 10 operations (Using in low speed can extend the tube life) .  
Life expectancy of tubes also depends on the pretreatment conditions such as cleaning and sterilization, lifetime can be cut down.

**Notice: Do not use damaged or cracked tubes.**

## 13. Calculate RCF

An RCF can be determined with the following calculation formula.

$$RCF=1.118 \times r \times n^2 \times 10^{-5}$$

r—rotating radius, unit: cm; n—rotating speed, unit: rpm

## 14. Returning and Disposal

### 14.1 Returning Devices



Before returning the device, a transport securing device has to be installed.

If the device or its accessories are returned back, in order to provide protection for people, the environment and materials, it has to be decontaminated and cleaned before being shipped.

### 14.2 Disposal

Before disposal, the device must be decontaminated and cleaned to protect people, the environment and property. When you are disposing of the device, the respective statutory rules must be observed.

Pursuant to guideline 2002/96/EC (WEEE), all devices supplied after August 13,2005 may not be disposed as part of domestic waste. The device belongs to group 8 (medical devices) and is categorized in the business-to-business field.

The icon of the crossed-out trash can shows that the device may not be disposed as part of domestic waste. The waste disposal guidelines of the individual EC countries might vary. If necessary, contact your supplier.

## 15. Ordering information

Cat. No.	Model	Descriptions
9034002125	DM0412	Clinical Centrifuge with A6-50P rotor kits, CN plug, 100V-240V/50Hz/60Hz
<b>Accessories</b>		
19200316	A6-50P	Rotor kits, Max speed 4000rpm, Max capacity 50ml*6

## 16. Warranty

### 16.1 Warranty of centrifuge

This centrifuge is guaranteed for one years from the date of delivery provided that it has been operated and maintained properly.

### 16.2 Warranty of the rotor

The rotor is guaranteed for 5 years from the date of delivery upon manufacturer. Please pay attention, do not use the rotor once it has been corrosion or fatigue damage. The warranties of the centrifuge and the rotor become invalid in the case of the following conditions even if within the guarantee period expires:

- (1) Failures caused by incorrect installation.
- (2) Failures caused by rough or improper handling.
- (3) Failures caused by conveyance or relocation after installation.
- (4) Failures caused by unauthorized disassembly or modification.
- (5) Failures caused by using non-standard spare parts or accessories and unauthorized modification of the rotor or centrifuge.
- (6) Failures caused by natural disasters including fire, earthquakes and so on.
- (7) Consumables and parts have a limited guarantee period.

## After-sales service

In order to ensure to operate centrifuge safely and efficiently, it is necessary for regular maintenance. If centrifuge has problems, do not attempt to repair it by yourself. Contact our sales or service center.