



HLR-310FL

Laboratory Refrigerator

Scope of Application:

This product is suitable for storing inflammable and explosive reagents in laboratories of universities and scientific research institutes

Innovative Design

- ⊙ Explosion Proof Fan
- ⊙ Setting Temperature Range +3°C to +16°C
- ⊙ Energy Star® Certified
- ⊙ 360° Explosion Proof Interior
- ⊙ ATEX Certified

Qingdao Haier Biomedical Co.,Ltd.

No.280 Feng Yuan Road, High-tech Zone,
Qingdao, 266109, P.R. China
Tel: +86-0532-88935593
E-mail: inquiry@haierbiomedical.com
Website: www.haiermedical.com



Haier Biomedical
International



Haier Biomedical
International



@haiermedicalint









Haier Biomedical
International



Haier Biomedical
International

Product Advantages

-  **ATEX II C-T6 EU Explosion Proof Certified**
Our 360° all-around explosion proof system uses an antistatic liner, gasket and explosion proof fan motor. It is also equipped with an overcurrent and overvoltage protection system. All components within the unit are earthed to ensure static is discharged safely.
-  **Energy Efficient Design**
The hydrocarbon cooling system doubles the cooling efficiency and saves half the energy when compared to traditional refrigerants. In addition, the cabinet is fitted with an energy saving explosion proof fan.
-  **Clear and Complete Alarm System with One Key Search**
Multiple alarms and data function which allows users to check and save historical data, useful and convenient for laboratory inspection processes.
-  **Setting Temperature Range +3°C to +16°C**
The setting temperature can be adjusted within the range of 3°C to 16°C to meet multi-temperature storage requirements. With precise control, the internal temperature variation can be kept within 3°C for great temperature uniformity.
-  **Safe and Secure**
Built-in lock and adapter kit to allow users to add a padlock. Lockable control panel to prevent anyone turning off the unit by mistake or adjusting the temperature by accident.
-  **Multiple Alarms**
The refrigerator comes with high/low temperature alarm, door ajar alarm, sensor error alarm.

Product Introduction

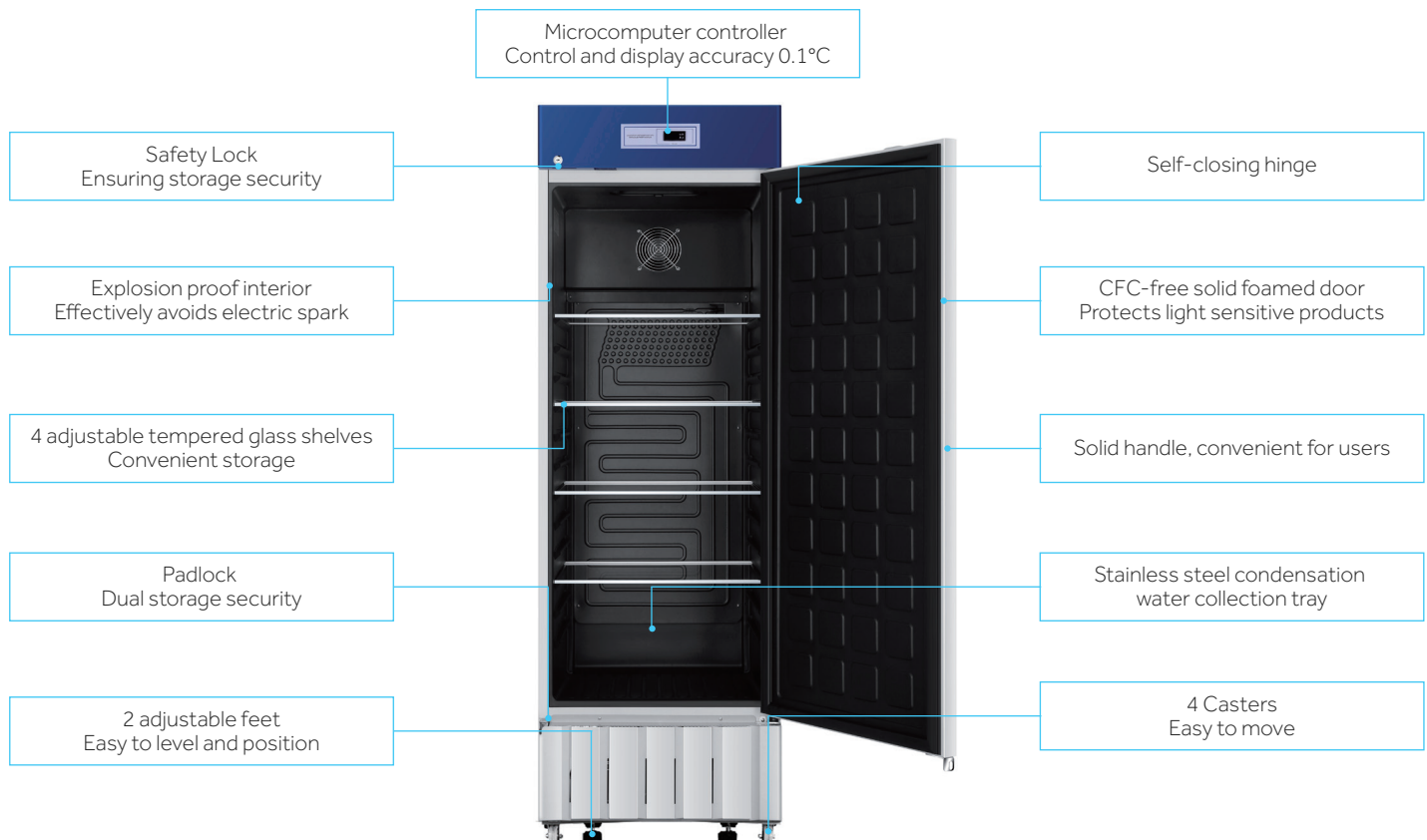

Temperature Curve



Cooling Down Curve

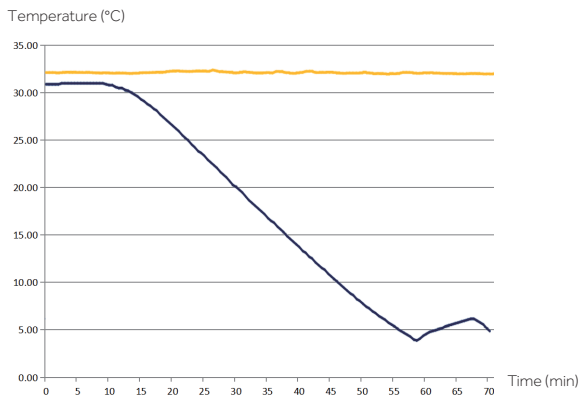

Stability Curve

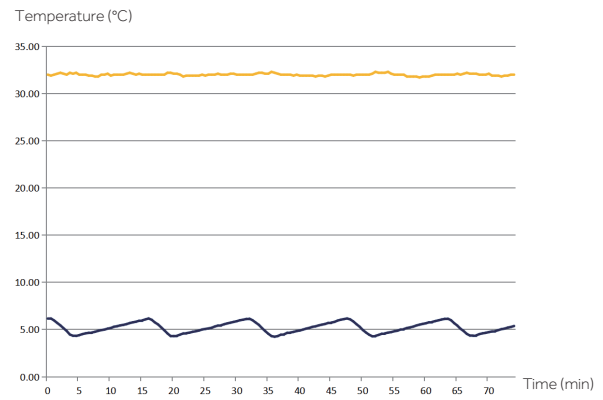

— Internal Temperature
— Ambient Temperature

Product Dimensions

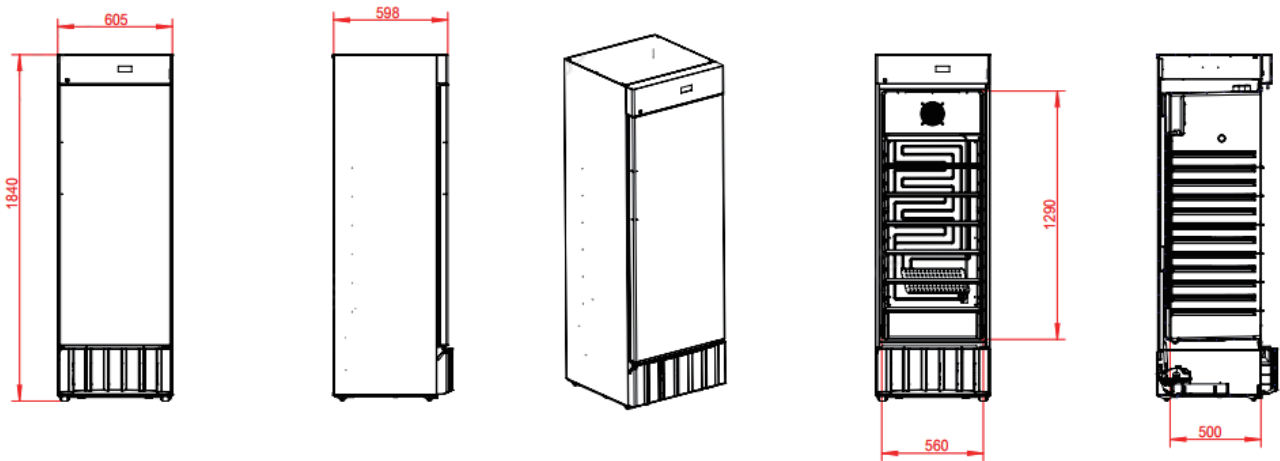

Specifications



Model		HLR-310FL	
Technical Data	Type	Upright	
	Climate Class	N	
	Cooling Type	Forced Air Cooling	
	Defrost Mode	Auto	
	Refrigerant	R600a, 40g	
	Sound Level (dB(A))	43	
Performance	Temperature Range (°C)	3-16 Adjustable	
	Ambient Temperature (°C)	16-32	
Control	Controller	Microprocessor	
	Display	LED	
Electrical Data	Power Supply (V/HZ)	115/60	
	Power (W)	210	
	Electrical Current (A)	2.5	
Dimension	Capacity (L/Cu.Ft)	310/10.9	
	Net/Gross Weight (approx)	kg	72/83
		lbs	158.7/183
	Interior Dimensions (W*D*H)	mm	560*500*1290
		in	22.0*19.7*50.8
	Exterior Dimensions (W*D*H)	mm	605*598*1840
		in	23.8*23.6*73.6
	Packing Dimensions (W*D*H)	mm	660*670*2020
in		26*26.4*79.5	
Container Load (20'/40'/40'H)		24/51/51	
Alarms	High/Low Temperature	Y	
	Sensor Error	Y	
	Door Ajar	Y	
Accessories	Caster	4	
	Foot	2	
	Shelves/Baskets	4/0	
	Water tray	1	
	Padlock Adapter Kit/Quantity	1	
	Built-in Key Door Lock/Quantity	1	
Others	Certification	UL, ATEX, Energy star	

*Haier Biomedical reserves the right to change products and specifications without prior notice.