

HI98190, HI98191

Calibration Check
Waterproof
pH/mV/ISE/Temperature Meters



INSTRUCTION MANUAL

Dear Customer,

Thank you for choosing a Hanna Instruments product.

Please read this instruction manual carefully before using the instrument.

This manual will provide you with the necessary information for correct use of the instrument, as well as a precise idea of its versatility.

If you need additional technical information, do not hesitate to e-mail us at tech@hannainst.com or view our worldwide contact list at www.hannainst.com.

All rights are reserved. Reproduction in whole or in part is prohibited without the written consent of the copyright owner, Hanna Instruments Inc., Woonsocket, Rhode Island, 02895, USA.

PRELIMINARY EXAMINATION	4
GENERAL DESCRIPTION	5
FUNCTIONAL DESCRIPTION	6
HI98190 SPECIFICATIONS	8
HI98191 SPECIFICATIONS	9
OPERATIONAL GUIDE	10
pH CALIBRATION	14
pH BUFFER TEMPERATURE DEPENDENCE	23
RELATIVE MV CALIBRATION	24
ISE CALIBRATION HI98191	25
GOOD LABORATORY PRACTICE (GLP)	29
SETUP	31
LOGGING	44
AUTOEND	45
mV AND TEMPERATURE CALIBRATION (FOR TECHNICAL PERSONNEL ONLY)	46
PC INTERFACE	49
BATTERIES REPLACEMENT	54
TEMPERATURE CORRELATION FOR pH SENSITIVE GLASS	55
ELECTRODE CONDITIONING AND MAINTENANCE	56
TROUBLESHOOTING GUIDE	58

Remove the instrument from the packing material and examine it carefully to make sure that no damage has occurred during shipping. If there is any damage, please contact your local Hanna Instruments Office.

Each instrument is supplied with:

- [HI12963](#) Amplified Combined pH temperature electrode ([HI98190](#))
- [HI72911B](#) Combined pH temperature electrode ([HI98191](#))
- [HI7662](#) Temperature Probe ([HI98191](#))
- pH 4.01 & 7.01 Buffer Solutions (230 mL each)
- [HI700601](#) General Purpose Cleaning Solution (3 pcs.)
- 100 mL Plastic Beaker (2 pcs.)
- 1.5V AA Batteries (4 pcs.)
- [HI920015](#) Micro USB cable
- Instruction Manual and Quick Reference Guide
- Certificate

Note: Save all packing material until you are sure that the instrument functions correctly. All defective items must be returned in the original packing with the supplied accessories.

The [HI98190](#) and [HI98191](#) instruments are state-of-the-art, heavy-duty pH meters, designed to provide laboratory results and accuracy under harsh industrial conditions.

They are provided with a series of new diagnostic features which add an entirely new dimension to the measurement of pH, by allowing the user to dramatically improve the reliability of the measurement:

- seven standard buffers (pH 1.68, 4.01, 6.86, 7.01, 9.18, 10.01 and 12.45) for calibration.
- pH calibration up to five calibration points (see instrument specifications).
- Custom calibration with up to five custom buffers.
- Messages on the graphic LCD for an easy and accurate calibration.
- Cal Check™ Diagnostic features to alert the user when the electrode needs cleaning.
- Optional user enabled “Outside Calibration Range” warning.
- Monitoring of the electrode aging.
- User selectable “Calibration Time Out” to remind when a new calibration is necessary.

Moreover, they offer an extended temperature range from -20 to 120 °C (-4 to 248 °F), using a temperature sensor inside pH electrode.

These instruments can also measure with ORP electrodes, thanks to their capability to measure mV with a resolution up to 0.1 mV.

[HI98191](#) can also measure with ISE electrodes. The electrode type unit selection capability and the ISE calibration in up to five calibration standard solutions make this instrument very useful for a large range of concentration solutions measurements.

Other features include:

- Relative mV measurements
- Log on demand up to 300 samples for [HI98191](#) and 200 samples for [HI98190](#) (100 samples on each range - pH, mV, ISE only [HI98191](#))
- Auto Hold feature, to freeze first stable reading on the LCD
- GLP feature, to view last calibration data for pH, Rel mV, or ISE
- PC interface

FRONT VIEW

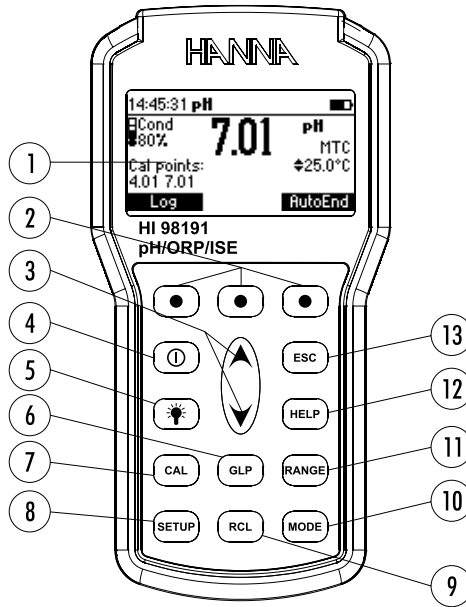

- 1) Liquid Crystal Display (LCD).
- 2) Functional keys.
- 3) ▲/▼ keys to manually increase/decrease the parameters or to scroll between the parameter list.
- 4) **ON/OFF** (Ⓞ) key, to turn the instrument ON and OFF.
- 5) **LIGHT** (☀) key to toggle display backlighting.
- 6) **GLP** key, to display Good Laboratory Practice information.
- 7) **CAL** key, to enter/exit calibration mode.
- 8) **SETUP** key, to enter/exit SETUP mode.
- 9) **RCL** key, to enter/exit view logged data mode.
- 10) **MODE** key to change pH resolution or to toggle between mV and Rel mV mode.
- 11) **RANGE** key, to switch between pH and mV range (HI98190) or pH, mV and ISE range (HI98191).
- 12) **HELP** key to enter/exit contextual help.
- 13) **ESC** to leave current mode, exit calibration, setup, help. etc.

TOP VIEW HI98190

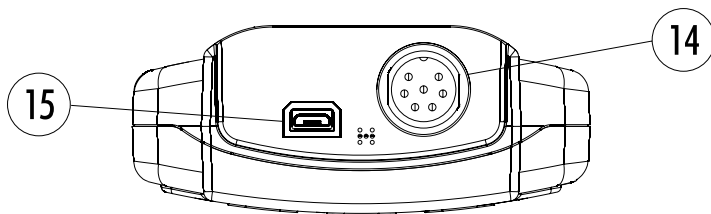

14) Electrode **DIN** connector.

15) USB connector.

TOP VIEW HI98191

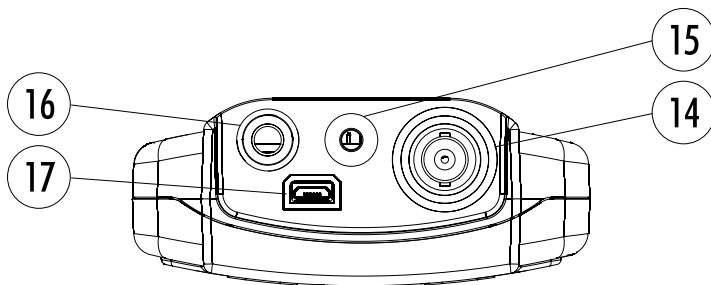

14) BNC electrode connector.

15) Input for Reference electrode.

16) Input for Temperature probe.

17) USB Connector.

pH	Range	-2.0 to 20.0 pH / -2.00 to 20.00 pH / -2.000 to 20.000 pH
	Resolution	0.1 pH / 0.01 pH / 0.001 pH
	Accuracy	± 0.1 pH / ± 0.01 pH / ± 0.002 pH
mV	Range	± 2000 mV
	Resolution	0.1 mV
	Accuracy	± 0.2 mV
Temperature	Range	-20.0 to 120.0 °C (-4.0 to 248.0 °F)
	Resolution	0.1 °C (0.1 °F)
	Accuracy	± 0.4 °C (± 0.8 °F) (excluding probe error)
Rel mV Offset Calibration		± 2000 mV
pH Calibration		Up to five point calibration, seven standard buffers available (pH 1.68, 4.01, 6.86, 7.01, 9.18, 10.01, 12.45), and five custom buffers
Slope Calibration		From 80 to 110%
Temperature Compensation		Manual or Automatic from -20.0 to 120.0 °C (-4.0 to 248.0 °F)
pH Electrode		HI12963 pH & temperature
LOG		On demand, 200 samples (100 samples on each range)
Input Impedance		10^{12} Ω
Battery Type/Life		1.5V AA batteries (4 pcs.) / approx. 200 hours of continuous use without backlight (50 hours with backlight)
Auto Power Off		User selectable: 5, 10, 30, 60 minutes or disabled
PC Interface		opto-isolated USB
Dimensions		185 x 93 x 35.2 mm (7.3 x 3.6 x 1.4")
Weight		400 g (14.2 oz)
Environment		0 to 50 °C (32 to 122 °F) max. RH 100% IP67

pH	Range	-2.0 to 20.0 pH / -2.00 to 20.00 pH / -2.000 to 20.000 pH
	Resolution	0.1 pH / 0.01 pH / 0.001 pH
	Accuracy	± 0.1 pH / ± 0.01 pH / ± 0.002 pH
mV	Range	± 2000 mV
	Resolution	0.1 mV
	Accuracy	± 0.2 mV
ISE	Range	From 1.00 E^{-7} to 9.99 E^{10} concentration
	Resolution	3 digits 0.01, 0.1, 1, 10 concentration
	Accuracy	$\pm 0.5\%$ of reading (monovalent ions) $\pm 1\%$ of reading (divalent ions)
Temperature		-20.0 to 120.0 °C (-4.0 to 248.0 °F)
Rel mV Offset Range		± 2000 mV
pH Calibration		Up to five point calibration, seven standard buffers available (pH 1.68, 4.01, 6.86, 7.01, 9.18, 10.01, 12.45), and five custom buffers
Slope Calibration		From 80 to 110%
ISE Calibration		Up to five point calibration points six standard solutions available (0.1, 1, 10, 100, 1000, 10000 ppm)
Temperature Compensation		Manual or Automatic from -20.0 to 120.0 °C (-4.0 to 248.0 °F)
pH Electrode		HI72911B pH & temperature (included)
LOG		On demand, 300 samples (log samples on each range)
Input Impedance		$10^{12} \Omega$
Battery Type/Life		1.5V AA batteries (4 pcs.) / approx. 200 hours of continuous use without backlight (50 hours with backlight)
Auto Power Off		User selectable: 5, 10, 30, 60 minutes or disabled
PC Interface		opto-isolated USB
Dimensions		185 x 93 x 35.2 mm (7.3 x 3.6 x 1.4")
Weight		400 g (14.2 oz)
Environment		0 to 50 °C (32 to 122 °F) max. RH 100% IP67

INITIAL PREPARATION

The instrument is supplied complete with 1.5V AA (4 pcs.) batteries. For placing the batteries inside the meter, see page 54.

To prepare the instrument for field measurements close the serial communication socket and all unused connector sockets with proper stopper (to ensure waterproof protection). Use the holed temperature rubber cork for the temperature socket when temperature probe is connected.

For [HI98191](#) connect the pH electrode and the temperature probe to the BNC and temperature sockets on the top of the instrument. Push the pH electrode sleeve to cover the connector accommodation.

The temperature probe is used in conjunction with the pH electrode to utilize the instrument's ATC capability, but it can also be used independently to take temperature measurements. If the probe is disconnected, temperature can be set manually with the ▲/▼ keys.

For [HI98190](#) connect the pH/temperature electrode to the DIN connector.

Turn the instrument ON by pressing **ON/OFF** key.

At start-up the display will show the Hanna Instruments logo for a few seconds followed by the percentage indication of the remaining battery life, then enters the measurement mode.

After measurement switch the instrument off, clean the electrode and store it with a few drops of [HI70300](#) storage solution in the protective cap (see page 57).

The Auto Power Off feature turns the instrument off after a set period (default 30 min) with no button pressed to save battery life. To set another period or to disable this feature, see **SETUP** menu on page 31.

The Auto Light Off backlight feature turns the backlight off after a set period (default 1 min) with no buttons pressed. To set another period or to disable this feature, see **SETUP** menu on page 31.

pH MEASUREMENTS

To take a pH measurement remove the electrode protective cap and simply submerge the tip of the electrode (4 cm/1 1/2") into the sample to be tested.

Press **RANGE** key until the display changes to the pH range, if necessary.

Use **MODE** key to select the pH resolution.

Allow for the electrode to adjust and reading to stabilize (hourglass symbol turns off).

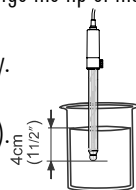

On the pH screen are displayed:

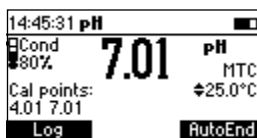

- pH reading with the selected resolution.
- Temperature reading in the selected unit (°C or °F).
- Temperature compensation mode (MTC - manual, ATC - automatic). While in MTC mode the \blacklozenge indicate that the temperature can be manually changed using \blacktriangle / \blacktriangledown keys.
- Electrode condition during the calibration day.
- The buffers used in last pH calibration (if feature is enabled in **SETUP**).
- Battery level indicator.
- Available functional keys in accordance with the model.

In order to take more accurate pH measurements, make sure that the instrument is calibrated (see page 14 for calibration details).

It is recommended that the electrode is always kept moist and rinsed thoroughly with the sample to be measured before use.

The pH reading is directly affected by temperature. For accurate pH measurements, temperature must be taken into consideration. If the sample temperature is different from the temperature at which the pH electrode was kept, allow a few minutes to reach thermal equilibrium.

To use the instrument's Automatic Temperature Compensation (ATC) feature, submerge the temperature probe into the sample as close to the electrode as possible and wait for a few seconds.

If manual temperature compensation (MTC) is desired, the temperature probe must be disconnected from the instrument (HI98191 only).

The display will show the default temperature of 25 °C, the last measured temperature reading, or the last set temperature, with the "MTC" indication.

The "MTC" indication and the \blacklozenge symbol light up on the LCD to indicate that the instrument is in MTC mode and the \blacktriangle / \blacktriangledown keys can be used to enter the desired temperature value.

Note: When in MTC the user can press and hold the \blacktriangle / \blacktriangledown keys, and the instrument will start incrementing /decrementing the temperature value. The instrument keeps measuring and the display is updated periodically.

ORP MEASUREMENTS

To perform ORP measurements, connect an optional ORP electrode to the instrument and turn it ON. Press **RANGE** key until mV range is displayed, if necessary.

Submerge the ORP electrode tip (4 cm/1½") into the sample to be tested and wait a few seconds for the reading to stabilize.

Measurements are displayed with 0.1 mV resolution.

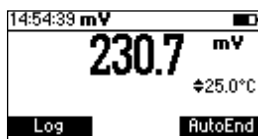

The "ATC" (or "MTC") message is turned off because mV readings are not temperature compensated.

For accurate ORP measurements, the surface of the electrode must be clean and smooth. Pretreatment solutions are available to condition the electrode and improve its response time.

RELATIVE mV MEASUREMENTS

To enter Relative mV mode, press **MODE** while in mV measurement mode. The relative mV reading will be displayed along with the Absolute mV value and the current temperature readings.

The relative mV reading is equal to the difference between the absolute mV input value and relative mV offset established in the relative mV calibration.

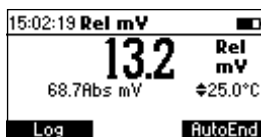

Note: If using the pH electrode while in mV mode, the instrument will measure the mV generated by the pH electrode.

ISE MEASUREMENTS (HI98191 only)

To perform ion concentration measurements, connect an optional ISE electrode and the corresponding reference (if necessary) to the instrument and turn it ON.

Enter the ISE mode by pressing **RANGE** until the display changes to ISE range.

Submerge the ISE electrode tip (4 cm/1½") into the sample to be tested and wait a few seconds for the reading to stabilize.

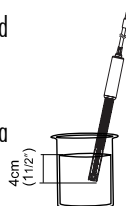

The ISE reading will be displayed along with the current temperature reading.

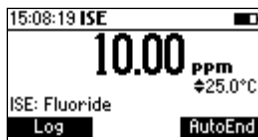

The “ATC” (or “MTC”) message is turned off because ppm readings are not temperature compensated.

In order to take accurate ISE measurements, make sure that the appropriate ISE electrode type and ISE unit were set in **SETUP** menu and the instrument was calibrated (see ISE CALIBRATION for details, page 25).

Notes: When the reading is out of range, the display will flash the closest full-scale value. The instrument will display “----” on the primary LCD if it is not calibrated. Perform at least a one point calibration in order to take ISE measurements. Changing the ISE electrode or the ion charge will need ISE range calibration.

TEMPERATURE MEASUREMENTS

For **HI98190** the temperature sensor is connected through DIN socket.

Connect the temperature connector to the appropriate socket (**HI98191**). Immerse the pH electrode into the sample and allow the reading on the secondary LCD to stabilize.

Note: The temperature can be displayed in Celsius degrees (°C) or in Fahrenheit degrees (°F) (see SETUP for details, page 31).

BACKLIGHT FEATURE

The instrument is provided with a Backlight feature, which can be easily toggled on and off through the keyboard by pressing **LIGHT**.

Note: The backlight automatically shuts off after a set period (see SETUP for details, page 31) with no buttons pressed.

It is recommended to calibrate the instrument frequently, especially if high accuracy is required. The pH range should be recalibrated:

- Whenever the pH electrode is replaced.
- At least once a week.
- After testing aggressive chemicals.
- When calibration alarm time out is expired - “CAL DUE” blinks (if feature is enabled in **SETUP**).
- If “**Outside Cal Range**” message blinks during pH measurement (the measurement range is not covered by current calibration, if feature is enabled in **SETUP**).

PROCEDURE

HI98190 and HI98191 instruments offers a choice of seven standard buffers (pH 1.68, 4.01, 6.86, 7.01, 9.18, 10.01 and 12.45). The meters allow the user to set up to five custom buffers. The set custom buffers are the buffer values at 25 °C.

When a custom buffer is selected during calibration, the **Custom** functional key is displayed on the LCD. Press **Custom** key in order to enter custom buffer changing mode. Use ▲/▼ keys to change the value in a ± 1.00 pH window, in according with the temperature reading and then **Accept**. Press **ESC** to leave custom buffers value unchanged.

For accurate pH measurements, it is recommended to perform a calibration in maximum allowed points. However, at least a two point calibration is suggested.

The instrument will automatically skip the buffers used during calibration and the buffers which are in a ± 0.2 pH window around one of the calibrated buffers.

- Pour small quantities of selected buffer solutions into clean beakers. For accurate calibration use two beakers for each buffer solution, the first one for rinsing the electrode and the second one for calibration.
- Remove the protective cap and rinse the electrode with some of the buffer solution to be used for the first calibration point.

FIVE POINT CALIBRATION

- Immerse the pH electrode approximately 4 cm (1½”) into a buffer solution of your choice (pH 1.68, 4.01, 6.86, 7.01, 9.18, 10.01, 12.45 or a custom buffer) and stir gently. The temperature probe (HI98191 only) should be close to the pH electrode.

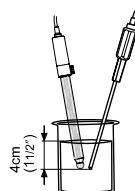

- Press **CAL**. The instrument will display the measured pH, the LCD first expected buffer and the temperature reading.

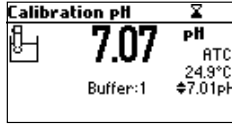

- If necessary, press the ▲/▼ keys to select a different buffer value.
- The "Σ" tag will blink on the LCD until the reading is stable.
- When the reading is stable and within range of the selected buffer, **CFM** functional key is displayed.

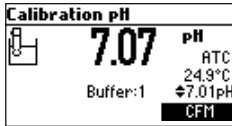

- Press **CFM** to confirm first point.
- The calibrated value and the second expected buffer value is then displayed on the LCD.

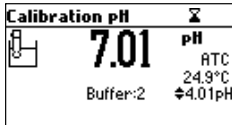

- After the first calibration point is confirmed, immerse the pH electrode and the temperature probe approximately 4 cm (1½") into the second buffer solution and stir gently. The temperature probe should be close to the pH electrode.
- If necessary, press the ▲/▼ keys to select a different buffer value.
- The "Σ" tag will blink on the LCD until the reading is stable.

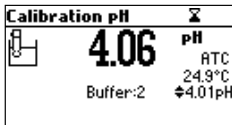

- When the reading is stable and within range of the selected buffer, the **CFM** functional key is displayed.

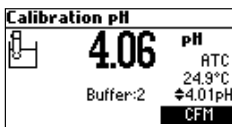

- Press **CFM** to confirm calibration.
- The calibrated value and the third expected buffer value will be displayed.

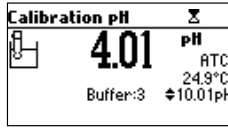

- After the second calibration point is confirmed, immerse the pH electrode and the temperature probe approximately 4 cm (1½") into the third buffer solution and stir gently. The temperature probe should be close to the pH electrode.

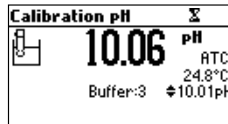

- If necessary, press the ▲/▼ keys to select a different buffer value.
- The "Σ" tag will blink on the LCD until the reading is stable.
- When the reading is stable and within range of the selected buffer, the **CFM** functional key is displayed.

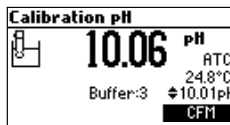

- Press **CFM** to confirm calibration.
- The calibrated value and the fourth expected value will be displayed.

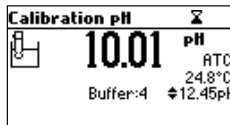

- After the third calibration point is confirmed, immerse the pH electrode and the temperature probe approximately 4 cm (1½") into the fourth buffer solution and stir gently. The temperature probe should be close to the pH electrode.
- If necessary, press the ▲/▼ keys to select a different buffer value.
- The "Σ" tag will blink on the LCD until the reading is stable.

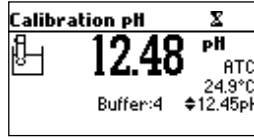

- When the reading is stable and within range of the selected buffer, the **CFM** functional key is displayed.

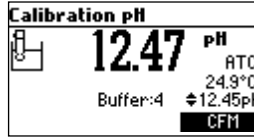

- Press **CFM** to confirm calibration.

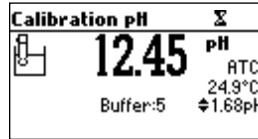

- The calibrated value and the fifth expected buffer will be displayed.
- After the fourth calibration point is confirmed, immerse the pH electrode and the temperature probe approximately 4 cm (1½") into the fifth buffer solution and stir gently. The temperature probe should be close to the pH electrode.

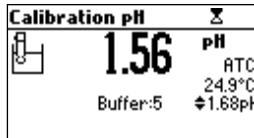

- If necessary, press the ▲/▼ keys to select a different buffer value.
- The "Σ" tag will blink on the LCD until the reading is stable.
- When the reading is stable and within range of the selected buffer, the **CFM** functional key is displayed.

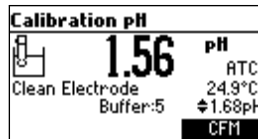

- Press **CFM** to confirm calibration.
- The instrument stores the calibration values and returns to normal measurement mode.

FOUR, THREE or TWO POINT CALIBRATION

- Proceed as described in “FIVE POINT CALIBRATION” section.
- Press **CAL** or **ESC** after the appropriate accepted calibration point. The instruments will return to measurement mode and will memorize the calibration data.

ONE POINT CALIBRATION

Two **SETUP** selectable options are available for one point calibration: **Replace** and **Offset**.

If the **Replace** option is selected, the slopes between current buffer and nearest lower and higher buffers will be reevaluated.

If the “**Offset**” option is selected, an electrode offset correction is performed keeping unchanged the existing slopes.

- Proceed as described in “FIVE POINT CALIBRATION” section.
- Press **CAL** or **ESC** after the first calibration point was confirmed. The instruments will memorize the one point calibration data and will return to measurement mode.

Notes: Press MTC or MODE key to toggle between pH buffer selection and the temperature reading during calibration while temperature probe is not connected (MTC mode).

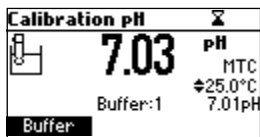

The displayed arrow is moving to the temperature value. Use ▲/▼ keys in order to change the temperature.

ERROR SCREENS

Wrong buffer

The calibration cannot be confirmed.

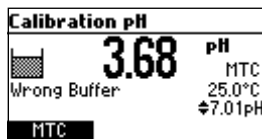

The pH reading is not within range of the selected buffer. Select another buffer using the ▲/▼ keys or change the buffer.

Electrode Dirty/Broken alternatively with Buffer Contaminated

The calibration cannot be confirmed.

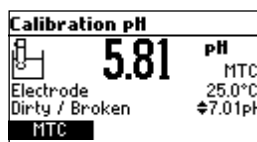
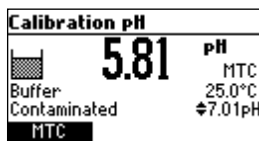

The offset of the electrode is not in the accepted range. Check if the electrode is broken or clean it following the Cleaning Procedure (see page 57). Check the quality of the buffer. If necessary, change the buffer.

Wrong slope

The calibration cannot be confirmed.

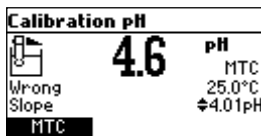

The evaluated slope is less than the lowest accepted value (80% of default slope).

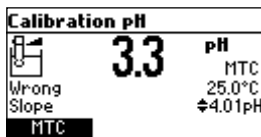

The evaluated slope is more than the highest accepted value (110 % of default slope).

Wrong old slope

An inconsistency between new and previous (old) calibration is detected. Clear old calibration parameters and proceed with the calibration from the current point. The instrument will keep all confirmed values during current calibration.

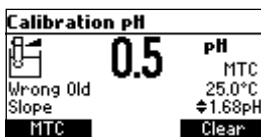

Note: For one point calibration the electrode condition is not displayed in the measurement screen. Each time a buffer is confirmed, the new calibration parameters replace the old calibration parameters of the corresponding buffer.

If the current confirmed buffer has no correspondence in the existing stored calibration and this is not full, the current buffer is added to the existing stored calibration.

If the existing stored calibration is full (five calibration points), after confirming the calibration point, the instrument will ask which buffer will be replaced by current buffer.

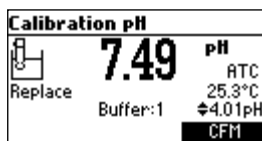

Press ▲/▼ keys to select another buffer to be replaced.

Press **CFM** to confirm the buffer that will be replaced.

Press **CAL** or **ESC** to leave replace mode. In this case, the buffer will not be memorized.

Note: The replaced buffer is not removed from calibration list and it can be selected for the next calibration points.

WORKING WITH CUSTOM BUFFERS

If at least one custom buffer was set in **SETUP** menu, it can be selected for calibration by pressing the ▲/▼ keys. The **Custom** functional key will be displayed.

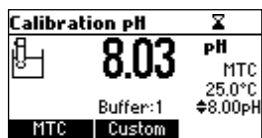

Press **Custom** if you want to adjust the buffer value according with current temperature.

Use the ▲/▼ keys to change the buffer value.

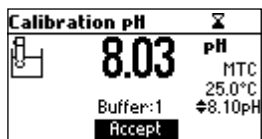

Press **Accept** to accept new value or **ESC** to exit changing mode.

Note: Custom buffer value can be adjusted in a ±1.00 pH window, around the set value.

WORKING WITH MILI pH BUFFERS

If calibration is invoked from mili pH range, the calibration buffer can be modified in a ± 0.020 pH range in according with the label on the calibration buffer.

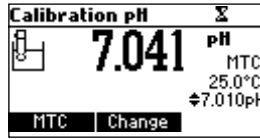

Press **Change** to enter buffer adjust mode.

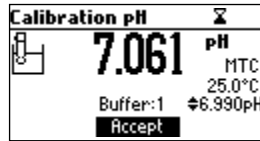

Use $\blacktriangle/\blacktriangledown$ keys to change the buffer value.

Press **Accept** to accept new value or **ESC** to exit adjusting mode.

CLEAR CALIBRATION

Press **Clear** functional key when displayed to clear old calibrations.

All old calibrations, are cleared and the instrument continues calibration. The points confirmed in current calibration are kept.

Note: If Clear calibration is invoked during the first calibration point, the instrument returns to measurement mode.

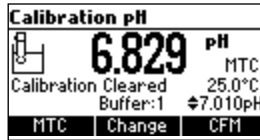

ELECTRODE CONDITION

The display is provided with an icon, and a numeric value (unless the feature is disabled) which gives an indication of the electrode status after calibration.

The “condition” remains active until the end of the calibration day.

Note: The electrode condition is evaluated only if current calibration includes at least two standard buffers.

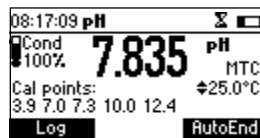

CLEAN ELECTRODE WARNING

Each time pH calibration is performed, the instrument internally compares the new calibration with the one previously stored.

When this comparison indicates a significant difference, the “**Clean Electrode**” warning message is displayed to advise the user that the pH electrode may need to be cleaned (see ELECTRODE CONDITIONING AND MAINTENANCE section for details, page 56).

Calibration pH		
	6.829	pH
Calibration Cleared		MTC
Buffer:1		25.0°C
		±7.010pH
MTC	Change	CFM

After cleaning, perform a new calibration.

Note: If the calibration data are cleared, the comparison is done with the default values.

The temperature has an effect on pH. The calibration buffer solutions are affected by temperature changes to a lesser degree than normal solutions. During calibration the instrument will automatically calibrate to the pH value corresponding to the measured or set temperature.

TEMP		pH BUFFERS						
°C	°F	1.68	4.01	6.86	7.01	9.18	10.01	12.45
0	32	1.67	4.01	6.98	7.13	9.46	10.32	10.38
5	41	1.67	4.00	6.95	7.10	9.39	10.25	13.18
10	50	1.67	4.00	6.92	7.07	9.33	10.18	12.99
15	59	1.67	4.00	6.90	7.05	9.27	10.12	12.80
20	68	1.68	4.00	6.88	7.03	9.22	10.06	12.62
25	77	1.68	4.01	6.86	7.01	9.18	10.01	12.45
30	86	1.68	4.02	6.85	7.00	9.14	9.96	12.29
35	95	1.69	4.03	6.84	6.99	9.11	9.92	12.13
40	104	1.69	4.04	6.84	6.98	9.07	9.88	11.98
45	113	1.70	4.05	6.83	6.98	9.04	9.85	11.83
50	122	1.71	4.06	6.83	6.98	9.01	9.82	11.70
55	131	1.72	4.08	6.84	6.98	8.99	9.79	11.57
60	140	1.72	4.09	6.84	6.98	8.97	9.77	11.44
65	149	1.73	4.11	6.84	6.99	8.95	9.76	11.32
70	158	1.74	4.12	6.85	6.99	8.93	9.75	11.21
75	167	1.76	4.14	6.86	7.00	8.91	9.74	11.10
80	176	1.77	4.16	6.87	7.01	8.89	9.74	11.00
85	185	1.78	4.17	6.87	7.02	8.87	9.74	10.91
90	194	1.79	4.19	6.88	7.03	8.85	9.75	10.82
95	203	1.81	4.20	6.89	7.04	8.83	9.76	10.73

During calibration the instrument will display the pH buffer value at 25 °C.

- Press **CAL** when the instrument is in **RELATIVE mV** measurement mode. The relative mV value and the temperature values are displayed.
- Use the **▲/▼** keys if you want to change the displayed relative mV value.

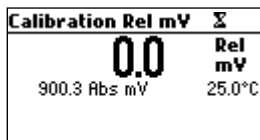

- When the reading is stable, in mV range and the Relative mV offset is inside the offset window (± 2000 mV), **CFM** functional key is displayed.

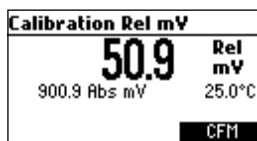

- Press **CFM** to confirm relative mV calibration. The instrument will return to measurement mode.
- If the absolute mV reading is out of range or the Relative mV offset is out of the offset window, **“Wrong relative offset”** message is displayed.

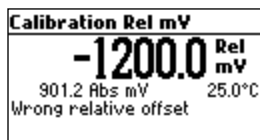

Change the input value or the Relative mV value to complete the calibration process.

It is recommended to calibrate the instrument frequently, especially if high accuracy is required. The ISE range should be recalibrated:

- Whenever the ISE probe or ion charge is changed.
- At least once a week.
- After testing aggressive chemicals.
- When calibration alarm time out is expired- "CAL DUE" tags blinks (if feature is enabled).

Due to electrode conditioning time, the electrode must be kept immersed a few seconds to stabilize. The user will be guided step by step during calibration with easy to follow tags on the LCD. This will make the calibration a simple and error-free procedure.

PROCEDURE

Select the proper ISE probe in **SETUP** menu or select the proper Ion Charge (see **SETUP** for details, page 31).

Note: If ISE probe is not calibrated in at least one point, the "----" will be displayed.

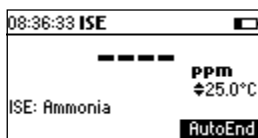

Pour small volumetrically measured 50 mL of calibration standard solutions and transfer into clean beakers. If possible, use plastic beakers to minimize any EMC interferences.

For accurate calibration and to minimize cross-contamination, use two beakers for each standard solution. One for rinsing the electrode and one for calibration.

The instrument offers a choice of six memorized standard solutions: 0.1, 1, 10, 100, 1000, 10000 ppm and calibration up to five points. For fluoride electrode the 2 ppm standard is also available.

Remove the protective cap from the ISE electrode.

FIVE POINT CALIBRATION

- Immerse the ISE electrode approximately 4 cm (1½") into the less concentrated standard solution and stir gently.

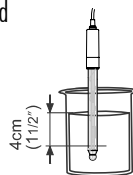

- Press **CAL**. The primary LCD will display the ion concentration in the selected unit or “---” if not calibrated and first standard value.

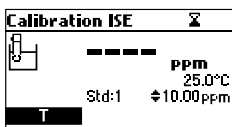

- If necessary, press the ▲/▼ keys to select a different standard value.
- The “⌘” tag will blink on the LCD until the reading is stable.
- When the reading is stable and within range of the selected standard, the **CFM** functional key is displayed.

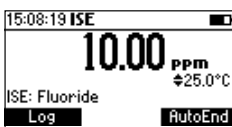
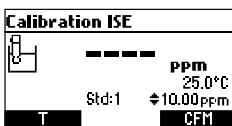

- Press **CFM** to confirm calibration.
- The calibrated value and the second expected standard value will be displayed.
- After the first calibration point is confirmed, immerse the ISE electrode approximately 4 cm (1½”) into the second calibration solution.
- If necessary, press the ▲/▼ keys to select a different standard value.
- The “⌘” tag will blink on the LCD until the reading is stable.
- When the reading is stable and within range of the selected standard, the **CFM** functional key is displayed.
- Press **CFM** to confirm calibration.
- The calibrated value and the third expected standard value will be displayed.
- After the second calibration point is confirmed, immerse the ISE electrode approximately 4 cm (1½”) into the third calibration solution.
- If necessary, press the ▲/▼ keys to select a different standard value.
- The “⌘” tag will blink on the LCD until the reading is stable.
- When the reading is stable and within range of the selected standard, the **CFM** functional key is displayed.
- Press **CFM** to confirm calibration.

- The calibrated value and the fourth expected standard value will be displayed.
- After the third calibration point is confirmed, immerse the ISE electrode approximately 4 cm (1½") into the fourth calibration solution.
- If necessary, press the ▲/▼ keys to select a different standard value.
- The "⌘" tag will blink on the LCD until the reading is stable.
- When the reading is stable and within range of the selected standard, the **CFM** functional key is displayed.
- Press **CFM** to confirm calibration.
- The calibrated value and the fifth expected standard value will be displayed.
- After the fourth calibration point is confirmed, immerse the ISE electrode approximately 4 cm (1½") into the fifth calibration solution.
- If necessary, press the ▲/▼ keys to select a different standard value.
- The "⌘" tag will blink on the LCD until the reading is stable.
- When the reading is stable and within range of the selected standard, the **CFM** functional key is displayed.
- Press **CFM** to confirm calibration. The instrument stores the calibration value and returns to normal measurement mode.

Note: The instrument will automatically skip the standard solutions used during calibration.

FOUR, THREE, TWO or ONE POINT CALIBRATION

- Proceed as described in "FIVE POINT CALIBRATION" section.
- Press **ESC** or **CAL** key after the appropriate accepted calibration point. The instruments will return to measurement mode and will memorize the calibration data.

ERROR SCREENS

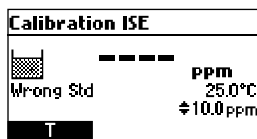

Wrong standard

The calibration cannot be confirmed.

The message appears if mV input is out of ± 2000 mV range.

Wrong slope

The calibration cannot be confirmed.

This message is displayed if slope is out of the accepted range.

Slope under accepted value (30 % default slope).

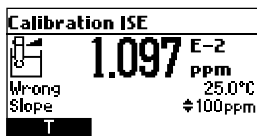

Slope over accepted value (130 % default slope).

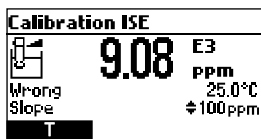

Wrong old slope

An inconsistency between new and previous (old) calibration is detected. Clear old calibration parameters and proceed calibration from the current point. The instrument will keep all confirmed values during current calibration.

The instrument will display "----" on the primary LCD if is not calibrated or after all calibrations are cleared.

If "Clear" is pressed during the first calibration point, the instrument returns to measurement mode.

Notes: Press T functional key or MODE to select temperature value to be changed if the temperature probe is not connected.

ISE range is not temperature compensated.

GLP is a set of functions that allows storage and retrieval of data regarding the maintenance and status of the electrode.

All data regarding pH, Rel mV or ISE calibration is stored for the user to review when necessary.

EXPIRED CALIBRATION

The instrument is provided with a real time clock (RTC), in order to monitor the time elapsed since the last pH calibration.

The real time clock is reset every time the instrument is calibrated and the “Expired Calibration” status is triggered when the instrument detects a calibration time out. The “CAL DUE” tags will start blinking to warn the user that the instrument should be recalibrated.

The calibration time out can be set (see **SETUP** for details, page 31) from 1 to 7 days or can be disabled.

For example, if a 4 days time out has been selected, the instrument will issue the alarm exactly 4 days after the last calibration.

However, if at any moment the expiration value is changed (e.g. to 5 days), then the alarm will be immediately recalculated and appear 5 days after the last calibration.

Notes: When the instrument is not calibrated or calibration is cleared (default values loaded) there is no “Expired Calibration”, and the display always shows the “CAL DUE” tags blinking.

When an abnormal condition in the RTC is detected, the instrument forces the “Expired Calibration” status.

LAST pH CALIBRATION DATA

The last pH calibration data is stored automatically after a successful calibration.

To view the pH calibration data, press **GLP** when the instrument is in the pH measurement mode.

Last pH cal	Buffer[pH]
Date: 2006/02/02	8.00*
Time: 16:08:25	4.01
Cal Expire: Disabled	7.01
Offset: -1.4mV	
Average Slope: 99.3%	

The instrument will display a lot of data including calibration buffer, offset, slope, electrode condition.

Note: Buffers displayed in video inverse mode are from previous calibrations. The custom buffers are marked with an “” on the right side of the buffer value. “No user calibration” message is displayed if all calibration are cleared or the instrument was not calibrated in the pH range.*

LAST RELATIVE mV CALIBRATION DATA

Last Relative mV calibration data is stored automatically after a successful calibration.

To view the Relative mV calibration data, press **GLP** key while in Relative mV measurement mode.

The instrument will display the Relative mV GLP information: calibration date, time and offset.

Last Rel mV cal	
Date:	2006/01/17
Time:	08:34:14
Offset:	-28.6mV

LAST ISE CALIBRATION DATA

Last ISE calibration data is stored automatically after a successful calibration.

To view the ISE calibration data, press **GLP** while in ISE measurement mode.

The instrument will display the ISE calibration information: calibration date, time, slope, calibration status and electrode type.

Last ISE cal		Standard[User]
Date:	2006/01/17	10.0
Time:	08:38:32	1.00
Cal Expire:	Disabled	
Slope:	96.2%	
ISE:	Ammonia	

*Notes: Press **GLP** or **ESC** at any moment and the instrument will return to measurement mode.*

If calibration has not been performed, the instrument displays "No user calibration" message.

The calibration standards from previous calibration are displayed in video inverse mode.

Setup mode allows viewing and modifying the measurement parameters. These are general **SETUP** parameters for all the ranges and range specific parameters. The following table lists the general **SETUP** parameters, their valid range and the factory default settings.

	Description	Valid value	Default
Backlight	Backlight level	0 to 7	4
Contrast	Contrast level	0 to 20	10
Auto light off	Time until backlight is ON	1, 5, 10, 30 min	1
Auto power off	Time after the instrument is powered OFF	Disabled 5, 10, 30, 60 min	30
Date/Time		01.01.2006 to 12.31.2099 00:00 to 23:59	current date/time
Time Format		AM/PM or 24 hours	24 hours
Date Format		DD/MM/YYYY MM/DD/YYYY YYYY/MM/DD YYYY-MM-DD Mon DD, YYYY DD-Mon-YYYY YYYY-Mon-DD	YYYY/MM/DD
Language	Message display language	Up to four languages	English
Temperature unit		°C or °F	°C
Beep ON	Beeper Status	Enabled or Disabled	Disabled
Instrument ID	Instrument Identification	0000 to 9999	0000
Baud RAte	Serial Communication	600, 1200, 2400, 4800, 9600	9600
Meter information	Displays general information		

The following table lists the specific range parameters.

Item	Description	Valid value	Default
Calibration Timeout (pH & ISE)	Number of days after Calibration warning is displayed	Disable, 1 to 7 days	Disable
First point mode (pH)	Management of 1 point calibration	Replace or offset	Replace
Custom buffer (pH)	Custom buffer setting	Max. 5 buffers	No
View calibration points (pH)	Display calibration points	Enable or disabled	Enable
Display out of Cal. Range Warning		Enable or disabled	Enable
ISE probe (HI98191 only)	Type of ISE probe	Custom or Standard (17)	Fluoride
ISE unit (HI98191 only)		User, ppt, g/L, ppm, mg/L, ppb, $\mu\text{g/L}$, mg/mL, M, mol/L, mmol/L, % W/V	ppm

GENERAL PARAMETER SCREENS

Backlight

Highlight *Backlight*.

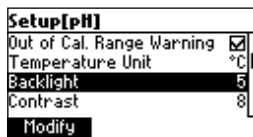

Press **Modify**.

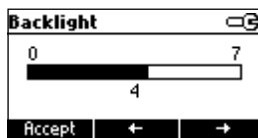

Use ← / → keys to change the intensity then press **Accept** to confirm.
Press **ESC** to leave without changing.

Contrast

Highlight *Contrast*.

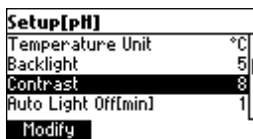

Press **Modify**.

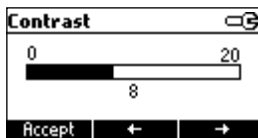

Use ← / → keys to change contrast then press **Accept** to confirm.
Press **ESC** to leave without changing.

Auto Light Off

Highlight *Auto Light Off*.

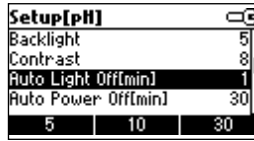

Press 5, 10 or 30 to change settings.

Auto Power Off

Highlight *Auto Power Off*.

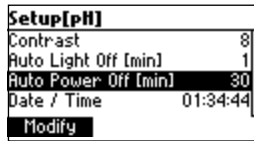

Press **Modify**.

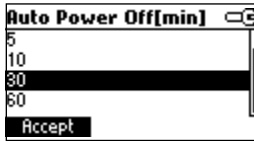

Press ▲/▼ keys to select interval then press **Accept**.

Press **ESC** to leave without changing.

Date/Time

Highlight *Date/Time*.

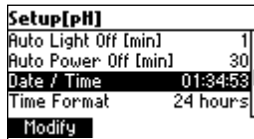

Press **Modify**.

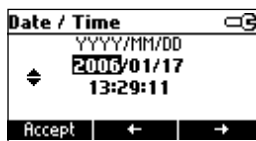

Use ←/→ keys to select item.

Use ▲/▼ keys to change focused values.

Press **Accept** to confirm new setting, or **ESC** to leave without changing.

Time Format

Highlight *Time Format*.

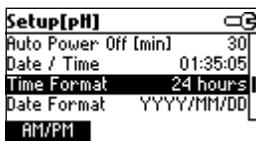

Press displayed functional key to change the option.

Date Format

Highlight *Date Format*.

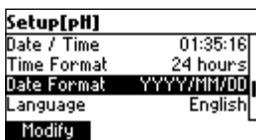

Press **Modify**.

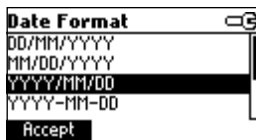

Use ▲/▼ keys to select date format then press **Accept**.

Press **ESC** to leave without changing.

Language

Highlight *Language*.



Use the desired functional key to change the option. Wait until new language is loaded. If language load fails the instrument will try to reload current language.

If any language can't be loaded, the instrument will work in safe mode. In this mode all messages are displayed in English and **Help** is not available.

Temperature Unit

Highlight *Temperature Unit*.

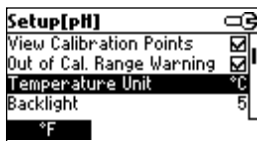

Press the displayed functional key in order to change the temperature unit.

Beep On

Highlight *Beep On*.

Press the displayed functional key to enable/disable beep.

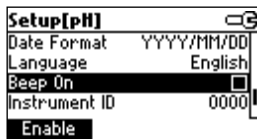

When enabled, beep sounds as a short beep every time a key is pressed or when the calibration can be confirmed.

A long beep alert that the pressed key is not active or a wrong condition is detected while in calibration.

Instrument ID

Highlight *Instrument ID*.

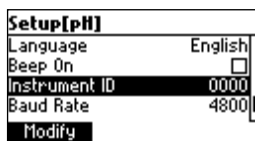

Press **Modify**.

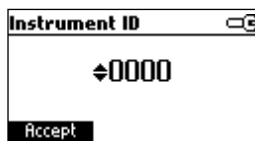

Use ▲/▼ keys to change the instrument ID.
Press **Accept** to confirm or **ESC** to exit without saving.

Baud Rate

Highlight *Baud Rate*.

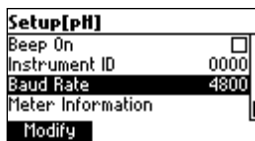

Press **Modify**.

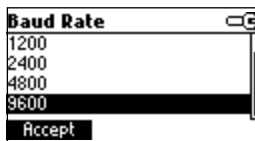

Use ▲/▼ keys to select the desired communication baud.
Press **Accept** to confirm or **ESC** to exit.

Meter information

Highlight *Meter Information*.

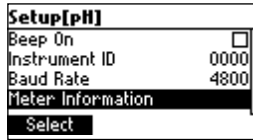

Press **Select**.

The meter informations are displayed:

- firmware version
- language version
- mV and temperature factory calibration time/date
- battery capacity

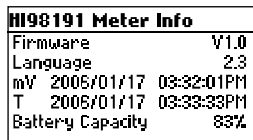

RANGE SPECIFIC PARAMETERS SCREENS

Calibration Timeout

Highlight *Calibration Timeout*.

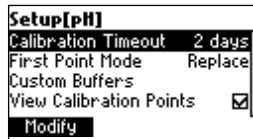

Press **Modify**.

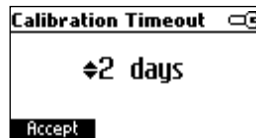
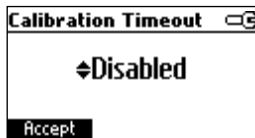

Use **▲/▼** keys to set desired value.

Press **Accept** to confirm or **ESC** to return without saving.

Note: If enabled “CAL DUE” warning will be displayed, the set number of days after calibration is over passed.

First Point Mode

Highlight *First Point Mode*.

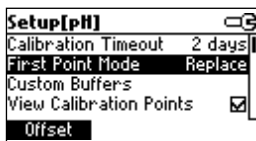

Press the displayed functional key in order to change the option.

First point mode refers to the behavior of the instrument regarding “One point calibration”.

If **Offset** is set, after one point calibration the instrument evaluate the offset and keep unchanged the slopes.

Custom Buffers

Highlight *Custom Buffers*.

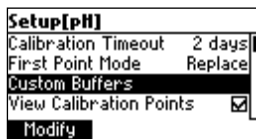

Press **Modify**.

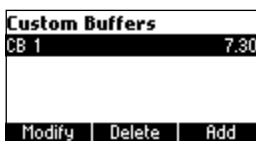

Press **Delete** to delete focused buffer.

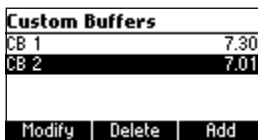

Press **Add** to add a new buffer to the list (max 5).

Press **Modify** to set custom buffer value.

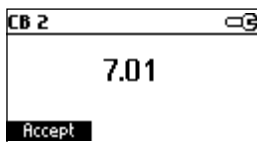

Use **▲/▼** keys to change the value.

Press **Accept** to confirm custom buffer value or **ESC** to exit without saving.

View Calibration Points

Highlight *View Calibration Points*.

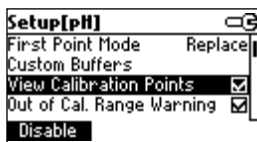

Press the displayed functional key to change option.

If option is enabled the calibration buffers corresponding to the last calibration are displayed in the pH measurement screen.

Out of Calibration Range Warning

Highlight *Out of Cal. Range Warning*.

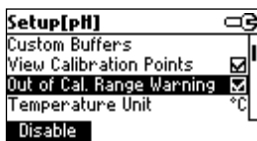

Press the displayed functional key in order to change option.

If enabled, the **"Out Cal Range"** message will be displayed if the pH reading is not within the calibration range.

ISE probe

Highlight *ISE probe*.

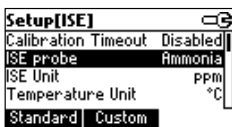

Press **Custom** in order to set the parameters for a custom probe.

Press **Standard** in order to select one probe from the standard probes list.

If **Custom** is pressed:

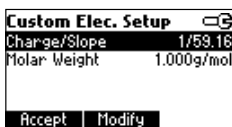

Use $\blacktriangle/\blacktriangledown$ keys to highlight the parameter to be changed (“Change Slope” or “Molar Weight”).

Highlight *Change Slope*.

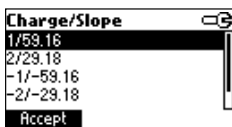

Use $\blacktriangle/\blacktriangledown$ keys in order to select the desired combination.

If **None/-59.16** is selected the slope of the probe can be changed by pressing **Modify** key.



Press **Modify**.

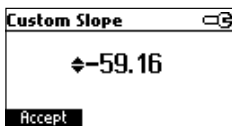

Use $\blacktriangle/\blacktriangledown$ keys to change the slope.

Press **Accept** to confirm or **ESC** to exit.

Highlight *Molar Weight*.

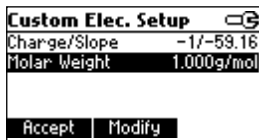

Press **Modify** in order to change molar weight.

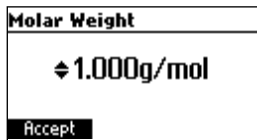

Use ▲/▼ keys to change the value. Press **Accept** to confirm or **ESC** to exit.
If **Standard** was pressed.



Use ▲/▼ keys to highlight the desired electrode.
Press **Accept** to confirm setting or **ESC** to exit.
Press **View** to see probe parameters.

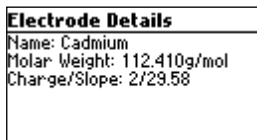

ISE Unit

Highlight *ISE Unit*.

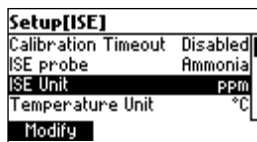

Press **Modify**.

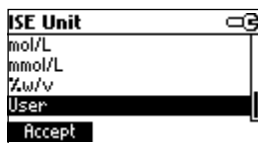

Use ▲/▼ key to select unit.

Press **Accept** to confirm selection or **ESC** to exit.

Note: If the unit is changed or "User" is selected a warning message will be displayed to alert that the ISE range must be calibrated.

If a new probe was selected or custom probe parameter are changed, the ISE range must be calibrated.

This feature allows the user to log pH, Rel mV or ISE measurements. All logged data can be transferred to a PC through the **USB** port using **HI92000** application.

The maximum logging space is 300 for **HI98191** and 200 for **HI98190** record locations (100 records on each range).

LOGGING THE CURRENT DATA

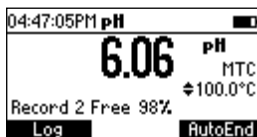

To store the current reading into memory, press **LOG** while in measurement mode.

The instrument will display for few seconds the record number and the amount of the free log space.

If the LOG space is full, the “**Log space is full**” message will be displayed for few seconds when

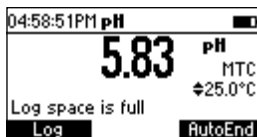

Log key is invoked. Enter View Logged Data Mode and delete records in order to free log space.

VIEW LOGGED DATA

Press **RCL** to retrieve the information stored while in measurement mode for the specific range.

	pH	Date
1	6.06	2006/01/18
2	6.06	2006/01/18
3	6.06	2006/01/18
4	6.06	2006/01/18

Delete All Delete More

The list of records is displayed.

If no data were logged, the instrument will display “**No Records**” message.

Use **▲/▼** keys to scroll between the records from the list.

Press **Delete All** to enter Delete All screen.

Press **Delete** to enter Delete records screen.

Press **More** to view more information of the focused record.

If **More** is pressed.

Record number: 3
Log time: 04:48:04PM
Temperature: 100.0°C
mV: 58.7
Offset: -10.5mV
Slope: 98.0 %

Use **▲/▼** keys to scroll between complete log information.

If **Delete** is pressed.

Delete Record?		
1	6.06	2006/01/18
2	6.06	2006/01/18
3	6.06	2006/01/18
4	6.06	2006/01/18
CFM		

Use **▲/▼** key to focus the record to be deleted and then press **CFM**.

Press **ESC** to exit.

If **Delete All** is pressed the instrument asks for confirmation.

Press **CFM** to confirm or **ESC** to exit without deleting.

To freeze the first stable reading on the LCD press **AutoEnd** while the instrument is in measurement mode.

05:10:48PM	Rel mV	Wait	☒
86.8		Rel	
58.2 Abs mV		mV	
		↕25.0°C	
Log		Continue	

The **"Wait"** symbol will blink until the reading is stable.

When the reading is stable, **"Hold"** icon will be displayed.

05:12:00PM	Rel mV	Hold	☒
86.7		Rel	
58.1 Abs mV		mV	
		↕25.0°C	
Log		Continue	

Press **Continue** in order to enter continuous reading mode.

All the instruments are factory calibrated for mV and temperature.

Hanna Instruments's temperature probes are interchangeable and no temperature calibration is needed when they are replaced.

If the temperature or ORP measurements are inaccurate, calibration should be performed.

For an accurate recalibration, contact your local Hanna Instruments Office or follow the instructions below.

ENTER CALIBRATION MODE

With the instrument off, press and hold down the ▲/▼ then power on the instrument. The calibration screen is displayed. Press "T" functional key to enter the temperature calibration mode.

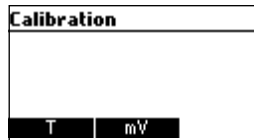

TEMPERATURE CALIBRATION

- Prepare a vessel containing ice and water and another one containing hot water (at approximately 50 °C or 122 °F). Place insulation material around the vessels to minimize temperature changes.
- Use a calibrated thermometer with a resolution of 0.1 °C as a reference thermometer. Connect the temperature probe to the appropriate socket.

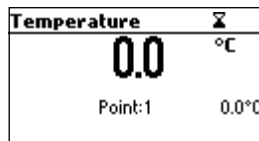

- Immerse the temperature probe or the pH probe including temperature sensor into the vessel with ice and water as close as possible to the reference thermometer. Allow a few seconds for the probe to stabilize.
- Use the ▲/▼ keys to set the calibration point value to that of ice and water mixture, measured by the reference thermometer. When the reading is stable and within range of the selected calibration point, the CFM functional key is displayed.

- Press **CFM** to confirm.
- The second expected calibrated point is displayed.

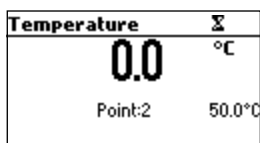

- Immerse the temperature probe into the second vessel as close as possible to the reference thermometer. Allow a few seconds for the probe to stabilize.

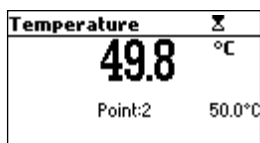

- Use the ▲/▼ keys to set the calibration point value to that of the hot water.
- When the reading is stable and within range of the selected calibration point, **CFM** functional key is displayed.

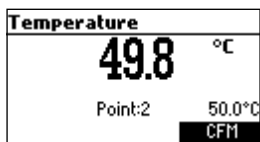

- Press **CFM** to confirm. The instrument returns to measurement mode.

Note: Use ▲/▼ keys to change calibration point if necessary (± 10.0 °C) around the point. If the reading is not within range of the selected calibration point, "Wrong" message will blink. Change the temperature probe and restart calibration.

mV CALIBRATION

A two point calibration can be performed at 0 mV and 1800 mV.

- Attach to the BNC connector a mV simulator with an accuracy of ± 0.1 mV.
- Enter the calibration screen. Press **mV** functional key.
- Set **0.0 mV** on the simulator.
- When the reading is stable and within range of the selected calibration point, the **CFM** functional key is displayed.
- Press **CFM** to confirm. The second calibration point of 1800 mV will be displayed.

- Set **1800.0 mV** on the simulator.
- When the reading is stable and within range of the selected calibration point, the **CFM** functional key is displayed.
- Press **CFM** to confirm. The instrument returns to calibration screen.
- Press **ESC** to return to measurement mode.

Notes: If the reading is not within range of the selected calibration point, "WRONG" tag will blink. Verify calibration condition or contact your local Hanna Instruments Office if you cannot calibrate.

Press CAL or ESC in any moment of the calibration process. The instrument will return in the measurement mode.

Data transmission from the instrument to the PC can be done with the **HI92000** Windows® compatible software (optional). **HI92000** also offers graphing and on-line help feature.

Data can be exported to the most popular spreadsheet programs for further analysis.

To allow our users access to the latest version of Hanna Instruments PC compatible software, we made the products available for download at <http://software.hannainst.com>. Select the product code and click **Download Now**. After download is complete, use the **setup.exe** file to install the software. To connect your instrument to a PC, use an **USB** cable connector. Make sure that your instrument is switched off and plug one connector to the instrument **USB** socket and the other to the serial or USB port of your PC.

*Note: If you are not using Hanna Instruments **HI92000** software, please see the following instructions.*

SENDING COMMANDS FROM PC

It is also possible to remotely control the instrument with any terminal program. Use an USB cable to connect the instrument to a PC, start the terminal program and set the communication options as follows: 8, N, 1, no flow control.

COMMAND TYPES

To send a command to the instrument follow the next scheme:

<command prefix> <command> <CR>

where: <command prefix> is the 16 ASCII character

<command> is the command code.

Note: Either small or capital letters can be used.

SIMPLE COMMANDS

KF1	Is equivalent to pressing functional key 1
KF2	Is equivalent to pressing functional key 2
KF3	Is equivalent to pressing functional key 3
RNG	Is equivalent to pressing RANGE key
MOD	Is equivalent to pressing MODE key
CAL	Is equivalent to pressing CAL key
UPC	Is equivalent to pressing the UP arrow key
DWC	Is equivalent to pressing the DOWN arrow key
RCL	Is equivalent to pressing RCL key
SET	Is equivalent to pressing SETUP key
CLR	Is equivalent to pressing CLR key

- OFF** Is equivalent to pressing **OFF** key
- CHR xx** Change the instrument range according with the parameter value (xx):
- xx=00 pH range/0.001 resolution
 - xx=01 pH range/0.01 resolution
 - xx=02 pH range/0.1 resolution
 - xx=03 mV range
 - xx=04 Relative mV range
 - xx=05 ISE range ([HI98191](#))

The instrument will answer for these commands with:

<STX> <answer> <ETX>

where:

<STX> is 02 ASCII code character (start of text)

<ETX> is 03 ASCII code character (end of text)

<answer>:

<ACK> is 06 ASCII code character (recognized command)

<NAK> is 21 ASCII code character (unrecognized command)

<CAN> is 24 ASCII code character (corrupted command)

COMMANDS REQUIRING AN ANSWER

The instrument will answer for these commands with:

<STX> <answer> <checksum> <ETX>

where the checksum is the bytes sum of the answer string sent as 2 ASCII characters.

All the answer messages are with ASCII characters.

- RAS** Causes the instrument to send a complete set of readings in according with the current range:

- pH, temperature and mV reading on pH range.
- Rel mV, absolute mV and temperature reading on Rel mV range.
- concentration, mV and temperature reading on ppm range ([HI98191](#)).

The answer string contains:

- Meter mode (2 chars):
- 00 - pH range (0.001 resolution)
- 01 - pH range (0.01 resolution)
- 02 - pH range (0.1 resolution)
- 03 - mV range
- 04 - Rel mV range
- 05 - ISE range

- Meter status (2 chars of status byte): represents a 8 bit hexadecimal encoding.
- 0x10 - temperature probe is connected
- 0x01 - new GLP data available
- 0x02 - new SETUP parameter
- 0x04 - out of calibration range
- 0x08 - the meter is in autoend point mode
- Reading status (2 chars): R - in range, O - over range, U - under range. First character corresponds to the primary reading. Second character corresponds to mV reading.
- Primary reading (corresponding to the selected range) - 11 ASCII chars, including sign and decimal point and exponent.
- Secondary reading (only when primary reading is not mV) - 7 ASCII chars, including sign and decimal point.
- Temperature reading - 7 ASCII chars, with sign and two decimal points, always in °C.

MDR GLP

Requests the instrument model name and firmware code (16 ASCII chars).

Requests the calibration data record.

The answer string contains:

- GLP status (1 char): represents a 4 bit hexadecimal encoding.
 - 0x01 - pH calibration available
 - 0x02 - Rel mV calibration available
 - 0x04 - ISE calibration available
- pH calibration data (if available), which contains:
 - the number of calibrated buffers (1 char)
 - the ion charge, with sign (2 chars)
 - the offset, with sign and decimal point (7 chars)
 - the average of slopes, with sign and decimal point (7 chars)
 - the calibration time, **yymmddhhmmss** (12 chars)
 - buffers information (for each buffer)
 - type (1 char): 0 - standard, 1 - custom
 - status (1 char): N (new) - calibrated in last calibration; O (old) - from an old calibration.
 - warnings during calibration (2 chars): 00 - no warning, 04 - Clean Electrode warning.
 - buffer value, with sign and decimal point and exponent (11 chars).
 - calibration time, **yymmddhhmmss** (12 chars).

- electrode condition, with sign (3 chars). The “-01” code means not calculated.
- Rel mV calibration data (if available), which contains:
 - the calibration offset, with sign (7 chars)
 - the calibration time, **yymmddhhmmss** (12 chars).
- ISE calibration data (if available), which contains:
 - the number of calibrated standards (1 char)
 - the ion charge, with sign (2 chars)
 - the calibration slope, with sign and decimal point (7 chars)
 - the calibration time, **yymmddhhmmss** (12 chars)
 - standards information (for each standard)
 - type (1 char): 0 - always standard solution.
 - status (1 char): N (new) - calibrated in last calibration;
0 (old) - from an old calibration.
 - warnings during calibration (2 chars): 00 - no warning.
 - standard value, with sign and decimal point and exponent (11 chars).
 - calibration time, **yymmddhhmmss** (12 chars).

PAR Requests the setup parameters setting.

The answer string contains:

- Instrument ID (4 chars)
- Calibration Alarm time out for pH (2 chars)
- Calibration Alarm timeout for ISE (2 chars) - if ISE available
- SETUP information (2 chars): 8 bit hexadecimal encoding.
 - 0x01 - beep ON (else OFF)
 - 0x04 - degrees Celsius (else degrees Fahrenheit)
 - 0x08 - Offset calibration (else Point calibration)
- Auto Light Off time (3 chars)
- Auto Power Off time (3 chars)
- The number of custom buffers (1 char)
- The custom buffer values, with sign and decimal point, for each defined custom buffer (7 chars)
- The ID of the ISE electrode (2 chars) - if ISE available
- The molar weight of the selected ION, with sign and decimal point (9 ASCII characters)
- The ion charge (2 chars)
- The ISE unit (2 chars)

- The short name of the selected language (3 chars)
- NSLx** Requests the number of logged samples (4 chars).
The command parameter (1 char):
- P - request for pH range
 - M - request for mV and Rel mV ranges
 - I - request for ISE range
- LODPxxx** Requests the xxxth pH record logged data.
- LODMxxx** Requests the xxxth mV/Rel mV record logged data.
- LODIxxx** Requests the xxxth ISE record logged data (HI98191).
- LODPALL** Requests all pH Log on demand.
- LODMALL** Requests all mV/Rel mV Log on demand.
- LODIALL** Requests all ISE Log on demand (HI98191).

The answer string for each record contains:

- The logged mode (2 chars):
 - 00 - pH range (0.001 resolution)
 - 01 - pH range (0.01 resolution)
 - 02 - pH range (0.1 resolution)
 - 03 - mV range
 - 04 - Rel mV range
 - 05 - ISE range
- Reading status (1 char): R, O, U
- Calculated reading, with sign and decimal point and exponent (11 chars) - for pH, Rel mV and ISE range
- Temperature reading, with sign and two decimal points (7 chars)
- mV reading status (1 char): R, O, U
- The mV reading, with sign and decimal point (7 chars)
- The logged time, **yymmddhhmmss** (12 chars)
- The calibration slope, with sign and decimal point (7 chars) - not available for Rel mV range
- The calibration offset, with sign and decimal point (7 chars) - not available for ISE
- Temperature probe presence (1 char)

Notes: "Err8" is sent if the instrument is not in measurement mode.

"Err6" is sent if the requested range is not available.

"Err4" is sent if the requested set parameter is not available.

"Err3" is sent if the Log on demand is empty.

"Err9" is sent if the battery power is less than 30%.

Invalid commands will be ignored.

To replace the batteries, follow the next steps:

- Turn OFF the instrument.
- Open the battery compartment by removing the four screws from the back of the instrument.
- Remove the old batteries.
- Insert four new 1.5V AA batteries in the battery compartment while paying attention to the correct polarity.
- Close the battery compartment using the four screws.

If the battery capacity is less than 20 % the serial communication and the backlight feature are not available.

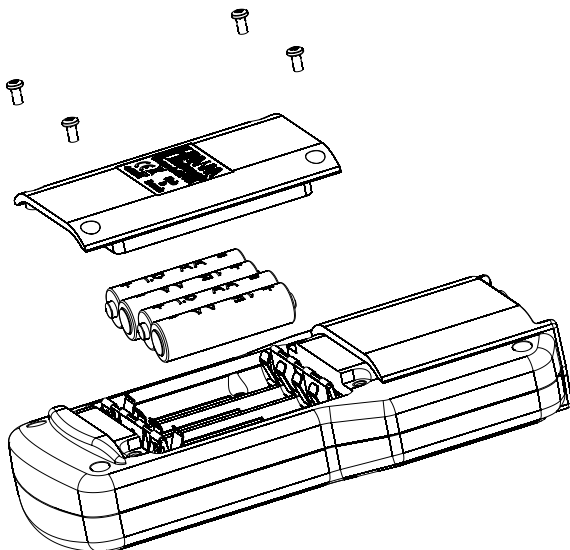

Note: The instrument is provided with the BEPS (Battery Error Prevention System) feature, which automatically turns the instrument off when the batteries level is too low to ensure reliable readings.

The resistance of glass electrodes partially depends on the temperature. The lower the temperature, the higher the resistance. It takes more time for the reading to stabilize if the resistance is higher. In addition, the response time will suffer to a greater degree at temperatures below 25 °C (77 °F).

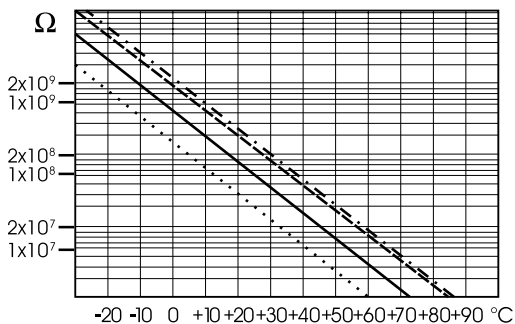

Since the resistance of the pH electrode is in the range of 50 – 200 MΩ, the current across the membrane is in the pico Ampere range. Large currents can disturb the calibration of the electrode for many hours.

For these reasons high humidity environments, short circuits and static discharges are detrimental to a stable pH reading.

The pH electrode’s life also depends on the temperature. If constantly used at high temperatures, the electrode life is drastically reduced.

Typical Electrode Life

- Ambient Temperature 1 – 3 years
- 90 °C (194 °F) Less than 4 months
- 120 °C (248 °F) Less than 1 month

Alkaline Error

High concentrations of sodium ions interfere with readings in alkaline solutions. The pH at which the interference starts to be significant depends upon the composition of the glass. This interference is called alkaline error and causes the pH to be underestimated. Hanna Instruments’s glass formulations have the indicated characteristics.

Sodium Ion Correction for the Glass at 20-25 °C (68-77 °F)		
Concentration	pH	Error
0.1 Mol L ⁻¹ Na ⁺	13.00	0.10
	13.50	0.14
	14.00	0.20
1.0 Mol L ⁻¹ Na ⁺	12.50	0.10
	13.00	0.18
	14.00	0.40

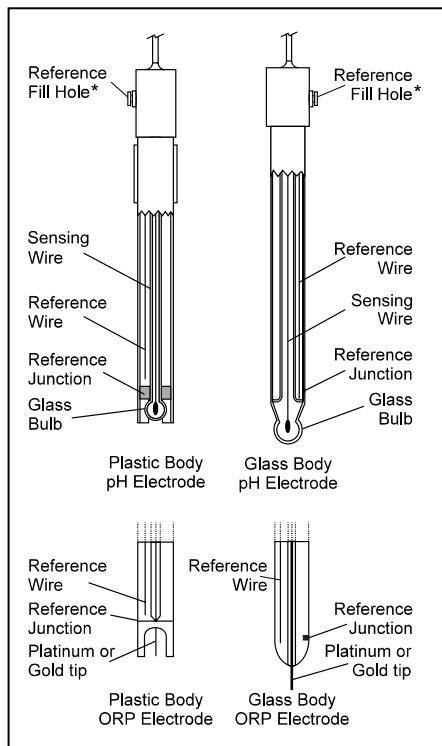

*Not present in gel electrodes.

PREPARATION PROCEDURE

Remove the electrode protective cap.

DO NOT BE ALARMED IF ANY SALT DEPOSITS ARE PRESENT. This is normal with electrodes and they will disappear when rinsed with water.

During transport tiny bubbles of air may have formed inside the glass bulb. The electrode cannot function properly under these conditions. These bubbles can be removed by "shaking down" the electrode as you would do with a glass thermometer.

If the bulb and/or junction are dry, soak the electrode in [HI70300](#) Storage Solution for at least one hour.

For refillable electrodes:

If the filling solution (electrolyte) is more than 2 1/2 cm (1") below the fill hole, add [HI7082](#) or [HI8082](#) 3.5M KCl Electrolyte Solution for double junction or [HI7071](#) or [HI8071](#) 3.5M KCl+AgCl Electrolyte Solution for single junction electrodes.

For faster response, unscrew the fill hole screw during measurements.

For AmpHel® electrodes:

If the electrode does not respond to pH changes, the battery run down and the electrode should be replaced.

MEASUREMENT

Rinse the pH electrode tip with distilled water. Immerse the tip (bottom 4 cm /1½" ensuring the reference junction is submerged) in the sample and stir gently for a few seconds.

For a faster response and to avoid cross-contamination of the samples, rinse the electrode tip with a few drops of the solution to be tested, before taking measurements.

See that the sleeve holes of the ORP probe are completely submerged.

STORAGE PROCEDURE

To minimize clogging and assure a quick response time, the glass bulb and the junction of pH electrode should be kept moist and not allowed to dry out.

Replace the solution in the protective cap with a few drops of [HI70300](#) or [HI80300](#) Storage Solution or, in its absence, Filling Solution ([HI7071](#) or [HI8071](#) for single junction and [HI7082](#) or [HI8082](#) for double junction electrodes). Follow the Preparation Procedure on page 56 before taking measurements.

Note: NEVER STORE THE ELECTRODE IN DISTILLED OR DEIONIZED WATER.

PERIODIC MAINTENANCE

Inspect the electrode and the cable. The cable used for connection to the instrument must be intact and there must be no points of broken insulation on the cable or cracks on the electrode stem or bulb. Connectors must be perfectly clean and dry. If any scratches or cracks are present, replace the electrode.

Rinse off any salt deposits with water.

pH Probe Maintenance

For refillable electrodes:

Refill the reference chamber with fresh electrolyte ([HI7071](#) or [HI8071](#) for single junction or [HI7082](#) or [HI8082](#) for double junction electrodes). Allow the electrode to stand upright for 1 hour.

Follow the Storage Procedure above.

pH CLEANING PROCEDURE

- General Soak in Hanna Instruments [HI7061](#) or [HI8061](#) General Cleaning Solution for approximately ½ hour.
- Protein Soak in Hanna Instruments [HI7073](#) or [HI8073](#) Protein Cleaning Solution for 15 minutes.
- Inorganic Soak in Hanna Instruments [HI7074](#) Inorganic Cleaning Solution for 15 minutes.
- Oil/grease Rinse with Hanna Instruments [HI7077](#) or [HI8077](#) Oil and Fat Cleaning Solution.

IMPORTANT: After performing any of the cleaning procedures, rinse the electrode thoroughly with distilled water, refill the reference chamber with fresh electrolyte (not necessary for gel-filled electrodes) and soak the electrode in **HI70300** or **HI80300** Storage Solution for at least 1 hour before taking measurements.

SYMPTOMS	PROBLEM	SOLUTION
Slow response/excessive drift.	Dirty pH electrode.	Soak the electrode tip in HI7061 solution for 30 minutes and then follow the Cleaning Procedure.
Reading fluctuates up and down (noise).	Clogged/dirty junction. Low electrolyte level (refillable electrodes only).	Clean the electrode. Refill with fresh electrolyte (refillable electrodes only).
Display shows blinking full scale value.	Reading out of range.	Check that sample is within measurable range
mV scale out of range.	Dry membrane or dry junction.	Soak electrode in HI70300 storage solution for at least 30 minutes.
Display shows  symbol in front of temperature reading.	Out of order or missing temperature probe.	Replace temperature probe or check the connection.
Display shows "Clean electrode" blinking.	Difference between new and previous calibration has been detected.	Clean electrode and recalibrate. If the problem remains, check the buffer solutions.
Meter does not work with temperature probe.	Broken temperature probe.	Replace temperature probe.
Meter fails to calibrate or gives faulty readings.	Broken pH electrode.	Replace electrode.
Error messages are displayed during pH calibration procedure.	Wrong or contaminated buffer, electrode dirty or broken.	Check that buffer solution is correct and fresh.
Meter shuts off.	Dead batteries; Auto-off feature is enabled: in this case, meter shuts off after selected period of non-use.	Replace batteries; Press ON/OFF .
"Errxx" message at start up.	Internal error.	Contact your local Hanna Instruments Office.
The instrument does not start when pressing ON/OFF .	Initialization error.	Press and hold down ON/OFF for about 20 seconds or disconnect and then connect the batteries.

Certification

All Hanna Instruments conform to the **CE European Directives**.

Disposal of Electrical & Electronic Equipment. The product should not be treated as household waste. Instead hand it over to the appropriate collection point for the recycling of electrical and electronic equipment which will conserve natural resources.

Disposal of waste batteries. This product contains batteries, do not dispose of them with other household waste. Hand them over to the appropriate collection point for recycling.

Ensuring proper product and battery disposal prevents potential negative consequences for the environment and human health. For more information, contact your city, your local household waste disposal service, the place of purchase or go to www.hannainst.com.



RoHS
compliant



Recommendations for Users

Before using this product, make sure it is entirely suitable for your specific application and for the environment in which it is used. Any variation introduced by the user to the supplied equipment may degrade the meters' performance. For yours and the meter's safety do not use or store the meter in hazardous environments.

Warranty

The **HI98190** and **HI98191** are warranted for two years against defects in workmanship and materials when used for their intended purpose and maintained according to instructions. Electrodes and probes are warranted for six months. This warranty is limited to repair or replacement free of charge.

Damage due to accidents, misuse, tampering or lack of prescribed maintenance is not covered.

If service is required, contact your local Hanna Instruments Office. If under warranty, report the model number, date of purchase, serial number and the nature of the problem. If the repair is not covered by the warranty, you will be notified of the charges incurred. If the instrument is to be returned to Hanna Instruments, first obtain a Returned Goods Authorization (RGA) number from the Technical Service department and then send it with shipping costs prepaid. When shipping any instrument, make sure it is properly packed for complete protection.

Hanna Instruments reserves the right to modify the design, construction or appearance of its products without advance notice.

World Headquarters

Hanna Instruments Inc.
Highland Industrial Park
584 Park East Drive
Woonsocket, RI 02895 USA
www.hannainst.com



MAN98191

Printed in ROMANIA