

# HI932

## AUTOMATIC POTENTIOMETRIC TITRATOR



**Dear  
Customer,**

Thank you for choosing a Hanna Instruments product.

This manual has been written for **HI932** Automatic Potentiometric Titrator with software version 1.10 and higher.

Please read this instruction manual carefully before using this instrument. This manual will provide you with the necessary information for the correct use of this instrument, as well as a precise idea of its versatility.

If you need additional technical information, do not hesitate to e-mail us at [tech@hannainst.com](mailto:tech@hannainst.com) or view our worldwide contact list for a Hanna Instruments representative near you at [www.hannainst.com](http://www.hannainst.com).



# INTRODUCTION

The **HI932** is an automatic potentiometric titrator with high accuracy, great flexibility and repeatability.

The titrator is designed to perform a variety of potentiometric titrations, allowing the user to obtain both good results and high-speed analysis.

The main attributes of the **HI932** titrator are:

- Small footprint, requires minimal bench space
- Casing made with strong, chemically resistant plastic
- Flexible electrode holder supports up to 3 electrodes, 4 dispensing tubes, 1 temperature sensor and removable stirrer
- Electrode holder positions electrodes in the center of beaker, allowing for smaller sample sizes
- Integrated peristaltic pump available for reagent addition
- Support for 100 titration methods and 30 autosampler sequences
- User-customizable reports
- Integrated research grade pH/mV/ISE meter
- Clearly displayed warning and error messages

This manual provides information regarding installation and functionality of the titrator and refined operation suggestions. Before using the titrator, it is recommended you become familiar with its various features and functionality.

This manual is divided into four parts:

## PART 1: QUICK START GUIDE

Helps the user quickly setup and operate **HI932** Automatic Potentiometric titrator. It covers basic connections, user interface and how to run a titration.

## PART 2: INSTRUCTION MANUAL

Provides a comprehensive description of the operating principles, user interface, general options, methods, titration mode, optimization, maintenance, autosampler etc.

## PART 3: APPLICATIONS

Contains complete instructions for commonly-used analyses. Additional methods and method packs are available, contact your local Hanna Instruments office for more details.

## PART 4: TITRATION THEORY

Outlines the principles of operation of the titrator. It covers the chemistry of titrations, titration types and result calculations.



## TABLE OF CONTENTS

### PART 1: QUICK START GUIDE

1. SAFETY MEASURES .....	1-2
2. ABBREVIATIONS .....	1-2
3. TITRATOR CONNECTIONS .....	1-3
3.1. FRONT VIEW .....	1-3
3.2. REAR VIEW .....	1-4
4. USER INTERFACE .....	1-4
4.1. KEYPAD .....	1-4
4.2. DISPLAY .....	1-5
5. LANGUAGE .....	1-5
6. CONTEXTUAL HELP .....	1-5
7. METHODS .....	1-6
7.1. STANDARD METHODS .....	1-6
7.2. USER-DEFINED METHODS .....	1-6
8. HOW TO CALIBRATE A pH ELECTRODE .....	1-6
8.1. PREPARATION .....	1-6
8.2. CALIBRATION PROCEDURE .....	1-6
9. THE FIRST TITRATION .....	1-7
9.1. REQUIRED SOLUTIONS .....	1-7
9.2. PRIMING THE BURETTE .....	1-7
9.3. METHOD SELECTION .....	1-7
9.4. SETTING METHOD PARAMETERS .....	1-8
9.5. SETTING UP TITRATION REPORT .....	1-8
9.6. PREPARING THE SAMPLE .....	1-8
9.7. PERFORMING A TITRATION .....	1-9
9.8. TITRATION SCREEN .....	1-9
9.9. TITRATION GRAPH .....	1-9
9.10. TITRATION TERMINATION .....	1-10
9.11. RESULTS .....	1-10
9.12. VIEWING THE LAST TITRATION DATA .....	1-11
9.13. PRINTING THE TITRATION REPORT .....	1-11
9.14. SAVING DATA TO USB STORAGE DEVICE .....	1-11
9.15. TITRATION REPORT .....	1-12

### PART 2: INSTRUCTION MANUAL

1. SETUP .....	2-2
1.1. UNPACKING .....	2-2
1.2. SAFETY MEASURES .....	2-3
1.3. HI932 TITRATOR TECHNICAL SPECIFICATIONS .....	2-3
1.4. HI922 AUTOSAMPLER TECHNICAL SPECIFICATIONS .....	2-5
1.5. INSTALLATION .....	2-6
2. USER INTERFACE .....	2-14
2.1. START UP .....	2-14
2.2. KEYPAD .....	2-14
2.3. DISPLAY .....	2-16
2.4. MENU NAVIGATION .....	2-17
3. GENERAL OPTIONS .....	2-19
3.1. SAVE TO USB .....	2-19
3.2. RESTORE FROM USB .....	2-20



3.3. ADMINISTRATION .....	2-21
3.4. TEMPERATURE .....	2-22
3.5. DATE & TIME SETTING .....	2-24
3.6. DISPLAY SETTINGS .....	2-25
3.7. BEEPER .....	2-25
3.8. STIRRER .....	2-26
3.9. LANGUAGE .....	2-26
3.10. TOTAL VOLUME ALERT .....	2-27
3.11. TITRANT AGE REMINDER .....	2-27
3.12. USB LINK WITH PC .....	2-28
3.13. SETUP BALANCE INTERFACE .....	2-28
3.14. PRINTER MODE .....	2-32
3.15. RESET TO DEFAULT SETTINGS .....	2-33
3.16. OPTIMIZE MEMORY SPACE .....	2-33
3.17. UPDATE SOFTWARE .....	2-34
4. TITRATION METHODS .....	2-35
4.1. SELECTING METHODS .....	2-35
4.2. STANDARD METHODS .....	2-35
4.3. USER-DEFINED METHODS .....	2-37
4.4. VIEWING / MODIFYING METHOD .....	2-38
4.5. METHOD OPTIONS .....	2-39
4.6. PRINTING .....	2-73
5. TITRATION MODE .....	2-74
5.1. RUNNING A TITRATION .....	2-74
5.2. STOPPING A TITRATION / DIRECT READING .....	2-75
6. pH MODE .....	2-76
6.1. DISPLAY .....	2-77
6.2. pH SETUP .....	2-77
6.3. pH CALIBRATION .....	2-85
6.4. LOGGING .....	2-87
7. mV MODE .....	2-88
7.1. DISPLAY .....	2-89
7.2. mV SETUP .....	2-89
7.3. RELATIVE mV CALIBRATION .....	2-92
7.4. LOGGING .....	2-92
8. ISE MODE .....	2-93
8.1. DISPLAY .....	2-94
8.2. ISE SETUP .....	2-94
8.3. ISE CALIBRATION .....	2-103
8.4. LOGGING .....	2-104
9. AUXILIARY FUNCTIONS .....	2-105
9.1. BURETTE .....	2-105
9.2. STIRRER .....	2-108
9.3. RESULTS .....	2-108
10. MAINTENANCE & PERIPHERALS .....	2-113
10.1. BURETTE MAINTENANCE .....	2-113
10.2. PERIPHERALS .....	2-116
11. AUTOSAMPLER .....	2-119
11.1. START UP .....	2-119
11.2. AUXILIARY COMMANDS .....	2-121
11.3. AUTOSAMPLER OPTIONS .....	2-125
11.4. AUTOSAMPLER SEQUENCES .....	2-130

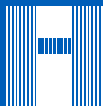

11.5. SAMPLE ANALYSIS SEQUENCE .....	2-133
11.6. pH CALIBRATION .....	2-153
11.7. ISE CALIBRATION .....	2-169
12. ACCESSORIES .....	2-187
12.1. SOLUTIONS .....	2-187
12.2. SENSORS .....	2-190
12.3. TITRATOR COMPONENTS .....	2-193
12.4. AUTOSAMPLER COMPONENTS .....	2-195

## PART 3: APPLICATIONS

HI0001EN 0.1N SODIUM HYDROXIDE TITRANT CONCENTRATION .....	3-2
HI0002EN 0.1N HYDROCHLORIC ACID TITRANT CONCENTRATION .....	3-4
HI0003EN 0.1M SODIUM THIOSULFATE TITRANT CONCENTRATION .....	3-6
HI0010EN 0.1M FERROUS AMMONIUM SULFATE TITRANT CONCENTRATION .....	3-8
HI0200EN 0.02M SILVER NITRATE TITRANT CONCENTRATION .....	3-10
HI1004EN ALKALINITY OF WATER .....	3-12
HI1005EN ACIDITY OF WATER .....	3-14
HI1007EN CHLORIDE IN WATER .....	3-16
HI1008EN NEUTRALIZATION WITH SULFURIC ACID .....	3-18
HI1009EN NEUTRALIZATION WITH SODIUM HYDROXIDE .....	3-20
HI1011EN TROUBLESHOOTING 1 .....	3-22
HI1012EN TROUBLESHOOTING 2 .....	3-24
HI1014EN CONCENTRATION OF PHOSPHORIC ACID .....	3-26

## PART 4: TITRATION THEORY

1. TITRATION THEORY .....	4-2
1.1. INTRODUCTION .....	4-2
1.2. USES OF TITRATIONS .....	4-2
1.3. ADVANTAGES & DISADVANTAGES .....	4-2
2. TYPES OF TITRATIONS .....	4-3
2.1. TITRATIONS ACCORDING TO THE MEASUREMENT METHOD .....	4-3
2.2. TITRATIONS ACCORDING TO THE REACTION TYPE .....	4-5
2.3. TITRATIONS ACCORDING TO THE TITRATION SEQUENCE .....	4-10
3. TITRATION PROCEDURE .....	4-11
3.1. MANUAL TITRATION .....	4-11
3.2. AUTOMATIC TITRATION .....	4-11
4. TITRATION RESULTS .....	4-13
4.1. ACCURACY .....	4-13
4.2. REPEATABILITY .....	4-13
4.3. SOURCES OF ERROR .....	4-13
5. CALCULATIONS .....	4-15
5.1. SAMPLE CALCULATION BY MASS .....	4-15
5.2. SAMPLE CALCULATION BY VOLUME .....	4-15
5.3. STANDARDIZE TITRANT BY MASS .....	4-15
5.4. STANDARDIZE TITRANT BY VOLUME .....	4-16
5.5. BLANK TITRATION .....	4-16
5.6. MULTIPLE ENDPOINT TITRATION .....	4-16
6. GLOSSARY .....	4-18

## PART 1:

## QUICK START GUIDE



## 1. SAFETY MEASURES

The following safety measures must be followed:

- 1) Never connect or disconnect the air pump and magnetic stirrer assembly or other peripheral with the titrator turned on.
- 2) Verify that the reagent and the attached tubing are assembled correctly.
- 3) Always check that the titrant, solvent and waste bottles, as well as the titration vessel are properly assembled.
- 4) Always wipe up spills and splashes immediately.
- 5) Avoid the following environmental working conditions:
  - Severe vibrations
  - Direct sunlight
  - Atmospheric relative humidity above 95% non-condensing
  - Environment temperatures below 10°C and above 40°C
  - Explosion hazards
  - Near heating or cooling sources
- 6) Have the titrator serviced by qualified service personnel only.
- 7) Avoid inhalation of reagent vapors. Avoid contact with chemicals.

## 2. ABBREVIATIONS

ABS	Acrylonitrile Butadiene Styrene
GLP	Good Laboratory Practice
PEI	Polyetherimide
PTFE	Polytetrafluoroethylene
PVDF	Polyvinylidene fluoride
RPM	Revolutions per minute
eq / kg	Equivalentents per kilogram
eq / L	Equivalentents per liter
g / 100 mL	Grams per 100 milliliters
g / L	Grams per liter
µg / L	Micrograms per liter
meq / kg	Milliequivalentents per kilogram
meq / L	Milliequivalentents per liter
mg / 100 mL	Milligrams per 100 milliliters
mg / g	Milligrams per gram
mg / kg	Milligrams per kilogram
mg / L	Milligrams per liter
mmol / g	Millimoles per gram
mmol / kg	Millimoles per kilogram
mmol / L	Millimoles per liter
M (mol / L)	Molarity (moles per liter)
mol / kg	Moles per kilogram
mol / L	Moles per liter
N (eq / L)	Normality (equivalentents per liter)
ppb (µg / kg)	Parts per billion (micrograms per kilogram)



ppb ( $\mu\text{g} / \text{L}$ )	Parts per billion (micrograms per liter)
ppm (mg / kg)	Parts per million (milligrams per kilogram)
ppm (mg / L)	Parts per million (milligrams per liter)
ppt (g / kg)	Parts per thousand (grams per kilogram)
ppt (g / L)	Parts per thousand (grams per liter)
% (g / 100 g)	Percent by weight (grams per 100 grams)
%w / v	Percent weight by volume

### 3. TITRATOR CONNECTIONS

#### 3.1. FRONT VIEW

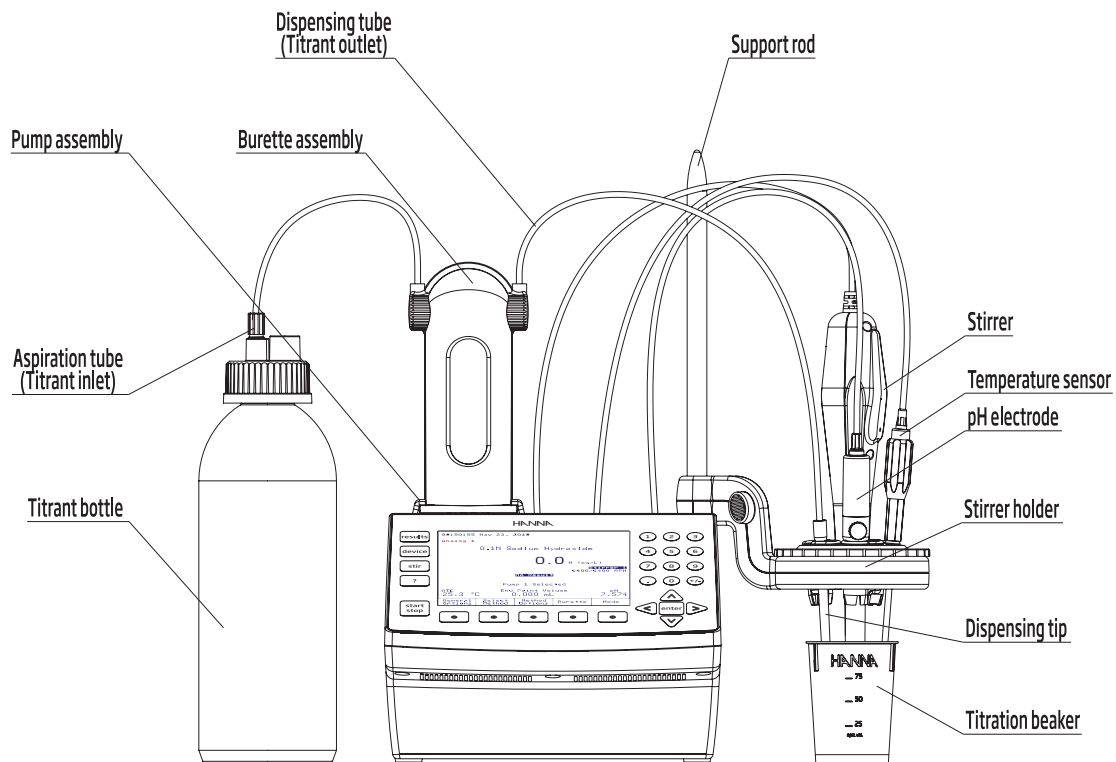

### 3.2. REAR VIEW

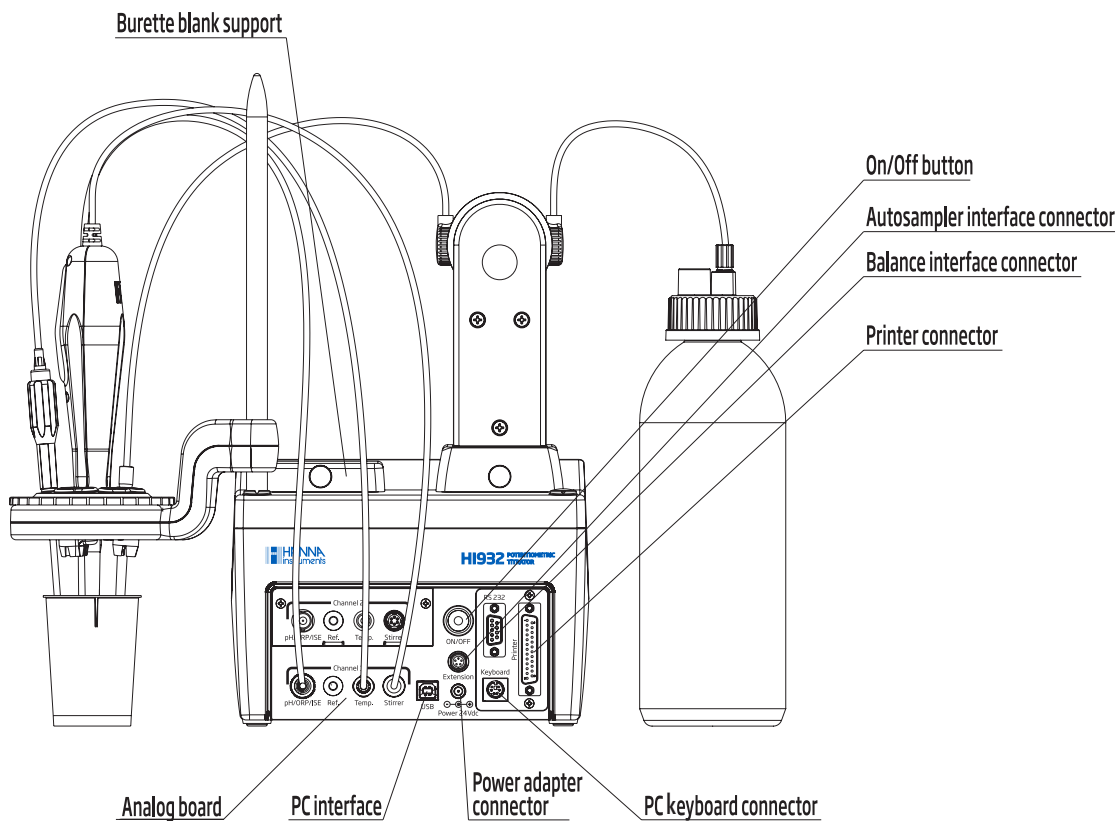

## 4. USER INTERFACE

### 4.1. KEYPAD

The titrator's keypad has 27 keys grouped in five categories, as follows:

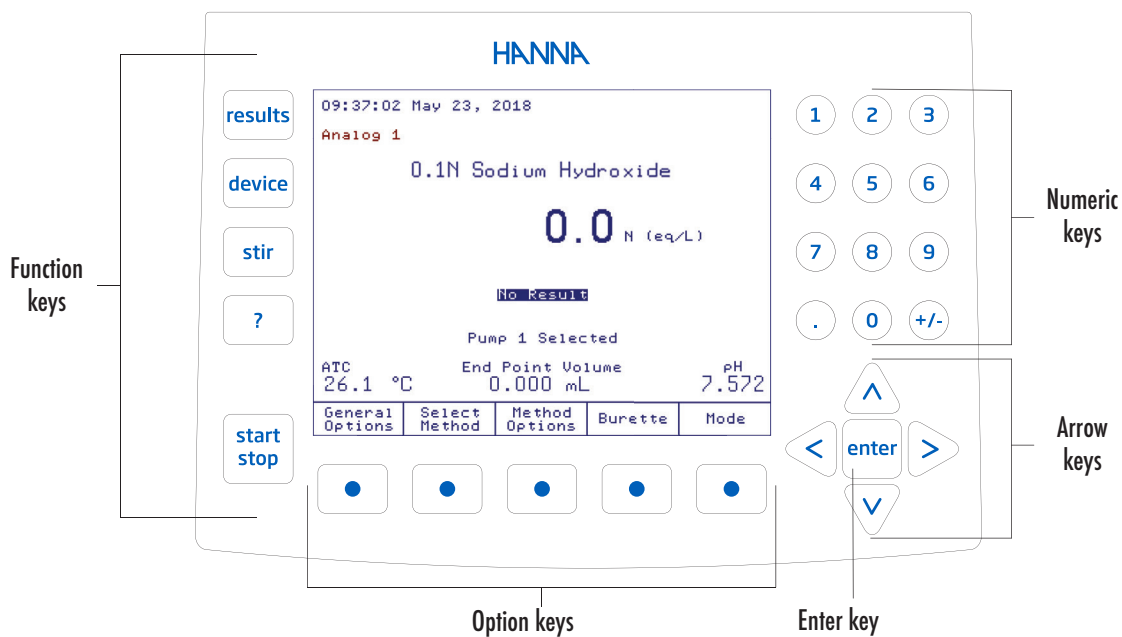

## 4.2. DISPLAY



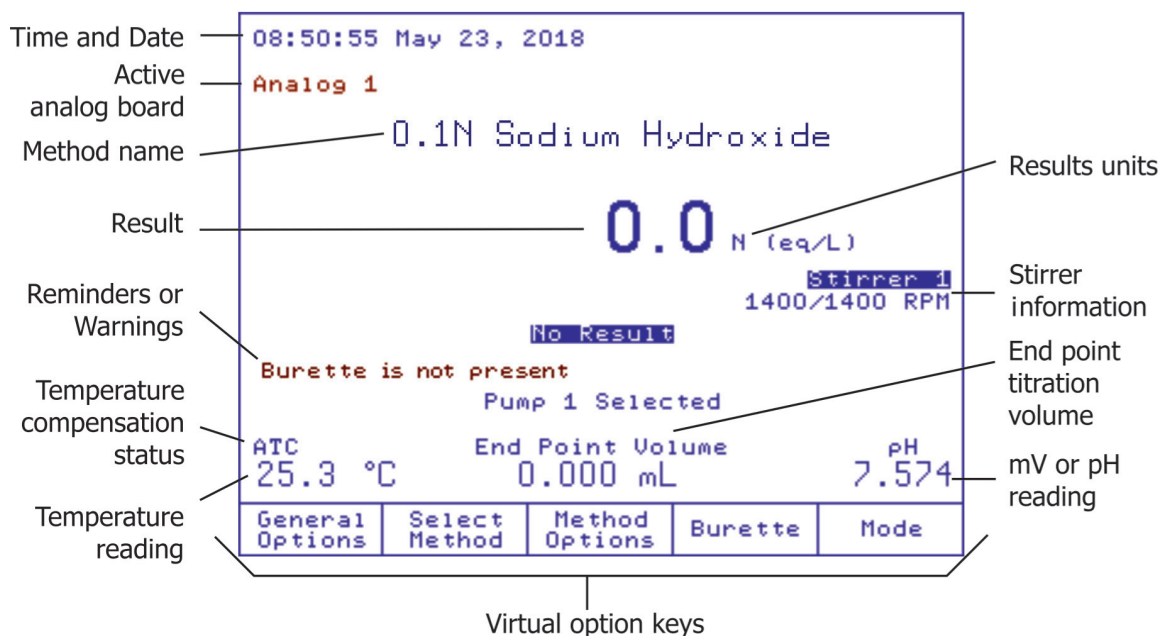

The titrator has a 5.7" graphical backlit color display.



The user interface contains several screens. In each screen, many information fields are present at the same time. The information is displayed in an easy-to-read manner.

Virtual option keys describe the function performed when the corresponding soft key is pressed.

## 5. LANGUAGE

To change the language, press  from the main screen. Highlight *Language* option. Using the  and  keys, select the language from the options listed in the **Set Language** screen and press .

Restart the titrator in order to apply the new language setting.

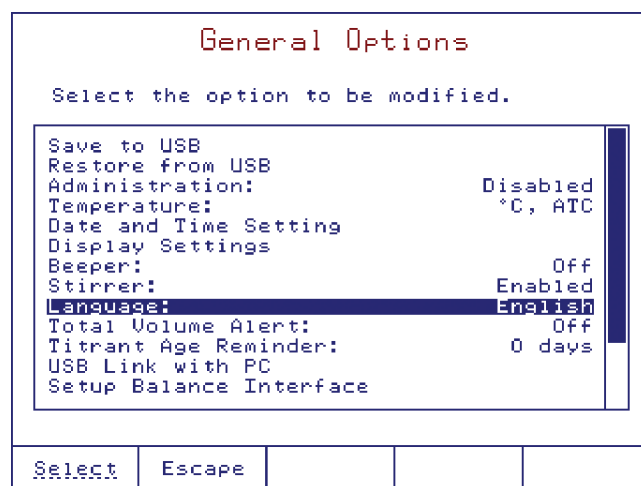

## 6. CONTEXTUAL HELP

Information about the titrator can be easily accessed by pressing . The contextual help can be accessed at any time and it provides useful information about the current screen.

## 7. METHODS

The HI932 titrator can store up to 100 methods (standard and user-defined).

### 7.1. STANDARD METHODS

Each titrator is supplied with a package of standard methods. Standard method packs are developed at Hanna Instruments to meet analysis requirements of specific industries (e.g., water treatment, wine, dairy, etc.).

### 7.2. USER-DEFINED METHODS

User defined methods allow the user to create and save their own methods. Each new method is based on an existing method which is altered to suit a specific application.

## 8. HOW TO CALIBRATE A pH ELECTRODE

To enter pH calibration mode, press  , then  , then

### 8.1. PREPARATION

Pour small quantities of the buffer solutions into clean beakers. If possible, use plastic beakers to minimize any EMC interferences.

For accurate calibration and to minimize cross-contamination, use two beakers for each buffer solution: one for rinsing the electrode and one for calibration. If you are measuring in the acidic range, use pH 7.01 or 6.86 as the first buffer and pH 4.01/3.00 or 1.68 as the second buffer. If you are measuring in the alkaline range, use pH 7.01 or 6.86 as the first buffer and pH 10.01/9.18 or 12.45 as the second buffer.

For extended range measurements (acidic and alkaline), perform a five-point calibration by selecting five buffers across the entire pH range.

### 8.2. CALIBRATION PROCEDURE

During calibration, the user has a choice of 8 standard buffers: (pH 1.68, 3.00, 4.01, 6.86, 7.01, 9.18, 10.01, 12.45) and up to 5 custom buffers.

For accurate measurements it is recommended to perform a five-point calibration. However, at least a two-point calibration is suggested. For pH titrations, the selected buffers should bracket your endpoint (e.g. if your endpoint value is at 8.5, use 7.01 or 6.86 and 9.18 or 10.01 for calibration).

To begin calibration:

- 1) Press  . If the instrument was calibrated before, previous calibration can be cleared by pressing .

**Note:** It is very important to clear calibration history when a new electrode is used.

- 2) Immerse the pH electrode and the temperature probe approximately 4 cm (1.5") into a buffer solution and stir gently.
- 3) If necessary, select the pH calibration buffer value with  or .
- 4) Once the reading has stabilized, press  to update the calibration. The calibration buffer will be added to the Calibrated Buffers section.
- 5) Rinse the pH electrode and the temperature probe, then immerse them into the next buffer solution and follow the above procedure or press  to exit the calibration.



## 9. THE FIRST TITRATION

### 9.1. REQUIRED SOLUTIONS

- Titrant - 500 mL of 0.1 M (mol/L) Sodium Hydroxide (NaOH) in a titrant bottle.
- Sample - 0.1 mol/L Hydrochloric Acid (HCl).
- Distilled or deionized water.

**Note:** Analytical grade reagents and water should be used for accurate results.

### 9.2. PRIMING THE BURETTE

- 1) Insert the aspiration tube in the titrant bottle and the dispensing tube in a waste beaker.
- 2) From the main screen press .
- 3) Highlight the *Prime Burette* option and then press .
- 4) Enter the number of burette rinses. At least 3 rinses are recommended.
- 5) Press  to start. The message "Executing..." will be displayed.

**Note:** Make sure you have continuous liquid flow inside the burette. For accurate results, the aspiration tube, the dispensing tube and the syringe must be free of air bubbles.

### 9.3. METHOD SELECTION

For this analysis we will use the **HI1009 Neutralization w/ NaOH** standard method.

To select this method:

- 1) Press  from the Idle screen.
- 2) Use the  and  keys to highlight *HI1009 Neutralization w/ NaOH* method.
- 3) Press .

## 9.4. SETTING METHOD PARAMETERS

To display the method parameters, press .

The **View/Modify Method** screen will be displayed.

Only certain parameters can be changed.

For this titration, the NaOH titrant concentration and the size of the HCl sample need to be entered.

- 1) Highlight *Titrant Conc.* option, then press . The Titrant Concentration screen will be displayed.
- 2) Enter the correct value, then press .
- 3) Highlight *Analyte Size* option, then press .
- 4) Enter the volume of the sample (e.g.: 5 mL), then press .
- 5) Press , highlight *Save Method* option and then press .

Titrant1 Conc.

Enter the titrant 1 concentration.

0.10676 M (mol/L)

Accept	Escape	Delete Digit		Exponent
--------	--------	--------------	--	----------

## 9.5. SETTING UP TITRATION REPORT

Users can select the information that is stored for each titration.

To obtain proper information at the end of the titration, perform the following operations:

- 1) From the main screen, press  and the **Data Parameters** screen will be displayed.
- 2) Highlight *Setup Titration Report* option and press .
- 3) Mark the fields to be included with the \* symbol using the  and  keys, and press  to toggle the selection.
- 4) Press  and then press  to return to the main screen.

## 9.6. PREPARING THE SAMPLE

- 1) Add 50 to 65 mL of distilled / deionized water to the titration beaker.
- 2) Use a pipette or burette to add 5.0 mL of the sample (0.1M Hydrochloric Acid (HCl)) into the same beaker.
- 3) Slide the stirrer assembly up.
- 4) Place the beaker under the stirrer assembly.
- 5) Lower the stirrer assembly until the electrodes are submersed and the stirrer is close to the bottom of the beaker.
- 6) Adjust the level of the sample solution with distilled / deionized water so that the pH electrode bulb is completely immersed in the sample solution and the reference junction of the electrode is 5-6 mm below the surface.

## 9.7. PERFORMING A TITRATION

From the main screen, press **start stop**. You will be prompted to enter the analyte size. Enter 5 mL and press **enter**. The titrator will start the analysis.

At the end of the titration, the message "Titration Completed" will appear on the display with the final concentration of the analyte in the sample and the equivalence endpoint volume.

## 9.8. TITRATION SCREEN

During a titration, the following screen is displayed:

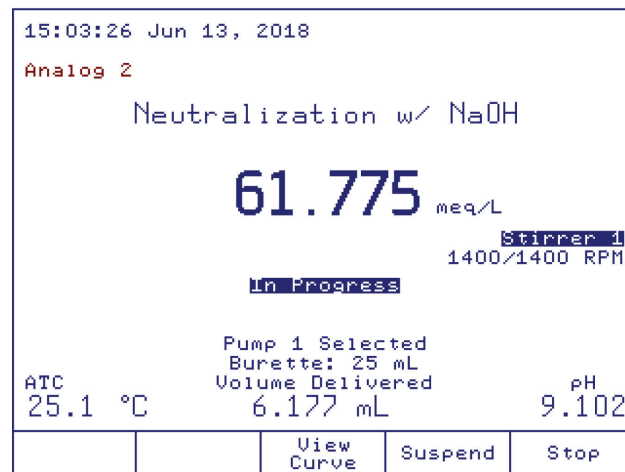

## 9.9. TITRATION GRAPH

After a few doses are dispensed, **View Curve** will become active. Press **View Curve** to display the real-time titration graph. The curves displayed are plots of the pH and the 1st derivative versus Titrant Volume. See [PART 2: INSTRUCTION MANUAL](#) for more information.

The two graphs are scaled to fit in the same screen window. Press **Select Trace** to change the y-axis scale to either the pH values or the 1st derivative values.

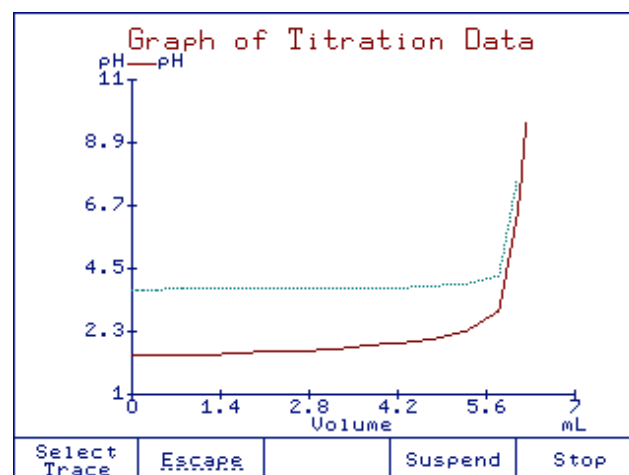

## 9.10. TITRATION TERMINATION

The titration is terminated when the conditions of the Termination Criteria have been met.

The titration is normally terminated when the first equivalence endpoint is detected according to the selected algorithm. To ensure the correct detection and interpolation of the equivalence endpoint, the titrator will dispense a few additional doses after the endpoint was reached.

The titration result can be displayed either in the main screen or in the Graph of Titration Data screen.

When the titration has ended, the titrator will display the equivalence endpoint volume and the final concentration of the analyte together with the "Titration Completed" message.

To view the titration graph and/or results, press **results**.

When the titration ends, an "x" will mark the endpoint on the pH versus titrant volume curve in the Graph of Titration Data screen. The value of the endpoint volume is also displayed next to the endpoint

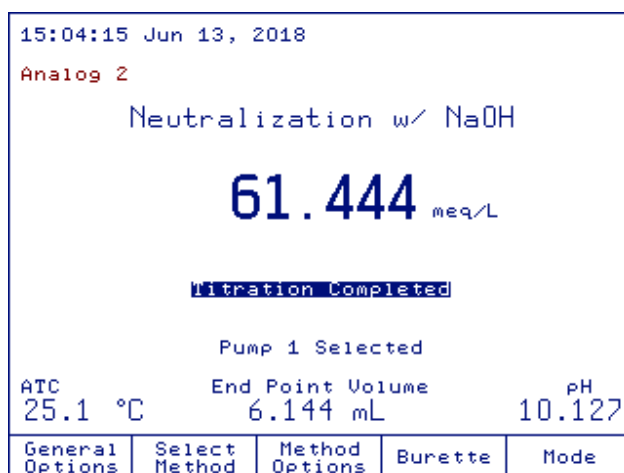

## 9.11. RESULTS

The results obtained from titration are stored in a report file that can be displayed, transferred to a USB storage device or a PC, or printed.

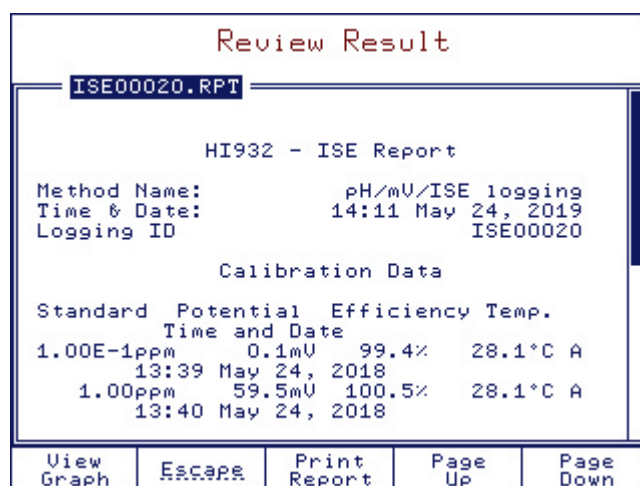



## 9.12. VIEWING THE LAST TITRATION DATA

To view the last titration report:

- 1) From the main screen, press **results**. The **Data Parameters** screen will be displayed.
- 2) From the **Data Parameters** screen highlight *Review Last Report* option and press **Select**. The **Review Result** screen will be displayed.
- 3) Use the **Page Up** and **Page Down** keys to display information related to the last titration performed.

## 9.13. PRINTING THE TITRATION REPORT

Connect a DOS / Windows-compatible parallel printer directly to the DB 25 pin connector located on the back of the titrator.

**Note:** Prior to connecting the printer, ensure that the titrator and the printer have been turned off.

From the **Review Report** screen, press **Print Report**. During the information transfer to the printer, the message "Printing" will be displayed on the screen.

Press **Escape** to return to the **Data Parameters** screen.

Press **Escape** again to return to the main screen.

## 9.14. SAVING DATA TO USB STORAGE DEVICE

**Note:** The USB Storage Device has to be formatted FAT or FAT32.

This feature allows saving the results of titrations or drift logging sessions on a USB storage device.

- 1) From the main screen, press **General Options**, the **General Options** screen will be displayed.
- 2) Highlight *Save Files to USB Storage Device* option using the **▲** and **▼** keys.
- 3) Insert the USB storage device into the USB socket.
- 4) Press **Select**, the **List of Files on Titrator** screen will be displayed.
- 5) Use the **<** and **>** keys to select the report files.

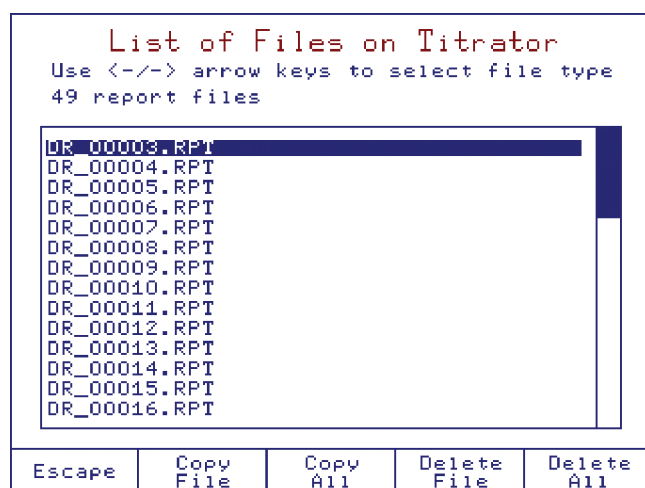

- 6) Press **Copy All** to transfer all available reports to the USB storage device, or highlight the name of the report file to be transferred and press **Copy File**. Transferring a report file will automatically transfer the corresponding log file and titration graph (\*.BMP file if applicable).
- 7) Press **Escape** to return to the **General Options** screen.
- 8) Press **Escape** again to return to the main screen.

## 9.15. TITRATION REPORT

While scrolling with the Page Up and Page Down keys, the fields below can be seen on the titrator display or printed. The same information is available on the saved report file (Ti\_00011.rpt in this example, with all report fields selected).

### HI932 - Titration Report

Method Name: Neutralization w/ NaOH  
 Time & Date: 15:01 Jun 13, 2019  
 Report ID: Ti\_00011

#### Calibration Data

Buffer	Potential	Efficiency	Temp.
Time and Date			
4.010pH	169.3mV	98.8%	24.0°C A
	11:44 Jun 13, 2019		
7.010pH	-5.8mV	98.7%	23.9°C A
	11:42 Jun 13, 2019		
10.010pH	-180.7mV	98.7%	24.0°C A
	11:46 Jun 13, 2019		

#### GLP & Meter Information

Sample Name:  
 Company Name:  
 Operator Name:  
 Electrode Name:  
 Field 1:  
 Field 2:  
 Field 3:  
 Titrator Software Version: v1.00  
 Base Board Software Version: v1.00  
 Pump 1 Software Version: v1.00  
 Pump 2 Software Version: v1.00  
 Stirrer 1 Software Version: v1.00  
 Titrator Serial Number: TT180525011  
 Analog Board1 Serial Number: AB180525005  
 Analog Board2 Serial Number: AB180525006  
 Pump 1 Serial Number: DP180525004  
 Pump 2 Serial Number: DP180525007  
 Stirrer 1 Serial Number: OS180524001  
 Analog 1 Calibration Date: May 25, 2019  
 Analog 2 Calibration Date: May 25, 2019

#### Method Parameters

Name: Neutralization w/ NaOH  
 Method Revision: 3.0  
 Analysis Type: Standard Titration  
 Analog Board: Analog 2  
 Stirrer Configuration:  
     Stirrer: Stirrer 1  
     Stirring Speed: 1400 RPM  
 Pump Configuration:  
     Titrant pump: Pump 1  
 Reagent Addition 1: Disabled  
 Reagent Addition 2: Disabled  
 Dosing Type: Dynamic

```

Min Vol:                0.050 mL
Max Vol:                0.500 mL
delta E:                20.000 mV
End Point Mode:        pH 1EQ point,1st Der
Recognition Options
  Threshold:            50 mV/mL
  Range:                NO
  Filtered Derivatives: NO
Pre-Titration Volume:  0.000 mL
Pre-Titration Stir Time: 0 sec
Measurement Mode:      Signal Stability
  delta E:              1.0 mV
  delta t:              2 sec
  Min wait:             2 sec
  Max wait:             15 sec
Electrode Type:        pH
Blank Option:          No Blank
Calculations:          Sample Calc. by Volume
Dilution Option:      Disabled
Titrant Name:          0.1N HaOH
Titrant Conc.:         0.1000 N (eq/L)
Analyte Size:          10.0000 mL
Analyte Entry:         Fixed
Maximum Titrant Volume: 20.000 mL
Potential Range:       -2000.0 to 2000.0 mV
Volume/Flow Rate:     25 mL / 50.0 mL/min
Signal Averaging:      1 Reading
Significant Figures:   XXXXX

```

N (eq/L) --> meq/L

V eq 1000meq

```

--*--*-----
  L   eq
-----
mL   L
--*--*-----
      1000mL

```

V = volume dispensed in liters.

0.100 eq/L -> titrant conc.

10.000 mL -> sample volume

Nr	Volume [mL]	mV	pH	Graphic	Temp. [°C]	Time
0	0.000	274.4	2.219	0.0	24.9	A 00:00:00
1	0.050	274.4	2.220	1.0	25.0	A 00:00:07
2	0.100	274.4	2.220	0.0	25.0	A 00:00:10
3	0.200	274.3	2.222	-0.8	25.0	A 00:00:12
4	0.400	274.0	2.227	-1.6	25.0	A 00:00:15
5	0.800	273.2	2.241	-2.0	25.0	A 00:00:18
6	1.300	271.5	2.271	-3.4	25.0	A 00:00:24
7	1.800	269.5	2.304	-3.9	25.1	A 00:00:30
8	2.300	267.2	2.344	-4.7	25.1	A 00:00:37
9	2.800	264.4	2.393	-5.7	25.1	A 00:00:43
10	3.300	260.8	2.455	-7.2	25.1	A 00:00:50
11	3.800	256.1	2.535	-9.3	25.1	A 00:00:58
12	4.300	250.3	2.635	-11.7	25.1	A 00:01:05
13	4.800	241.9	2.779	-16.8	25.1	A 00:01:14
14	5.300	228.3	3.011	-27.2	25.1	A 00:01:23
15	5.800	193.0	3.614	-70.5	25.1	A 00:01:31

16	6.077	21.0	6.556	-620.0	25.1	A	00:01:48
17	6.128	-38.2	7.568	-1183.2	25.1	A	00:02:03
18	6.177	-123.6	9.031	-1708.0	25.1	A	00:02:19
19	6.227	-157.7	9.616	-682.8	25.1	A	00:02:28
20	6.278	-174.5	9.903	-335.8	25.1	A	00:02:35
21	6.339	-187.8	10.130	-215.9	25.1	A	00:02:42

#### Titration Results

Method Name: Neutralization w/ NaOH  
Time & Date: 15:01 Jun 13, 2019  
Analyte Size: 10.0000 mL  
End Point Volume: 6.144 mL  
pH Equivalence Point: 8.063  
Result: 61.444 meq/L  
Initial & Final pH: 2.219 to 10.130  
Titration Duration: 2:42 [mm:ss]  
Titration went to Completion

## PART 2:

## INSTRUCTION MANUAL



## 1. SETUP

### 1.1. UNPACKING

Remove the titrator and accessories from the packaging and examine it carefully. For further assistance, please contact your local Hanna Instruments Office or email us at [tech@hannainst.com](mailto:tech@hannainst.com).

Each **HI932** potentiometric titrator is supplied with:

ITEM	QUANTITY
Titrator .....	1 pc.
Pump assembly .....	1 pc.
Burette assembly .....	1 pc.
• Burette with 25 mL syringe	
• Aspiration tube with fitting and protection tube	
• Dispensing tube with dispensing tip, protection tube and tube guide	
• Tube locks	
• Tool for burette cap removal	
• Light spectrum protection screen	
Electrodes holder and stirrer .....	1 pc.
• Stirrer holder	
• Overhead stirrer	
• Propellers (3 pcs.)	
• Support rod	
Burette blank support .....	1 pc.
Pump and burette locking screws with plastic head .....	1 pc.
Temperature sensor .....	1 pc.
Shorting cap .....	1 pc.
Power adapter .....	1 pc.
USB cable .....	1 pc.
Instruction manual .....	1 pc.
USB memory stick .....	1 pc.
HI900 PC application (installation kit on USB memory stick) .....	1 pc.
Quality certificate .....	1 pc.

If any of the items are missing or damaged, please contact your local Hanna Instruments Office or email us at [tech@hannainst.com](mailto:tech@hannainst.com).

See **12.3. TITRATOR COMPONENTS** section for component pictures.

**Note:** Save all packing materials until you are sure that the instrument functions correctly. Any damaged or defective items must be returned in their original packing materials together with the supplied accessories.

## 1.2. SAFETY MEASURES

The following safety measures must be followed:

- Never connect or disconnect the pump assembly or the air pump and magnetic stirrer assembly with the titrator turned on.
- Verify that the burette and the attached tubing are assembled correctly. See [10.1.1. BURETTE ASSEMBLY](#) section for more information.
- Always check that the titrant bottle and the titration beaker are on a flat surface.
- Always wipe up spills and splashes immediately.
- Avoid the following environmental working conditions:
  - Severe vibrations
  - Direct sunlight
  - Atmospheric relative humidity above 95% non-condensing
  - Environment temperatures below 10 °C and above 40 °C
  - Explosion hazards
- Have the titrator serviced only by qualified service personnel.

## 1.3. HI932 TITRATOR TECHNICAL SPECIFICATIONS

Analysis Type	Standard titration (Standardization, Fixed pH / mV, Equivalence point pH / mV)	
	Back titration	
	Direct reading	
Endpoint Mode	Fixed mV	
	Fixed pH	
	mV equivalence point (up to 5 points, 1 <sup>st</sup> or 2 <sup>nd</sup> derivative)	
	pH equivalence point (up to 5 points, 1 <sup>st</sup> or 2 <sup>nd</sup> derivative)	
Burette	Size	5 mL / 10 mL / 25 mL / 50 mL
	Resolution	0.001 mL
	Flow Rate	0.3 mL to 2 x burette volume per minute
	Accuracy	± 0.005 mL (5 mL burette)
		± 0.010 mL (10 mL burette)
± 0.025 mL (25 mL burette)		
± 0.050 mL (50 mL burette)		
Stirrer	Range	200 to 2500 RPM
	Resolution	100 RPM
mV	Range	-2000.0 to 2000.0 mV
	Resolution	0.1 mV
	Accuracy	± 0.1 mV
	Calibration	single point, offset
pH	Range	-2.000 to 20.000 pH
	Resolution	0.1 / 0.01 / 0.001 pH
	Accuracy	± 0.001 pH
	Calibration	up to five points with standard or custom buffers

ISE	Range	$1 \times 10^{-6}$ to $9.999 \times 10^{10}$
	Resolution	1 / 0.1 / 0.01
	Accuracy	$\pm 0.001$ pH
	Calibration	up to five points
Temperature	Range	-5.0 to 105 °C 23.0 to 221.0 °F 268.2 to 378.2 K
	Resolution	0.1 °C / 0.1 °F / 0.1 K
	Accuracy	$\pm 0.1$ °C / $\pm 0.2$ °F / $\pm 0.1$ K
Data Storage	Methods	up to 100 titration methods (standard and user-defined) up to 30 autosampler sequences
	Reports	up to 100 titration and pH / mV / ISE reports up to 40 autosampler tray reports (e.g. 720 reports for 18 beaker tray)
Connections	Measurement (per analog board)	1 x BNC socket (pH, ORP, ISE half-cell and ISE combination electrodes) 1 x 4 mm banana socket (reference electrode) 1 x RCA socket (temperature sensor) 1 x 6-pin connector (stirrer)
	Peripheral	1 x 6-pin mini DIN (external PC keyboard) 1 x DB-25 socket (printer) 1 x USB standard B (PC connection) 1 x DB-9 socket (analytical balance) 1 x USB standard A (USB flash drive)
Additional Specifications	Electrode Holder	4 x multi-purpose slots (titrant / reagent tubes) 3 x 12-mm electrode slots 1 x temperature sensor slot 1 x overhead stirrer slot
	Display	5.7" graphical color display with backlight
	Power Supply	100 - 240 VAC, 50 / 60 Hz
	Power Draw	0.5 amps
	Enclosure Material	ABS, PC and Stainless Steel
	Keypad	Polyester
	Dimensions	315 x 205 x 375 mm (12.4 x 8.1 x 14.8 ")
	Weight	approximately 4.3 kg (9.5 lbs.) with 1 pump, stirrer and sensors
	Operating Environment	10 to 40 °C (50 to 104 °F); up to 95 % RH
	Storage Environment	-20 to 70 °C (-4 to 158 °F); up to 95 % RH



#### 1.4. HI922 AUTOSAMPLER TECHNICAL SPECIFICATIONS

Electrode Holder	5 x multi-purpose slots (titrant / reagent tubes) 3 x 12-mm electrodes slots 1 x overhead stirrer slot 1 x temperature sensor slot 1 x aspiration tube slot
Stirrer	magnetic stirrer (built-in) overhead stirrer (optional)
Temperature Sensor	HI7662-AW (included)
Peristaltic Pumps	up to three (slot 1, 2 or 3)
Diaphragm Pumps	one (slot 4)
Peripheral Units	USB barcode reader
Trays	16 beakers x 150 mL with built-in RFID tag 18 beakers x 100 mL with built-in RFID tag
Beakers	ASTM short-form glass beakers, 100 & 150 mL HI920-060 150 mL plastic beakers HI920-053 100 mL plastic beakers
Control Panel	buttons for manual operation of tray manual operation of peristaltic or diaphragm pumps 2-line backlit display with status information
Enclosure Material	ABS plastic and steel
Electrode Holder Material	ABS plastic
Tray Material	ABS plastic and acrylic
Keypad Material	ABS plastic and polycarbonate
Weight	approximately 13 kg (29 lbs)
Operating Environment	10 to 40 °C, up to 95% RH
Storage Environment	-20 to 70 °C, up to 95% RH

1.5. INSTALLATION

1.5.1. TITRATOR FRONT VIEW

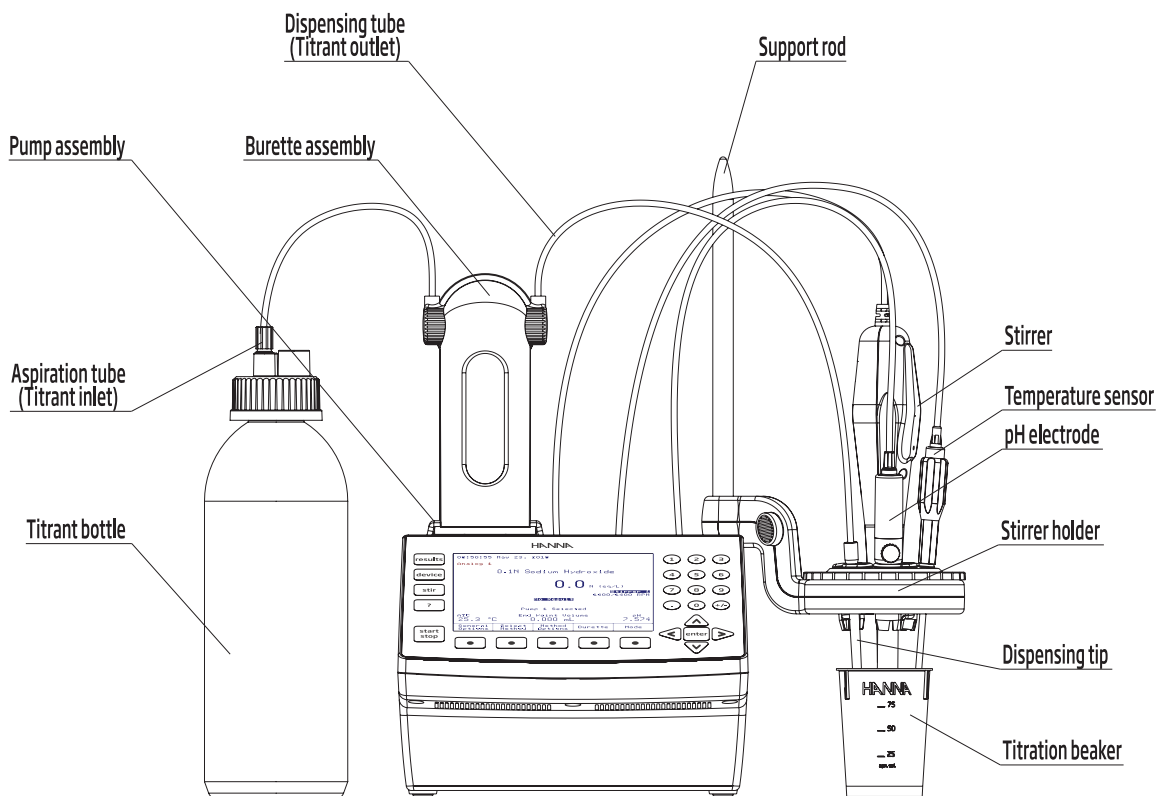

1.5.2. TITRATOR REAR VIEW

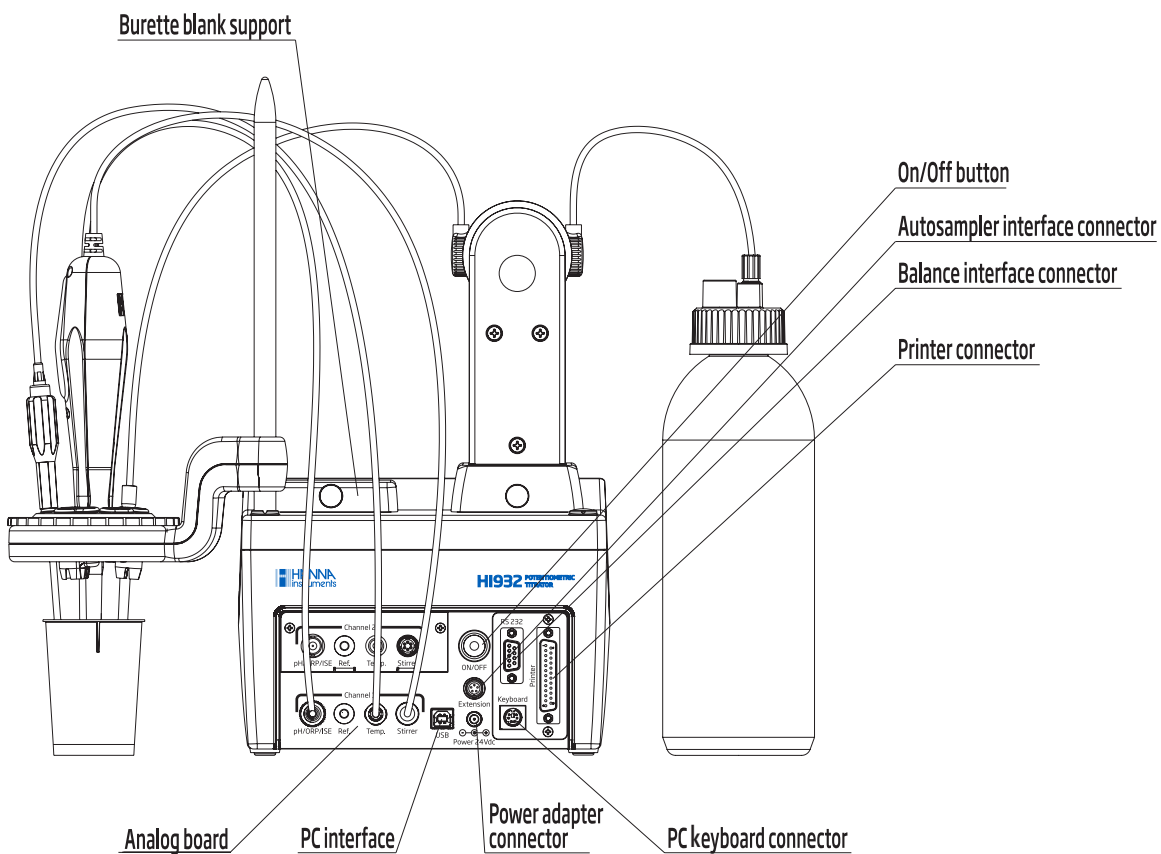



## 1.5.5. TITRATOR ASSEMBLY

**Note:** Assembly operations must be completed before connecting the titrator to the power supply!

### 1.5.5.1. Assembling Support Rod

To insert support rod into the titrator case:

1. Remove protective cap from titrator case
2. Insert the support rods into the titrator case
3. Turn the support rod clockwise to secure it in place

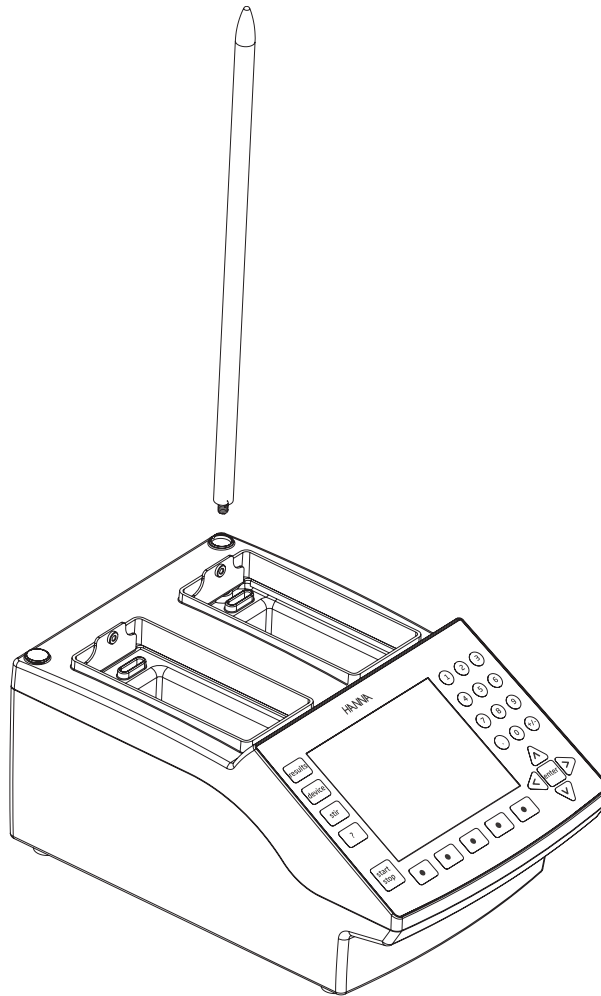

### 1.5.5.2. Attaching Stirrer & Electrode

To attach the stirrer to the titrator, follow these steps:

1. Place the electrode holder (B) in the stirrer support housing (A). The stirrer support housing can be inverted if necessary.
2. Slide the electrode holder into the support rod and set the desired height using the holder button.
3. Insert electrode (C), temperature sensor (D) and stirrer (E) into the dedicated holes in the electrode holder. Push them until they are in a stable position.

**Note:** For small sample sizes, use the electrode adapter (F) in the center of the holder.

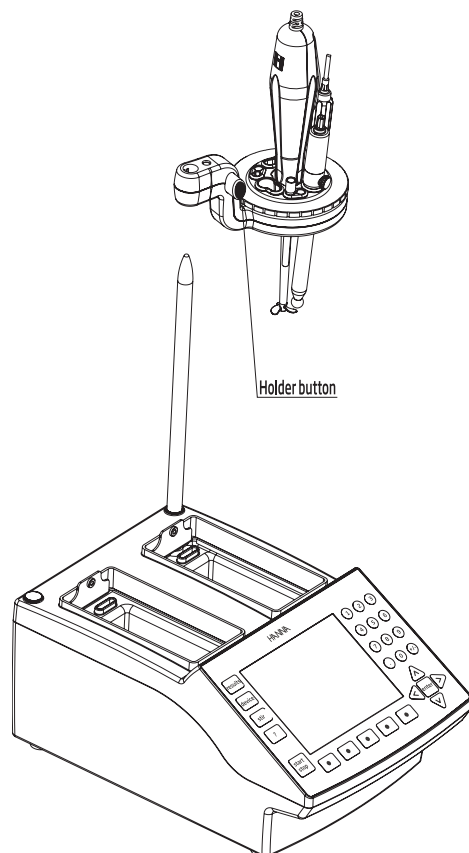
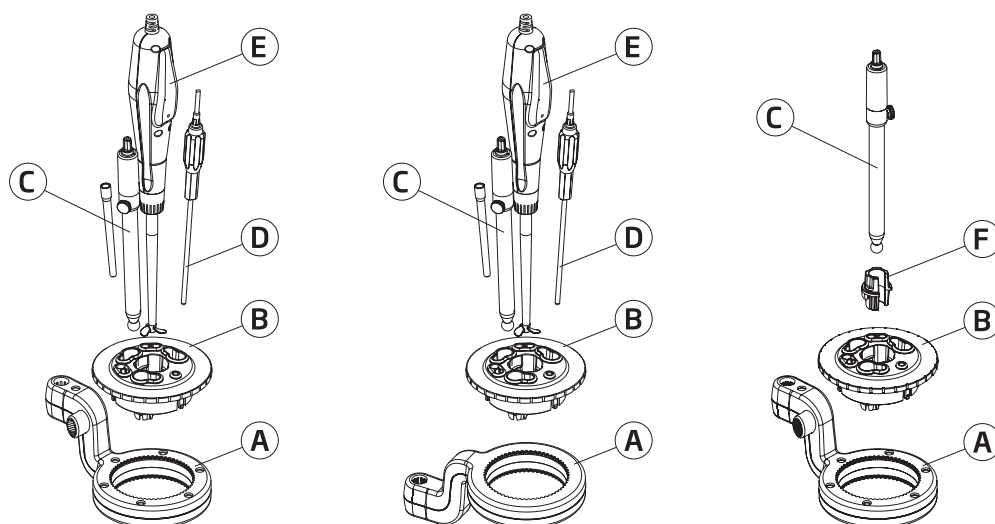

### 1.5.5.3. Connecting the Pump

To connect the pump, follow these steps:

1. Retrieve the pump cable from inside the bay. The pump 1 connector is located in the left bay and pump 2 connector in the right bay.
2. Connect the cable to the pump as shown below. The pump connector is located on the bottom of the pump.
3. Lower the pump into the titrator, then slide it towards the front of the titrator case until it is firmly latched.
4. Secure the pump with the locking screw.

This procedure can be repeated to connect a second pump.

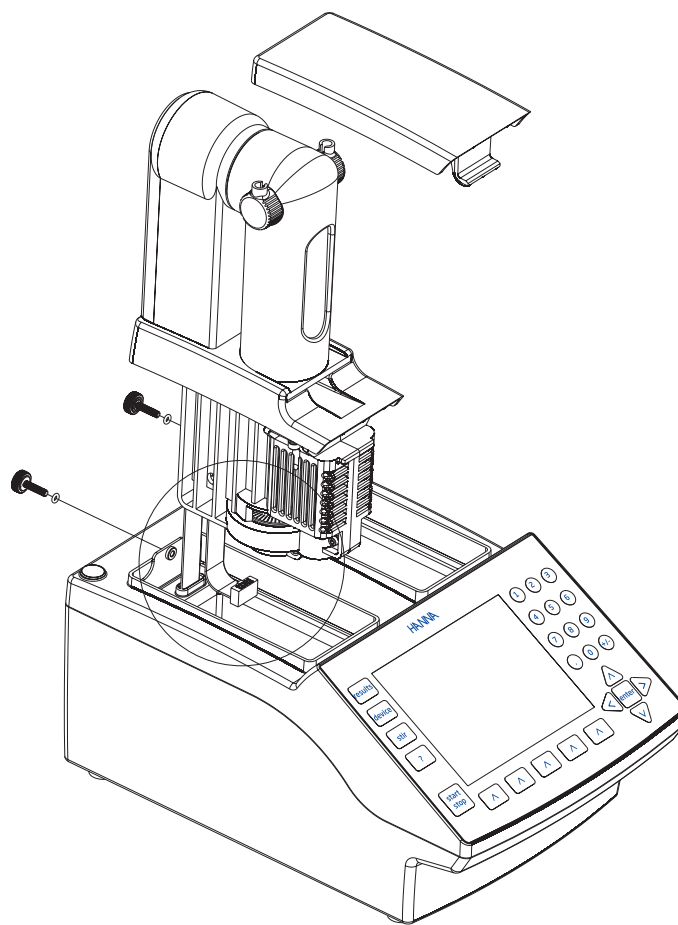
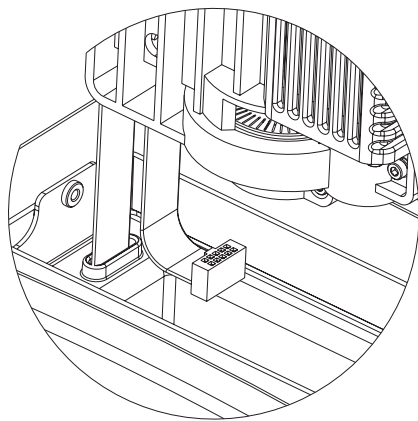

### 1.5.5.4. Attaching Burette Blank Support

To attach the support, follow these steps:

1. Insert and lower the burette blank support into the titrator's bay.
2. Slide it towards the front of the titrator case until it is firmly latched.
3. Secure the burette blank support with the locking screw.

### 1.5.5.5. Attaching the Burette

To attach the burette to the pump, follow these steps:

1. Make sure that the mark from the valve actuating cap and from the burette body are aligned.

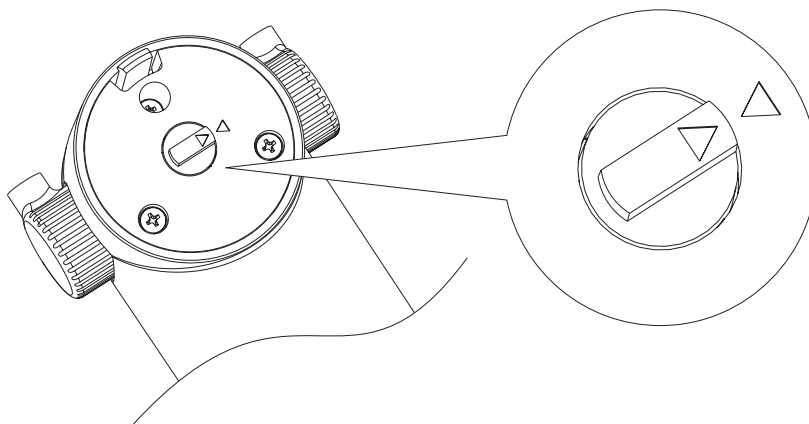

2. Slide the burette into the support on the burette pump. Ensure correct coupling between the syringe plunger (A) and the pump piston (B).

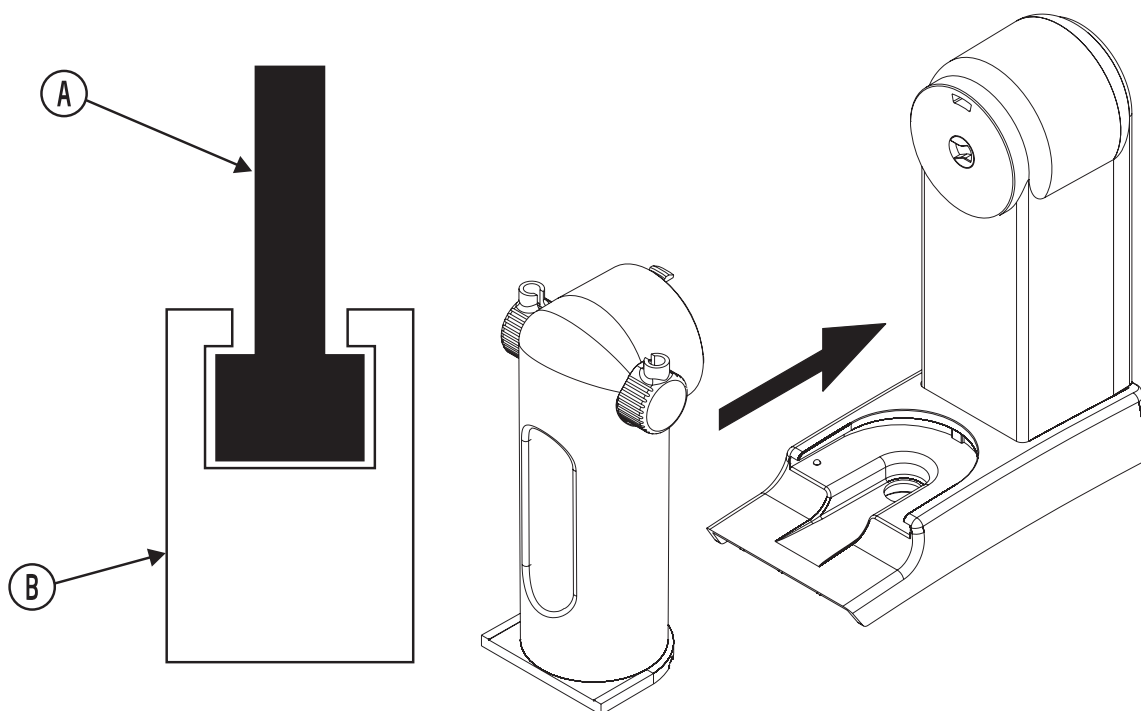

### 1.5.5.6. Connecting Peristaltic Pump Tubing

To attach the pump tubing to the burette pump with the built-in peristaltic pump:

1. Use a screw driver to remove the plastic cover (E) from the pump.
2. Remove the blue tube connectors (F).
3. Insert the roller tube (C) into the left side of the holder (D). The fitting on the top of the roller tube will sit on the top of the housing.
4. Manually rotate the pump (A) counterclockwise until the tubing is mounted on the pump.
5. Insert the roller tube (B) into the right side of the holder (G). The fitting on the top of the roller tube will sit on the top of the housing.
6. Attach aspiration and dispensing tubing to the roller tubing and replace the blue tube connectors (F).
7. Replace the plastic cover (E).

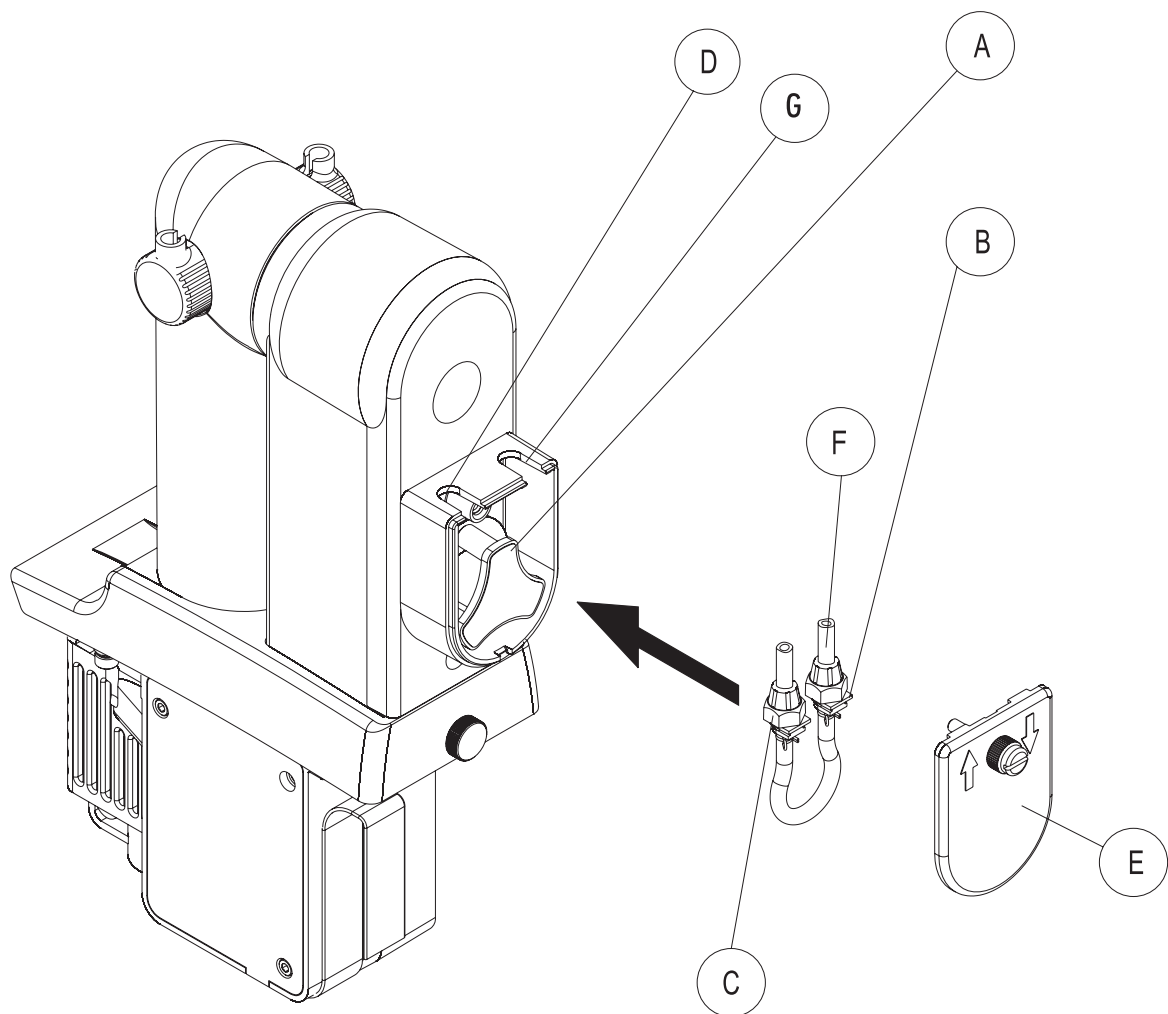



### 1.5.6. ELECTRICAL CONNECTIONS

1. Connect the electrode to the BNC connector (A).
2. Connect the temperature sensor to the RCA connector (C).
3. Connect the stirrer to the MINI-DIN connector (D).
4. Connect the power adapter cable to the power input connector (F).

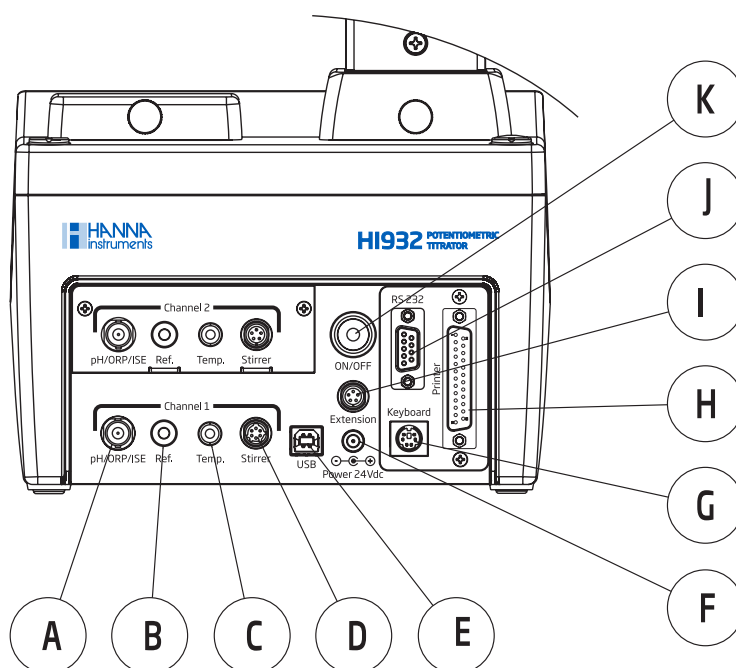

	Function	Type of Connector
A	Connection for pH, ORP, ISE half-cell and ISE combination electrodes	BNC socket
B	Reference electrode	Ø 4 mm banana socket
C	Temperature sensor	RCA socket
D	Stirrer	6-pin connector
E	USB interface	USB standard B
F	Power input connector (24 VDC)	DC power jack connector
G	External PC keyboard	6-pin mini DIN (Standard PS2)
H	Printer	DB-25 socket
I	Connector for autosampler	5-pin connector
J	Balance interface	DB-9 socket (RS-232)
K	Power switch	

## 2. USER INTERFACE

### 2.1. START UP

Once the instrument is assembled and installed, follow the steps below to start the titrator:

1. Connect the titrator to a power outlet with the supplied power adapter.
2. Turn on the titrator using the power button located on the back of the instrument.
3. Wait until the titrator finishes the initialization process.
4. Press  when prompted or wait a few seconds for titrator to start.



**Note:** All the performed initialization processes must be successfully completed. If one fails, restart the titrator. If the problem persists, contact your nearest Hanna Instruments Service Center.



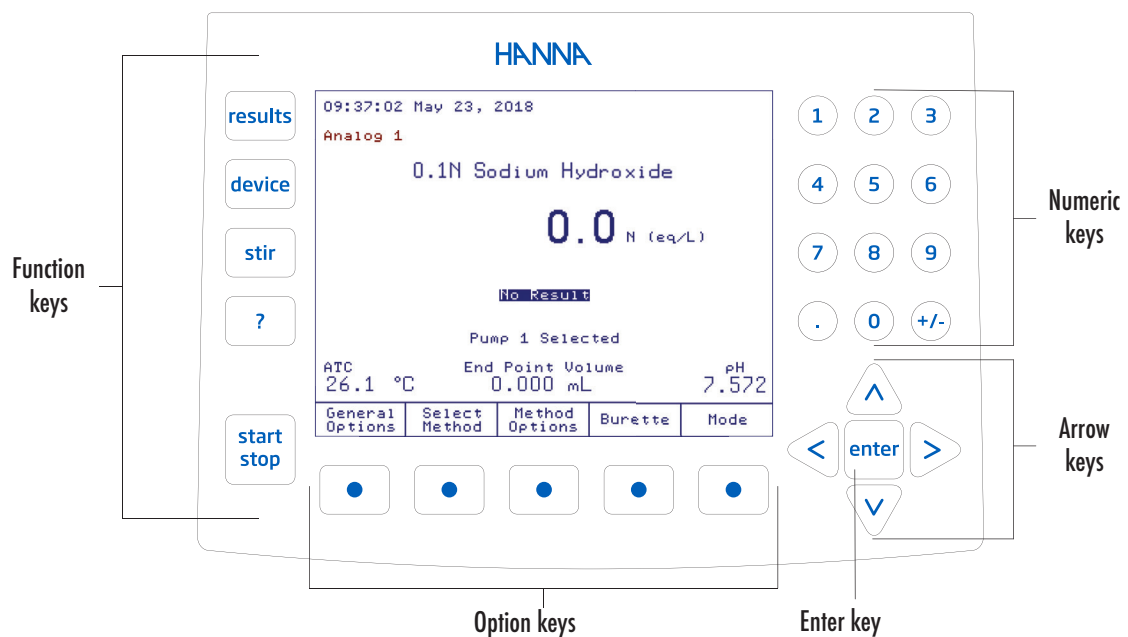

### 2.2. KEYPAD

The titrator's keypad is grouped into five categories, as follows:



### 2.2.1. FUNCTION KEYS

If one of these keys is pressed, the associated function is immediately performed. Some of the keys are active only in specific screens:

-  Starts or stops a titration process
-  Turns the selected stirrer on and off
-  Access the autosampler
-  Access the data parameters menu (reports, GLP, meter information, report setup)
-  Displays contextual help

### 2.2.2. OPTION KEYS

These keys are assigned to the virtual keys on the display. Their functions are listed in the boxes above the buttons and vary depending on the displayed screen.





An underlined virtual key can also be activated by pressing .

### 2.2.3. ARROW KEYS

These keys have the following functions:

- Move the on-screen cursor.
- Increase or decrease the stirrer speed and other settings.
- Select a character (alphanumeric screen only).
- Navigate through menu options.

### 2.2.4. NUMERIC KEYS

-  to  Used for numeric entries.
-  Toggles between positive and negative values.
-  Used for decimal point.

### 2.2.5. ENTER KEY

This key has the following functions:

- Accepts alphanumeric data entry.
- Executes the default (underlined) virtual option key.

## 2.3. DISPLAY

The titrator has a large color graphical display. The main screen is shown below with short explanations of the screen segments.

### 2.3.1. THE MAIN SCREEN

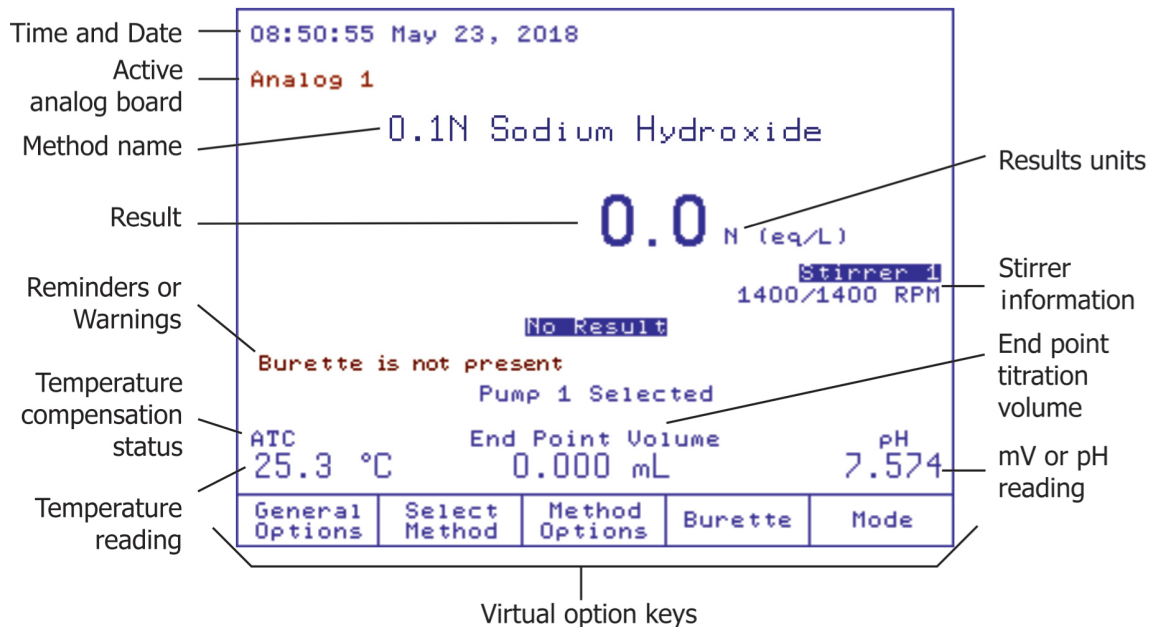

The user interface contains several screens. For each titrator function, several screens may be used.

<b>Method name</b>	Displays the name of the selected method.
<b>Time and Date</b>	Displays the current date and time.
<b>Temperature reading</b>	Displays the measured temperature.
<b>ATC</b>	Automatic temperature compensation
<b>Manual</b>	Manual temperature compensation
<b>Manual</b>	Temperature probe is not connected, manual temperature compensation
<b>Stirrer information</b>	The selected stirrer, actual and set stirrer speed is displayed in RPM. When stirrer is off, the stirrer information is not displayed.
<b>Endpoint volume</b>	Displays the volume delivered to reach the titration endpoint. When no titration has been performed, the displayed volume is "0.000 mL".
<b>Result</b>	Displays the titration result or the direct reading measurement.
<b>mV or pH reading</b>	Displays the current reading. The reading will be in mV or pH.
<b>mV</b>	Indicates actual potential reading.
<b>rel mV</b>	Indicates relative potential reading.
<b>pH</b>	Indicates actual pH value.
<b>Titration status</b>	Displays the status of the selected titration.
	<b>No Result</b> is displayed when a titration has not been performed.
<b>Reminders</b>	Indicates when a task needs to be performed and displays errors.
<b>Pump 1 selected</b>	Displays the active pump.
<b>Analog 1</b>	When two analog boards are present, the active one is shown.

## 2.4. MENU NAVIGATION

### 2.4.1. SELECTING AN OPTION

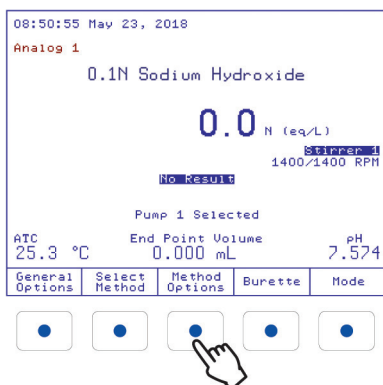

Press the option key below the virtual key. For example, to access the **Method Options** screen, press the option key below it.

### 2.4.2. SELECTING A MENU ITEM

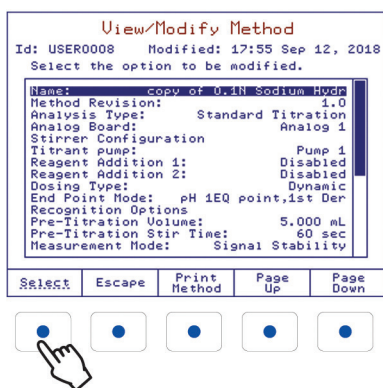

Use the and arrow keys to move the cursor.

When the menu is larger than the display, a scroll bar is active on the right side.

The and keys can be used to scroll through the pages.

To activate the selected menu item, press or .

### 2.4.3. ENTERING TEXT

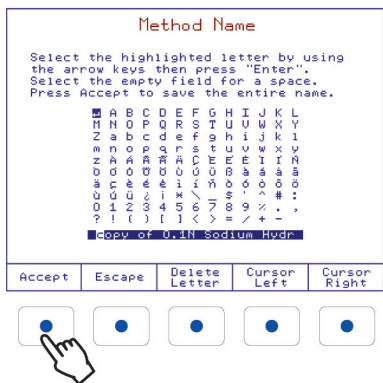

Use to erase previous text. Use the arrow keys to highlight the letter then press . Use the same procedure to enter the whole name.

For editing, use the and keys.

When editing is complete, press .

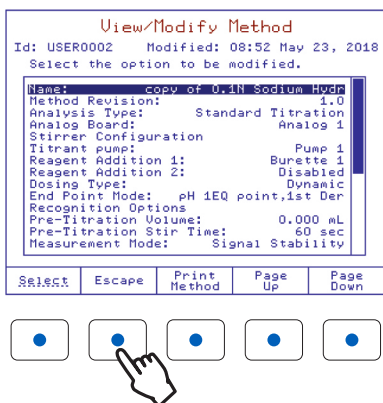

The method name will be updated and displayed in the name field of the **View / Modify Method** screen.

When all the desired parameters have been set, press .

## 2.4.4. SAVING MODIFICATIONS

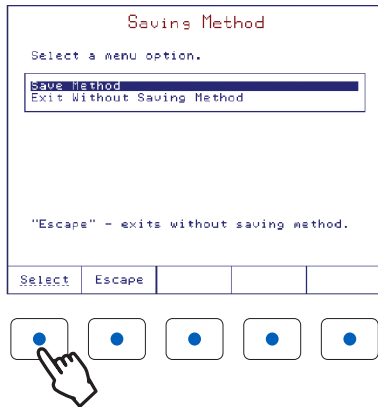

The **Saving Method** screen allows the user to save the modifications. To exit without saving, press **Escape** or highlight *Exit Without Saving Method* option and then press **Select**. To save the modifications, highlight *Save Method* option and then press **Select**.

**Note:** To access the contextual help menu, press **?** at any time. Help is related to the displayed screen. Press **Escape** or **?** to return to the previous screen.

### 3. GENERAL OPTIONS

The **General Options** screen gives access to options that are not directly related to the titration process or pH / mV / ISE measurement. To access this screen, press  from the main screen.

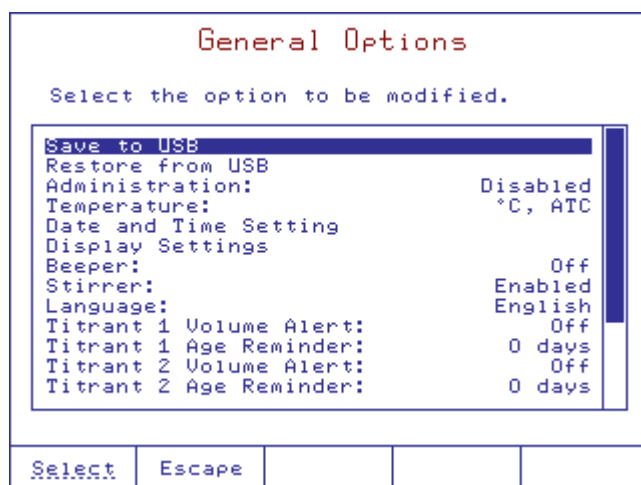

#### 3.1. SAVE TO USB

This option allows the user to save files from the titrator to a USB storage device.

**Note:** The USB Storage Device has to be formatted FAT or FAT32.

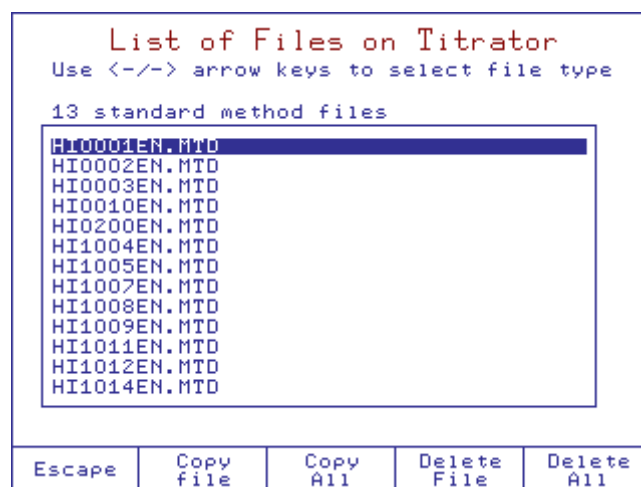

On the titrator, the available file types are:

**Standard method** HIXXXYY.MTD (e.g.: HI0001EN.MTD, HI1004EN.MTD)

**User-defined method** USERXXX.MTD (e.g.: USER0001.MTD)

**Report** Ti\_XXXXX.RPT, mV\_XXXXX.RPT, pH\_XXXXX.RPT, ISEXXXXX.RPT, mVrXXXXX.RPT (e.g.: Ti\_00001.RPT, mV\_00001.RPT, pH\_00001.RPT, ISE00001.RPT, mVr00001.RPT)

Insert the USB storage device into the USB port on the right side of the titrator.

Use the  and  keys to select the file type. The number of files and the file names will be displayed.

Use the  and  keys to scroll through the list.

The option keys allow the following operations:

- Escape Returns to the **General Options** screen.
- Copy File Copies highlighted file from the titrator to USB storage device.
- Copy All Copies all displayed files from the titrator to USB storage device.
- Delete File Deletes the highlighted file.
- Delete All Deletes all displayed files.

**Note:** The saved files will be stored on the USB key in the **HI932** folder, as follows:

**Methods**      USB Drive\HI932\Methods\\*.mtd

**Reports**      USB Drive\HI932\Reports\\*.rpt

### 3.2. RESTORE FROM USB

This screen allows the user to transfer files from the USB storage device to the titrator.

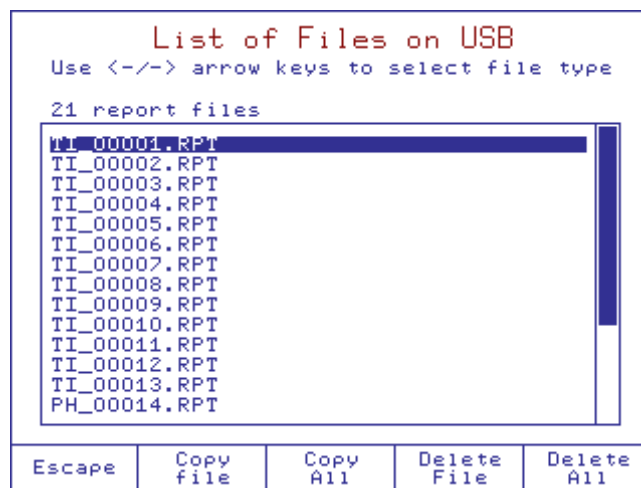

The file types that can be transferred are:

**Standard method**      HIXXXYY.MTD (e.g.: HI0001EN.MTD, HI1004EN.MTD)

**User-defined method**      USERXXX.MTD (e.g.: USER0001.MTD)

**Report**      Ti\_XXXX.RPT, mV\_XXXX.RPT, pH\_XXXX.RPT, ISEXXXX.RPT, mVrXXXX.RPT (e.g.:  
Ti\_00001.RPT, mV\_00001.RPT, pH\_00001.RPT, ISE00001.RPT, mVr00001.RPT)

Insert the USB storage device into the USB port on the right side of the titrator.

Use the < and > keys to select the file type. The number of files and the file names will be displayed.

Use the ^ and v keys to scroll through the list.

The option keys allow the following operations:

- Escape Returns to the **General Options** screen.
- Copy File Copies the highlighted file from the USB storage to the titrator.
- Copy All Copies all displayed files from the USB storage to the titrator.
- Delete File Deletes the highlighted files from the USB storage device.
- Delete All Deletes all displayed files from the USB storage device.

**Note:** In order to restore files from USB Key, please ensure that the methods and / or reports you wish to transfer to the titrator are in the correct folder:

**Methods**      USB Drive\HI932\Methods\\*.mtd

**Reports**      USB Drive\HI932\Reports\\*.rpt



### 3.3. ADMINISTRATION

A 4-digit numeric PIN can be set to prevent unauthorized changes from being made.

When the user enters administration mode and a pin has not been set, the user will be prompted to enter a new PIN.

Titrator Administration				
Administrator PIN has not been set. Enter a 4-digit PIN to enable Administrator function.				
Enter PIN: <input type="password" value="----"/>				
Confirm PIN: <input type="password" value="----"/>				
Your PIN must be 4-digits long.				
Next	Escape	Delete Digit		

Once a PIN has been set, the titrator can be locked. When a titrator is locked, the users cannot modify methods or delete reports. Basic functions are still available (review reports, save to USB, etc.).

Titrator Administration								
Titrator is UNLOCKED.								
<table border="1"> <thead> <tr> <th colspan="2">Lock Titrator</th> </tr> </thead> <tbody> <tr> <td>Enter PIN:</td> <td><input type="password" value="----"/></td> </tr> </tbody> </table>					Lock Titrator		Enter PIN:	<input type="password" value="----"/>
Lock Titrator								
Enter PIN:	<input type="password" value="----"/>							
Accept	Escape	Delete Digit						

To return to administration mode, the titrator can be unlocked by entering the PIN.

Titrator Administration				
Titrator is LOCKED.				
Unlock Titrator	Escape			Recovery PIN

If the PIN is lost or forgotten, press recovery pin and contact technical support to supply the required information.

<b>Recovery PIN</b>				
For recovery PIN, please contact your vendor. When requesting PIN please provide following information:				
Titration Serial Number: 12345678				
Code: 0078				
Recovery PIN: <input type="password" value="----"/>				
Accept	Escape	Delete Digit		

### 3.4. TEMPERATURE

The temperature menu allows access to all three menu options related to temperature: source, setting and units.

<b>Temperature Menu</b>							
Select temperature option to be modified.							
<table border="1"><tr><td>Temperature Source</td></tr><tr><td>Manual Temperature Setting</td></tr><tr><td>Temperature Units</td></tr></table>					Temperature Source	Manual Temperature Setting	Temperature Units
Temperature Source							
Manual Temperature Setting							
Temperature Units							
Select	Escape						

### 3.4.1. TEMPERATURE SOURCE

#### Option: Automatic Temperature or Manual Temperature

Select the temperature source used for temperature compensation.

When Automatic Temperature is selected, "ATC" is displayed on the main screen and the temperature is read by the temperature probe.

When Manual Temperature is selected, "Manual" is displayed on the main screen and a preset temperature value is used for temperature compensation.

**Note:** The selected temperature source will be indicated in the report files: A for Automatic and M for Manual.

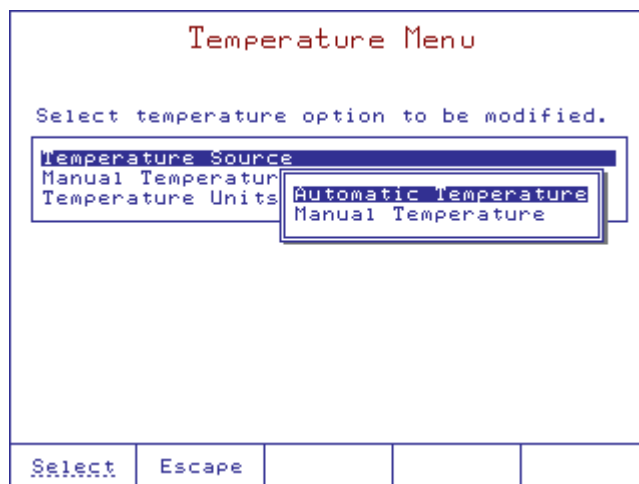

### 3.4.2. MANUAL TEMPERATURE SETTING

#### Option: -5.0 to 105.0 °C (23.0 to 221.0 °F, 268.2 to 378.2 K)

If the temperature probe is not connected, the user can manually set the temperature used by the titrator for compensation.

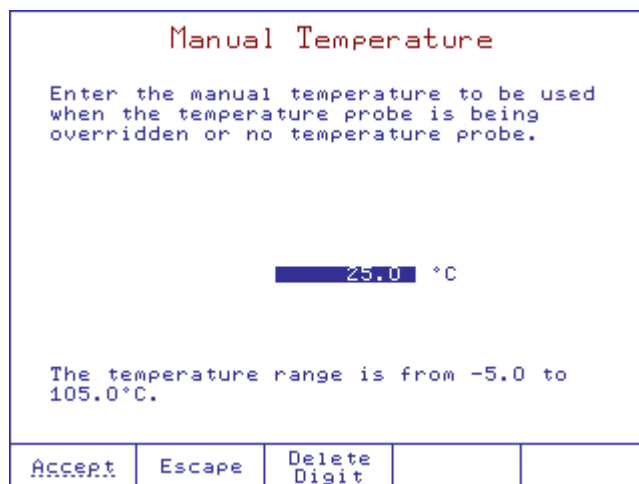

### 3.4.3. TEMPERATURE UNITS

Option: °C, °F, K

The temperature ranges are as displayed in the **Temperature Units** screen.

Temperature Menu				
Select temperature option to be modified.				
<div style="border: 1px solid black; padding: 2px;">           Temperature Source            Manual Temperature Setting  <b>Temperature Units</b> </div>				
<div style="border: 1px solid black; padding: 2px; margin-left: 40px;">           Celsius    -5.0 to 105.0 °C            Fahrenheit 23.0 to 221.0 °F            Kelvin     268.2 to 378.2 K         </div>				
Select	Escape			

### 3.5. DATE & TIME SETTING

This screen allows the user to set the date and time.

Use the  and  keys or the numeric keys to modify the date and time.

 Moves move the cursor to the next field.

 or  Changes the time format.

Date and Time Setting				
Enter the date.				
2	10	2018		
day	month	year		
Enter the time.				
20	41	41		
hour	minute	second		
Press <Next> to move to the next entry.				
Accept	Escape	Delete Digit	Next	AM/PM

### 3.6. DISPLAY SETTINGS

This screen allows the user to customize the display settings.

 Increases the backlight time-saver interval.

 Decreases the backlight time-saver interval.

The backlight intensity can be adjusted using the  and  keys.

There are 8 levels of backlight intensity, ranging from 0 to 7.

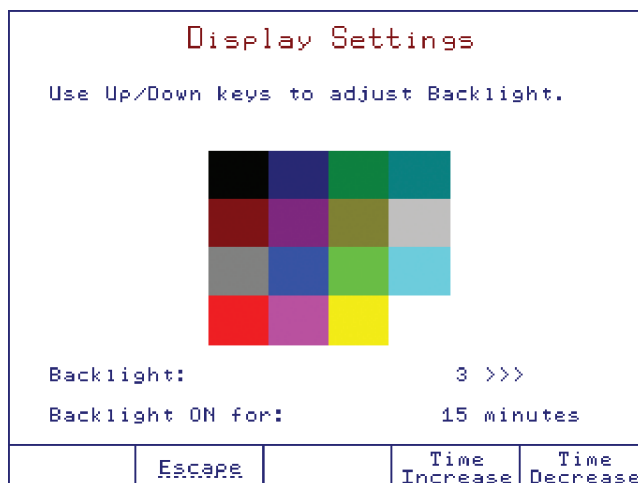

The displayed color palette allows for selection of appropriate backlight intensity.

The backlight time-saver option protects the display during standby periods, when no keys have been pressed for a set amount of time, the backlight will turn off.

If the backlight is off, press any key to reactivate the backlight.

The range for backlight time-saver interval is between 1 and 60 minutes. To disable the backlight time-saver, increase the time to the maximum allowed, the Off indication will be displayed.

### 3.7. BEEPER

**Option: On or Off**

If enabled (on) an audible alert will sound after a titration is completed, when an invalid key is pressed or when a critical error occurs during titration.

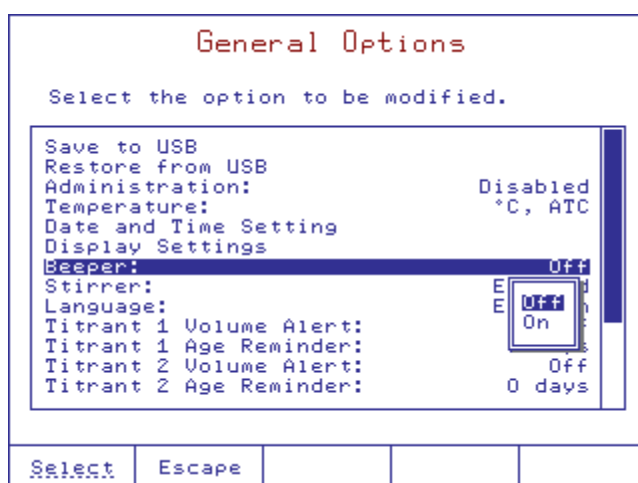



### 3.8. STIRRER

#### Option: Enabled or Disabled

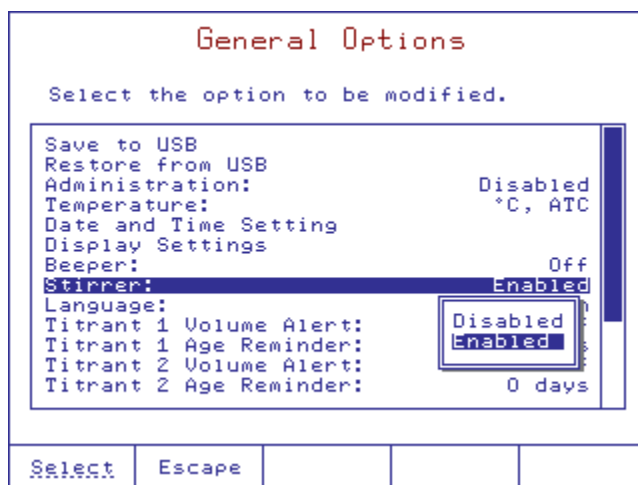
The stirrer can be disabled in individual titration method, if necessary.



### 3.9. LANGUAGE

Using the  and  keys, select the language from the options listed and press . Restart the titrator in order to apply the new language setting.

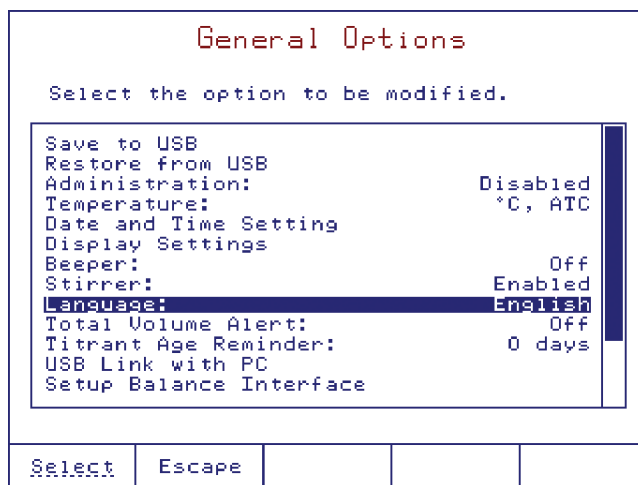

### 3.10. TOTAL VOLUME ALERT

Option: Off, 0 to 10000 mL

This screen allows a programmable reminder to appear when the titrant reservoir is below 100 mL. The titrant volume will decrease as the titrant is used.

After the new titrant volume has been entered in the **Total Volume Alert** screen, a warning message appears on the main screen reminding the user to re-standardize the newly added titrant.

Off Disables this option.

<b>Titrant 1 Volume Alert</b>				
Enter the amount of titrant available to the titration/reagent system from its reservoir. The mLs will decrease as the titrant/reagent is depleted.				
1000 mL				
A reminder will appear when less than 100 mLs of titrant volume is left.				
Accept	Escape	Delete Digit		Off

### 3.11. TITRANT AGE REMINDER

Option: Off, 0 to 31 days

A programmable reminder will appear when it is time to verify the titrant concentration or to change the titrant.

Off Disables this option.

<b>Titrant 1 Age Reminder</b>				
Enter the number of days to pass since the last Titr. Vol. updating or the last Start pressing, whereafter the reminder appears.				
30 days				
The range is from 0 to 31 days.				
Start	Escape	Delete Digit		Off

### 3.12. USB LINK WITH PC

In order to use this feature, the USB cable needs to connect the titrator with the PC. Make sure that **HI900** PC application is running on the PC.

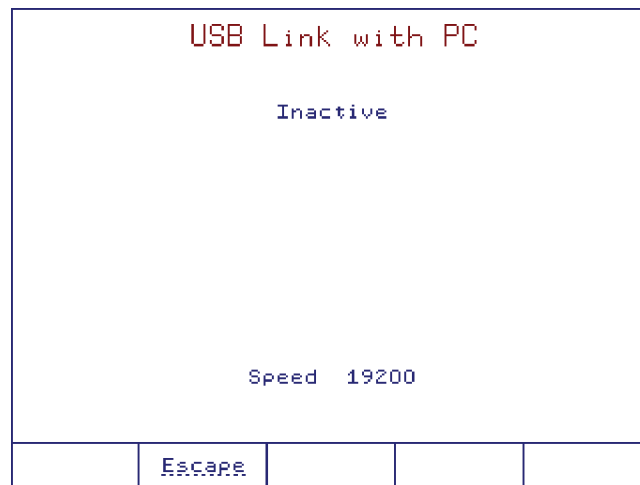

“Active / Inactive” message shows the status of the USB link with the PC.

“Active” means that the titrator is using the USB communication with the PC and not with another device.

“Ready” shows that the titrator is able to communicate with the PC.

During transfer of information between the PC and the titrator, press “Transmit” and the status is displayed.

### 3.13. SETUP BALANCE INTERFACE

This screen allows the user to setup an analytical balance for automatic acquisition of sample mass prior to titration or standardization.

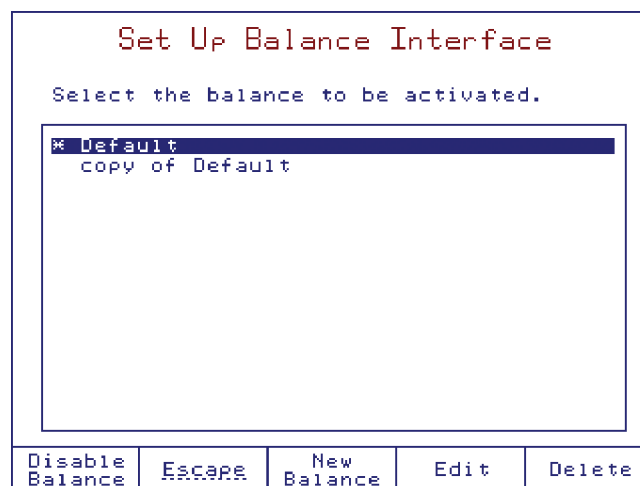

The balance is connected to the titrator via RS 232 interface.

- Enables the selected balance.
- Disables the selected balance (automatic weight acquisition will not be available).
- Returns to the **General Options** screen.
- Adds a new balance to the list.
- Customizes the serial communication parameters. The **Balance Configuration** screen will open.
- Deletes the highlighted balance.

**Note:** *At least one balance must be in the list.*



Be sure that the balance configuration settings match the settings of your balance. It may be necessary to change settings on your balance or titrator. Users should consult their balance instruction manual.

Verify connection with the balance is working properly by pressing the  key.

Balance Configuration																
Select the option to be modified.																
<table border="1"> <thead> <tr> <th>Balance Name</th> <th>Default</th> </tr> </thead> <tbody> <tr> <td>Baud Rate</td> <td>9600</td> </tr> <tr> <td>Data Bits</td> <td>8 Bits</td> </tr> <tr> <td>Parity</td> <td>No Parity</td> </tr> <tr> <td>Stop Bit</td> <td>1 bit</td> </tr> <tr> <td>Edit Request Command</td> <td>B</td> </tr> </tbody> </table>					Balance Name	Default	Baud Rate	9600	Data Bits	8 Bits	Parity	No Parity	Stop Bit	1 bit	Edit Request Command	B
Balance Name	Default															
Baud Rate	9600															
Data Bits	8 Bits															
Parity	No Parity															
Stop Bit	1 bit															
Edit Request Command	B															
Select	Escape		Test Balance													

### 3.13.1. BALANCE NAME

**Option: Up to 24 characters**

Assign a name for your customized balance.

Balance Name																																																																																																																																																																																																
Select the highlighted letter by using the arrow keys then press "Enter". Select the empty field for a space. Press Accept to save the entered text.																																																																																																																																																																																																
<table border="1"> <tbody> <tr><td>█</td><td>A</td><td>B</td><td>C</td><td>D</td><td>E</td><td>F</td><td>G</td><td>H</td><td>I</td><td>J</td><td>K</td><td>L</td></tr> <tr><td></td><td>M</td><td>N</td><td>O</td><td>P</td><td>Q</td><td>R</td><td>S</td><td>T</td><td>U</td><td>V</td><td>W</td><td>X</td><td>Y</td></tr> <tr><td></td><td>Z</td><td>a</td><td>b</td><td>c</td><td>d</td><td>e</td><td>f</td><td>g</td><td>h</td><td>i</td><td>j</td><td>k</td><td>l</td></tr> <tr><td></td><td>m</td><td>n</td><td>o</td><td>p</td><td>q</td><td>r</td><td>s</td><td>t</td><td>u</td><td>v</td><td>w</td><td>x</td><td>y</td></tr> <tr><td></td><td>z</td><td>À</td><td>Á</td><td>Â</td><td>Ã</td><td>Ä</td><td>Å</td><td>Æ</td><td>Ç</td><td>È</td><td>É</td><td>Ê</td><td>Ë</td><td>Ì</td><td>Í</td><td>Î</td><td>Ï</td><td>Ñ</td></tr> <tr><td></td><td>Ò</td><td>Ó</td><td>Ô</td><td>Õ</td><td>Ö</td><td>Ù</td><td>Ú</td><td>Û</td><td>Ü</td><td>ß</td><td>à</td><td>á</td><td>â</td><td>ã</td><td>ä</td><td>å</td><td>æ</td><td>ç</td></tr> <tr><td></td><td>è</td><td>é</td><td>ê</td><td>ë</td><td>ì</td><td>í</td><td>î</td><td>ï</td><td>ò</td><td>ó</td><td>ô</td><td>õ</td><td>ö</td><td>ø</td><td>ù</td><td>ú</td><td>û</td><td>ü</td></tr> <tr><td></td><td>ý</td><td>ÿ</td><td>ı</td><td>ı</td><td>ı</td><td>ı</td><td>ı</td><td>ı</td><td>ı</td><td>ı</td><td>ı</td><td>ı</td><td>ı</td><td>ı</td><td>ı</td><td>ı</td><td>ı</td><td>ı</td></tr> <tr><td></td><td>0</td><td>1</td><td>2</td><td>3</td><td>4</td><td>5</td><td>6</td><td>7</td><td>8</td><td>9</td><td>%</td><td>.</td><td>,</td><td></td><td></td><td></td><td></td><td></td></tr> <tr><td></td><td>?</td><td>!</td><td>(</td><td>)</td><td>[</td><td>]</td><td>&lt;</td><td>&gt;</td><td>=</td><td>/</td><td>+</td><td>-</td><td></td><td></td><td></td><td></td><td></td><td></td></tr> <tr><td></td><td colspan="13">█ Lab Balance</td><td></td><td></td><td></td><td></td><td></td></tr> </tbody> </table>					█	A	B	C	D	E	F	G	H	I	J	K	L		M	N	O	P	Q	R	S	T	U	V	W	X	Y		Z	a	b	c	d	e	f	g	h	i	j	k	l		m	n	o	p	q	r	s	t	u	v	w	x	y		z	À	Á	Â	Ã	Ä	Å	Æ	Ç	È	É	Ê	Ë	Ì	Í	Î	Ï	Ñ		Ò	Ó	Ô	Õ	Ö	Ù	Ú	Û	Ü	ß	à	á	â	ã	ä	å	æ	ç		è	é	ê	ë	ì	í	î	ï	ò	ó	ô	õ	ö	ø	ù	ú	û	ü		ý	ÿ	ı	ı	ı	ı	ı	ı	ı	ı	ı	ı	ı	ı	ı	ı	ı	ı		0	1	2	3	4	5	6	7	8	9	%	.	,							?	!	(	)	[	]	<	>	=	/	+	-								█ Lab Balance																	
█	A	B	C	D	E	F	G	H	I	J	K	L																																																																																																																																																																																				
	M	N	O	P	Q	R	S	T	U	V	W	X	Y																																																																																																																																																																																			
	Z	a	b	c	d	e	f	g	h	i	j	k	l																																																																																																																																																																																			
	m	n	o	p	q	r	s	t	u	v	w	x	y																																																																																																																																																																																			
	z	À	Á	Â	Ã	Ä	Å	Æ	Ç	È	É	Ê	Ë	Ì	Í	Î	Ï	Ñ																																																																																																																																																																														
	Ò	Ó	Ô	Õ	Ö	Ù	Ú	Û	Ü	ß	à	á	â	ã	ä	å	æ	ç																																																																																																																																																																														
	è	é	ê	ë	ì	í	î	ï	ò	ó	ô	õ	ö	ø	ù	ú	û	ü																																																																																																																																																																														
	ý	ÿ	ı	ı	ı	ı	ı	ı	ı	ı	ı	ı	ı	ı	ı	ı	ı	ı																																																																																																																																																																														
	0	1	2	3	4	5	6	7	8	9	%	.	,																																																																																																																																																																																			
	?	!	(	)	[	]	<	>	=	/	+	-																																																																																																																																																																																				
	█ Lab Balance																																																																																																																																																																																															
Accept	Escape	Delete Letter	Cursor Left	Cursor Right																																																																																																																																																																																												

### 3.13.2. BAUD RATE

Option: 4800, 9600, 19200, 38400

Set the serial communication baud rate.

Balance Configuration				
Select the option to be modified.				
Balance Name:	Lab Balance			
Baud Rate:	9600			
Data Bit:	8 bits			
Parity:	N			
Stop Bit:	1			
Request Command:				
<div style="border: 1px solid black; padding: 2px; display: inline-block;">           4800  <b>9600</b>            19200            38400         </div>				
Select	Escape		Test Balance	

### 3.13.3. DATA BITS

Option: 5, 6, 7, 8 bits

Set the number of data bits.

Balance Configuration				
Select the option to be modified.				
Balance Name:	Lab Balance			
Baud Rate:	9600			
Data Bit:	8 bits			
Parity:	N			
Stop Bit:	1			
Request Command:				
<div style="border: 1px solid black; padding: 2px; display: inline-block;">           5 bits            6 bits            7 bits  <b>8 bits</b> </div>				
Select	Escape		Test Balance	

### 3.13.4. PARITY

Option: No Parity, Even, Odd

Set the parity of data packet.

Balance Configuration				
Select the option to be modified.				
Balance Name:	Lab Balance			
Baud Rate:	9600			
Data Bit:	8 bits			
Parity:	No Parity			
Stop Bit:	1 bit			
Request Command:	Request			
				<div style="border: 1px solid black; padding: 2px;">           No Parity            Even            Odd         </div>
Select	Escape		Test Balance	

### 3.13.5. STOP BIT

Option: 1 bit or 2 bits

Set the number of stop bits.

Balance Configuration				
Select the option to be modified.				
Balance Name:	Lab Balance			
Baud Rate:	9600			
Data Bit:	8 bits			
Parity:	No Parity			
Stop Bit:	1 bit			
Request Command:	Request			
				<div style="border: 1px solid black; padding: 2px;">           1 bit            2 bits         </div>
Select	Escape		Test Balance	

### 3.13.6. EDIT REQUEST STOP

Option: Up to 10 characters

Type the syntax for weight request command.

Request Command

Select the highlighted letter by using the arrow keys then press "Enter".  
Select the empty field for a space.  
Press Accept to save the entered text.

█	A	B	C	D	E	F	G	H	I	J	K	L
M	N	O	P	Q	R	S	T	U	V	W	X	Y
Z	a	b	c	d	e	f	g	h	i	j	k	l
m	n	o	p	q	r	s	t	u	v	w	x	y
z	À	Á	Â	Ã	Ä	Å	Ç	È	É	Ê	Ë	Ì
Í	Î	Ï	Ñ	Ò	Ó	Ô	Õ	Ö	Ø	Ù	Ú	Û
Ü	Ý	à	á	â	ã	ä	å	æ	ç	è	é	ê
ë	ì	í	î	ï	ñ	ó	ô	õ	ö	ø	ù	ú
û	ü	ý	ÿ	ı	*	\	_	\$	'	^	#	:
0	1	2	3	4	5	6	7	8	9	%	.	,
?	!	(	)	[	]	<	>	=	/	+	-	

█ command █

Accept	Escape	Delete Letter	Cursor Left	Cursor Right
--------	--------	---------------	-------------	--------------

### 3.14. PRINTER MODE

Option: Ansi, Ascii, Text

General Options

Select the option to be modified.

Temperature:	°C, ATC
Date and Time Setting	
Display Settings	
Beeper:	Off
Stirrer:	Enabled
Language:	English
Titrant 1 Volume Alert:	1000.0 mL
Titrant 1 Age Reminder:	
Titrant 2 Volume Alert:	
Titrant 2 Age Reminder:	
USB Link with PC	
Setup Balance Interface	
Printer Mode:	Ansi

Select	Escape			
--------	--------	--	--	--

**Ansi** Use this mode when the printer is set as Ansi. When in this mode, all available accented characters and symbols will be printed.

**Ascii** Use this mode when the printer is set as Ascii. When in this mode, only some of the available accented characters and symbols will be printed.

**Text** This mode is recommended when the user doesn't need to print accented characters.

### 3.15. RESET TO DEFAULT SETTINGS

**Note:** This will delete all user-defined methods and restore all manufacturer settings such as titrator configuration, standard method parameters, etc.



### 3.16. OPTIMIZE MEMORY SPACE

This screen allows the user to run a memory defragmentation utility to increase access speed to memory storage. Press

and then restart the titrator. Do not disconnect the power supply during this operation.

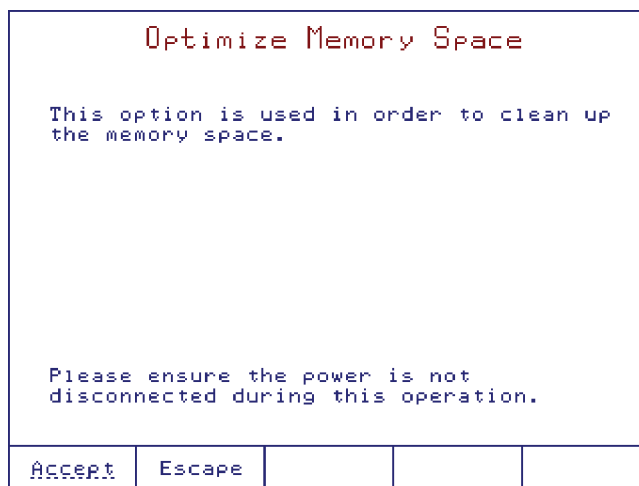

### 3.17. UPDATE SOFTWARE

This screen allows the user to update the titrator software from a USB storage device containing a software setup kit.

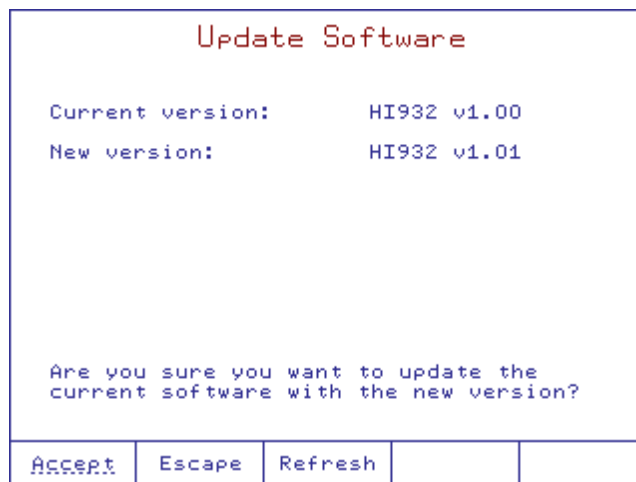

To update the software:

1. Copy the “**Setup932**” folder to a USB storage device.
2. Insert the USB storage device into the USB port.
3. Go to **General Options**, then **Update Software**. The titrator will display the current and new software versions.
4. Press . When prompted, remove the USB storage device and restart the titrator.

## 4. TITRATION METHODS

All parameters required to complete an analysis are grouped into a method.

The titrator is supplied with a pack of standard methods, these methods have been developed by Hanna Instruments and can be used to create user-defined methods.

Standard and user-defined methods can be upgraded, saved or deleted by connecting the titrator to a PC using the **HI900** PC application or a USB flash drive.

### 4.1. SELECTING METHODS

To select a method, press  from the main screen. A list of available methods will be displayed.

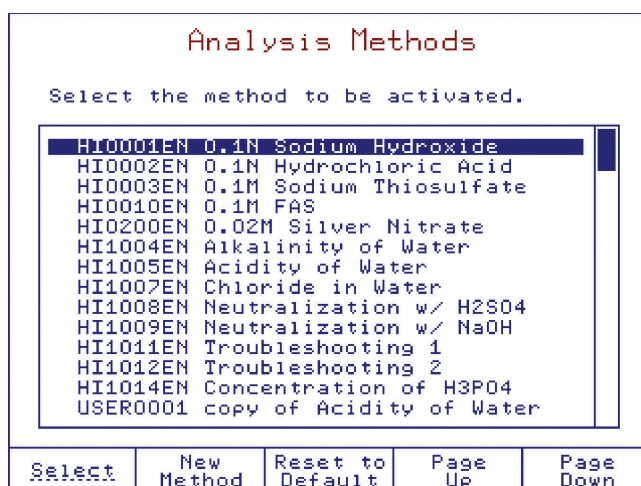

In the **Analysis Methods** screen, you can view the list of all available methods (standard and user-defined methods).

To select a method, highlight the method then press . The name of the selected method will be displayed on the main screen.

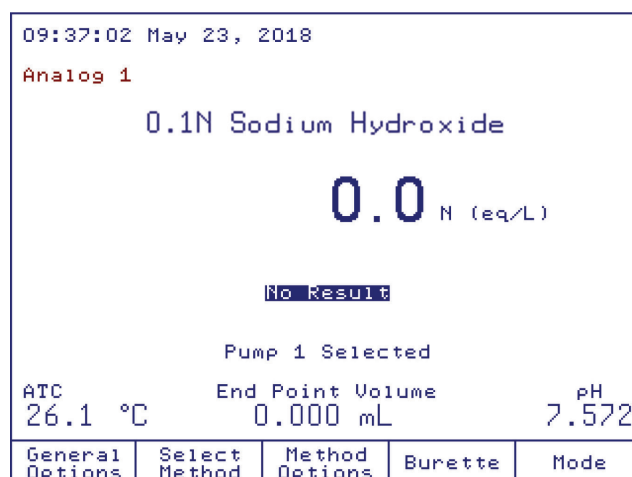

### 4.2. STANDARD METHODS

The standard methods are developed for the most common types of analysis and can be used as templates to create new user-defined methods.

Only specific method parameters can be modified by the user. See **4.5. METHOD OPTIONS** section for more information.

#### 4.2.1. UPGRADING STANDARD METHODS

To upgrade the titrator with new standard methods, follow the steps below:

**From USB storage device:**

1. Insert the USB storage device into the USB port, located on the right side of the titrator.
2. Press **General Options** from the main screen.
3. Using **▲** and **▼** keys, highlight *Restore from USB Storage Device* option and choose **Select**.
4. Using **<** and **>** keys, navigate through file types to find "standard method files".
5. Press the **Copy File** or **Copy All** key to upgrade the titrator with the standard methods.
6. Press **Escape** to return to **General Options** screen.

**From PC:**

You can upgrade the titrator with standard methods from a PC using the **HI900** PC application. See **3.12. USB LINK WITH PC** section for more information.

#### 4.2.2. DELETING STANDARD METHODS

Standard methods can be removed from the titrator by following one of the procedures below.

**From General Options Screen:**

1. Using the **▲** and **▼** keys, highlight *Save to USB* option and press **Select**.
2. Using the **<** and **>** keys, navigate through the file types menu to find the list of "standard method files".
3. Press the **Delete** or **Delete All** keys to remove unnecessary standard methods.
4. Press **Escape** to return to the **General Options** screen.

**From PC:**

The not required standard methods can be removed from the titrator using the **HI900** PC application. See **3.12. USB LINK WITH PC** section for more information.

#### 4.2.3. RESTORING THE STANDARD METHODS TO THE MANUFACTURER SETTINGS

You can restore the standard methods to the default settings by highlighting a standard method and pressing **Reset to Default**.

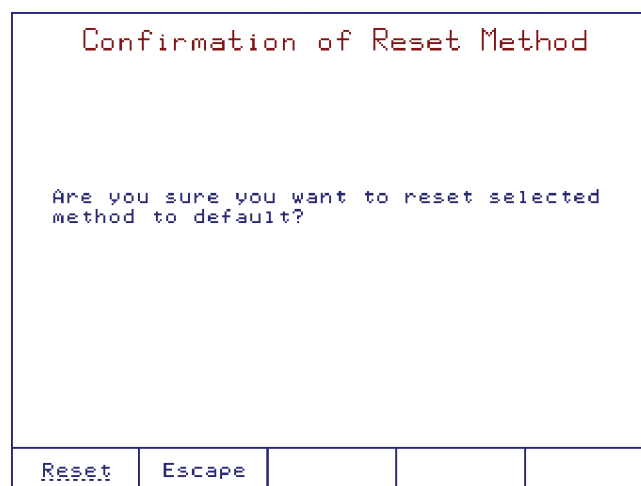







### 4.3. USER-DEFINED METHODS

User-defined methods are created by users, by modifying a standard method or previously created user-defined method. All method parameters can be modified to suit user-specific requirements.

#### 4.3.1. CREATING USER-DEFINED METHODS



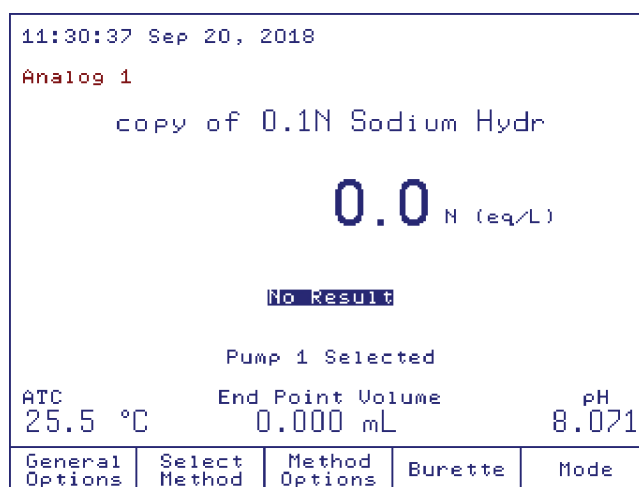

To create a new user-defined method, start from a standard or previously generated user-defined method and follow these steps:

1. Press  from the main screen.
2. Using the  and  keys, highlight an existing method from the method list.
3. Press . A new user-defined method will be generated.
4. Press  to activate the new method.



**Note:** The titrator can hold 100 methods (standard and user-defined). When the limit is reached, a warning message is displayed.

#### 4.3.2. DELETING USER-DEFINED METHODS

1. To remove a user-defined method, press  from the main screen.
2. Highlight the user-defined method that you want to delete and press , a confirmation screen will appear.
3. Press  again to confirm, or press  to cancel the operation.

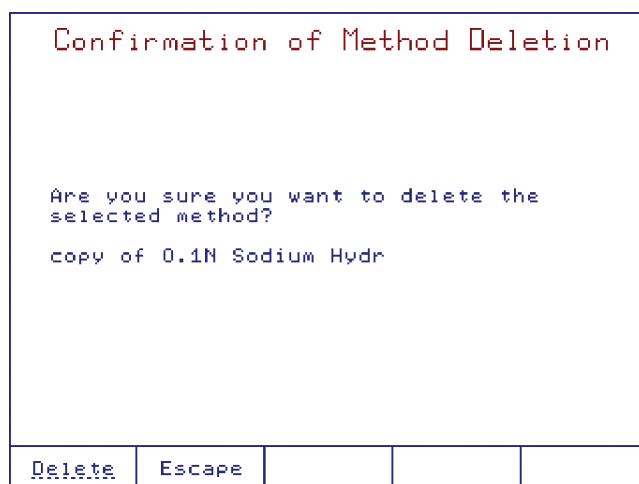

#### 4.4. VIEWING / MODIFYING METHOD

To modify the method parameters, press Method Options from the main screen. A list of all the parameters for the selected method will be displayed. Press the ▲ and ▼ keys to highlight the option you want to modify and choose Select.

View/Modify Method				
Id: USER0008		Modified: 17:55 Sep 12, 2018		
Select the option to be modified.				
<pre> Name: copy of 0.1N Sodium Hydr Method Revision: 1.0 Analysis Type: Standard Titration Analog Board: Analog 1 Stirrer Configuration Titrant pump: Pump 1 Reagent Addition 1: Disabled Reagent Addition 2: Disabled Dosing Type: Dynamic End Point Mode: pH 1EQ point,1st Der Recognition Options Pre-Titration Volume: 5.000 mL Pre-Titration Stir Time: 60 sec Measurement Mode: Signal Stability           </pre>				
Select	Escape	Print Method	Page Up	Page Down

To exit the **View / Modify Method** screen, press the Escape key and highlight *Save Method* or *Exit Without Saving Method*.

Saving Method				
Select a menu option.				
<pre> Save Method Exit Without Saving Method           </pre>				
"Escape" - exits without saving method.				
Select	Escape			

Select Saves modifications.

Escape Discards the changes.

## 4.5. METHOD OPTIONS

*Note: Not all method options can be changed for standard methods.*

### 4.5.1. NAME

Option: Up to 24 characters

Method Name				
Select the highlighted letter by using the arrow keys then press "Enter". Select the empty field for a space. Press Accept to save the entire name.				
<pre> A B C D E F G H I J K L M N O P Q R S T U V W X Y Z a b c d e f g h i j k l m n o p q r s t u v w x y Z A A Å Å Ä Ç È É Ê Ë Ì Í Î Ï Ñ O O O Ø Ù Ú Û Ü Õ Ö à á â ã ä å ç è é ê ë ì í ñ ò ó ô õ ö ø ù ú û ü ý ÿ \ _ ` ^ # : 0 1 2 3 4 5 6 7 8 9 % ' , . ? ! ( ) [ ] &lt; &gt; = / + - </pre>				
copy of 0.1N Sodium Hydr				
Accept	Escape	Delete Letter	Cursor Left	Cursor Right

### 4.5.2. METHOD REVISION

Option: Up to 3 characters

Method Revision				
Select the highlighted letter by using the arrow keys then press <Enter>. Select the empty field for a space. The revision string format is "X.X".				
<pre> B C D E F G H I J K L M N O P Q R S T U V W X Y Z a b c d e f g h i j k l m n o p q r s t u v w x y z A A Å Å Ä Ç È É Ê Ë Ì Í Î Ï Ñ O Ø Ù Ú Û Ü Õ Ö à á â ã ä å ç è é ê ë ì í ñ ò ó ô õ ö ø ù ú û ü ý ÿ \ _ ` ^ # : 0 1 2 3 4 5 6 7 8 9 % ' , . * / \ _ ` ^ # : </pre>				
1.0				
Accept	Escape	Delete Letter	Cursor Left	Cursor Right

### 4.5.3. ANALYSIS TYPE

Option: Standard Titration, Back Titration, Direct Reading

Analysis Type				
Select the analysis type.				
<div style="border: 1px solid black; padding: 2px;">           Standard Titration            Back Titration            Direct Reading         </div>				
Select	Escape			

#### 4.5.3.1. Standard Titration

- A titration with a pH or mV equivalence point detection (single or multiple equivalence points).
- A titration with fixed pH or mV endpoint.
- A titrant standardization.

#### 4.5.3.2. Back Titration

A titration with a pH or mV equivalence point detection consisting of two titration phases:

- Phase 1 – the sample is consumed by a known volume and concentration of titrant 1. A sufficient amount of titrant 1 is dispensed to surpass the equivalence point in order to react quickly with the sample.
- Phase 2 – the excess of titrant 1 is titrated with the titrant 2 to the equivalence point. The concentration of the sample is determined by the amount of titrant used in phase 2.

#### Break At Titrant Changing

Option: Yes or No

Select Yes to stop the titration temporarily between the titration phases, this allows users to perform a task related to the analysis (e. g. boiling the sample to remove carbon dioxide, pH adjustment, etc.)

Break at Titrant Changing				
Select the option.				
<div style="border: 1px solid black; padding: 2px;">           NO            YES         </div>				
"NO" - without break at titrant changing. "YES" - with break at titrant changing.				
Select	Escape			

### 4.5.3.3. Direct Reading

A direct pH, mV or ISE reading with an optional reagent addition. The titrator will take the measurement automatically once a stable reading has been obtained.

### 4.5.4. ANALOG BOARD

Option: Analog 1 or Analog 2 (if installed)

View/Modify Method				
Id: USER0003      Modified: 09:40 May 23, 2018				
Select the option to be modified.				
Name:            copy of 0.1N Sodium Hydr				
Method Revision:            1.0				
Analysis Type:            Standard Titration				
Analog Board:            Analog 1				
Stirrer Configuration				
Titrant 1 pump:            Analog 1				
Titrant 2 pump:            Analog 2				
Reagent Addition 1:				
Reagent Addition 2:            Disabled				
Dosing Type:            Dynamic				
End Point Mode:    pH 1EQ point,1st Der				
Recognition Options				
Pre-Titration Volume:            5.000 mL				
Pre-Titration Stir Time:            60 sec				
Select	Escape	Print Method	Page Up	Page Down

### 4.5.5. STIRRER CONFIGURATION

Use the arrow keys to select the menu option.

Stirrer Configuration				
Select a menu option.				
Stirrer:                            Stirrer 1				
Stirring Speed:                    1400 RPM				
Select	Escape			

## 4.5.5.1. Stirrer

Option: Stirrer 1, Stirrer 2 (if available), Disabled

The screenshot shows a terminal window titled "Stirrer Configuration". The prompt "Select a menu option." is displayed. A menu is open with "Stirrer:" selected, and a sub-menu is visible with options "Disabled", "Stirrer 1", and "Stirrer 2". At the bottom of the window, there are five buttons: "Select", "Escape", and three empty buttons.

## 4.5.5.2. Stirrer Speed

Option: 200 to 2500 RPM

The screenshot shows a terminal window titled "Stirring Speed". The prompt "Enter the speed of the stirrer within below range." is displayed. The current speed is shown as "1400 RPM". Below this, it says "The range is from 200 to 2500 RPM." At the bottom of the window, there are five buttons: "Accept", "Escape", "Delete Digit", and two empty buttons.

The stirrer will remain on for as long as the method is active. When the stirrer is running, the speed can be adjusted at any time by using the  $\Delta$  and  $\nabla$  keys.

#### 4.5.6. PUMP CONFIGURATION

Option: Pump 1, Pump 2 (if installed)

*Note: For back titrations, the pump for titrant 1 and titrant 2 need to be selected.*

View/Modify Method				
Id: USER0003      Modified: 09:40 May 23, 2018				
Select the option to be modified.				
Name:                    copy of 0.1N Sodium Hydr				
Method Revision:                    1.0				
Analysis Type:                    Standard Titration				
Analog Board:                    Analog 1				
Stirrer Configuration				
Titrant 1 pump:                    Pump 1				
Titrant 2 pump:				
Reagent Addition 1:                    Pump 1				
Reagent Addition 2:                    Pump 2				
Dosing Type:				
End Point Mode:                    pH 1EQ point,1st Der				
Recognition Options				
Pre-Titration Volume:                    5.000 mL				
Pre-Titration Stir Time:                    60 sec				
Select	Escape	Print Method	Page Up	Page Down

#### 4.5.7. REAGENT ADDITION

Option: Burette, Peristaltic Pump, Disabled

Reagent Addition 1				
Select the option to be modified.				
Reagent Pump:                    Disabled				
Disabled				
Burette 1				
Peristaltic 1				
Burette 2				
Peristaltic 2				
Select	Escape			

## 4.5.7.1. Burette (Volume Addition)

Use the numeric keypad to enter the volume to be dispensed.

<b>Addition Volume</b>				
Enter the addition reagent volume to be added to the sample.				
5.000 mL				
Press Help to view the valid ranges for the addition volume.				
Accept	Escape	Delete Digit		

The volume dispensed must be between the limits shown below:

5 mL burette	0.001 to 4.750 mL
10 mL burette	0.001 to 9.500 mL
25 mL burette	0.005 to 23.750 mL
50 mL burette	0.005 to 47.500 mL

## 4.5.7.2. Peristaltic Pump (Time Addition)

Option: 0 to 1800 seconds

Enter the dispensing time required to add the desired amount of reagent.

*Note: The user should determine this value experimentally. The approximate dispensing rate is 200 mL per min.*

<b>Dispensing Time</b>				
Enter the period of time for running auxiliary pump.				
5 sec				
Low limit: 0 second High limit: 1800 seconds				
Accept	Escape	Delete Digit		



### 4.5.7.3. Stirring Time

Option: 0 to 1800 seconds

The timer will start after the reagent has been added.

<b>Stirring Time</b>				
Please enter the stirring time in seconds.				
██████████ 8 sec				
Low limit: 0 second High limit: 1800 seconds				
Accept	Escape	Delete Digit		

### 4.5.7.4. Waiting Time

Option: 0 to 1800 seconds

The timer will start after the stirring timer.

<b>Wait Time</b>				
Please enter the wait time in seconds.				
██████████ 2 sec				
Low limit: 0 second High limit: 1800 seconds				
Accept	Escape	Delete Digit		

#### 4.5.8. MEASUREMENT PARAMETER (DIRECT READING ONLY)

Option: pH, ISE, mV

Select the measurement parameter for the direct reading. Setup screen for the selected parameter is visible in the method options.

View/Modify Method																																																											
Id: USER0002      Modified: 16:11 Nov 26, 2019																																																											
Select the option to be modified.																																																											
<table border="1"> <tr> <td>Name:</td> <td>copy of 0.1N Sodium Hydr</td> <td></td> <td></td> <td></td> </tr> <tr> <td>Method Revision:</td> <td></td> <td></td> <td></td> <td>1.0</td> </tr> <tr> <td>Analysis Type:</td> <td>Direct Re</td> <td></td> <td></td> <td></td> </tr> <tr> <td>Analogue Board:</td> <td>Anal</td> <td></td> <td></td> <td>pH</td> </tr> <tr> <td>Stirrer Configuration</td> <td></td> <td></td> <td></td> <td>mV</td> </tr> <tr> <td>Reagent Addition 1:</td> <td>Dis</td> <td></td> <td></td> <td>ISE</td> </tr> <tr> <td>Reagent Addition 2:</td> <td>Dis</td> <td></td> <td></td> <td></td> </tr> <tr> <td>Measurement Parameter:</td> <td></td> <td></td> <td></td> <td>pH</td> </tr> <tr> <td>Electrode Type:</td> <td></td> <td></td> <td></td> <td>pH</td> </tr> <tr> <td>Linked To:</td> <td>No Link</td> <td></td> <td></td> <td></td> </tr> <tr> <td colspan="5">pH Setup</td> </tr> </table>					Name:	copy of 0.1N Sodium Hydr				Method Revision:				1.0	Analysis Type:	Direct Re				Analogue Board:	Anal			pH	Stirrer Configuration				mV	Reagent Addition 1:	Dis			ISE	Reagent Addition 2:	Dis				Measurement Parameter:				pH	Electrode Type:				pH	Linked To:	No Link				pH Setup				
Name:	copy of 0.1N Sodium Hydr																																																										
Method Revision:				1.0																																																							
Analysis Type:	Direct Re																																																										
Analogue Board:	Anal			pH																																																							
Stirrer Configuration				mV																																																							
Reagent Addition 1:	Dis			ISE																																																							
Reagent Addition 2:	Dis																																																										
Measurement Parameter:				pH																																																							
Electrode Type:				pH																																																							
Linked To:	No Link																																																										
pH Setup																																																											
Select	Escape	Print Method	Page Up	Page Down																																																							

#### 4.5.9. DOSING TYPE

Option: Linear Dosing or Dynamic Dosing

Dosing Type														
Select the dosing type.														
<table border="1"> <tr> <td>Linear Dosing</td> <td></td> <td></td> <td></td> <td></td> </tr> <tr> <td>Dynamic Dosing</td> <td></td> <td></td> <td></td> <td></td> </tr> </table>					Linear Dosing					Dynamic Dosing				
Linear Dosing														
Dynamic Dosing														
Select	Escape													

### 4.5.9.1. Linear Dosing

Linear dosing dispenses a pre-defined volume of titrant with every addition.

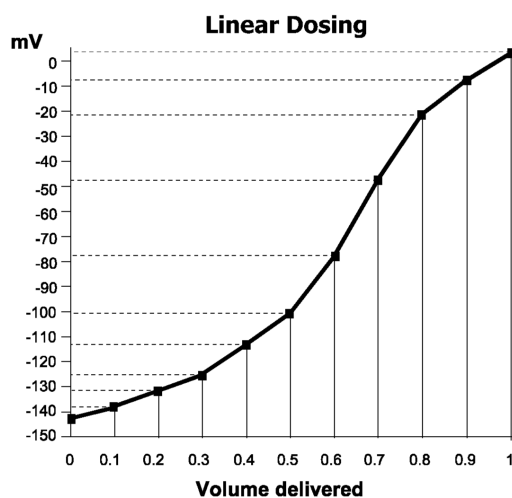

Linear dosing is recommended for titrations with a slower reaction rate, difficult nonaqueous titrations, and specific applications.

**Note:** For steep and normal titration curves, smaller volume increments are recommended, to obtain many points around the equivalence point. For flat titration curves, larger volume increments are recommended for equivalence point detection.

To set the dosing volume, select Linear Dosing and enter the optimum dose.

Dosing volume ranges are:

5 mL burette	0.001 to 4.750 mL
10 mL burette	0.001 to 9.500 mL
25 mL burette	0.005 to 23.750 mL
50 mL burette	0.005 to 47.500 mL

### 4.5.9.2. Dynamic Dosing

The titrator determines the titrant dose by trying to maintain a certain potential change ( $\Delta E$ ) with each addition. After a titrant dose, if the potential change is lower than the set  $\Delta E$ , the next dose will be progressively increased until  $max Vol$  is attained. If the potential change is still lower than the set value, the titration will continue with  $max Vol$  doses. After a titrant dose, if the potential change is higher than the set  $\Delta E$ , the next dose will be progressively decreased until  $min Vol$  is attained. If the potential change is still higher than the set value, the titration will continue with  $min Vol$  doses. The titrant is added in volumes that depend on the proximity of the endpoint as shown in the graph below.

Dynamic dosing allows for larger doses far from the endpoint, reducing the total titration time. Closer to the endpoint, smaller doses are made, providing more data and improved accuracy.

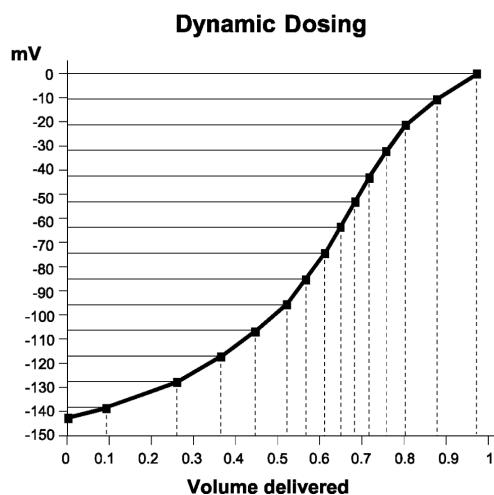

Dynamic Dosing

Enter min Vol, max Vol and delta E.

0.030 mL - min Vol

0.500 mL - max Vol

4.500 mV - delta E

Press Next to move to the next entry.

Accept	Escape	Delete Digit	Next	
--------	--------	--------------	------	--

The following parameters must be set:

**min Vol** The smallest dose to be dispensed during a titration.

The *min Vol* must be greater than or equal to:

5 mL & 10 mL burette      0.001 mL

25 mL & 50 mL burette    0.005 mL

**max Vol** The largest dose to be dispensed during a titration.

The *max Vol* must be less than or equal to 4.000 mL.

**delta E** Sets the fixed potential jump that has to be achieved after each titrant dose.

The allowed range is between 0.1 and 99.999 mV.

#### Recommendations for dosing parameters:

For steep and normal titration curves the recommended settings are:

**delta E**      3.5 to 9 mV

**min Vol**      0.010 to 0.025 mL (25 mL burette)

**max Vol**      0.075 to 0.250 mL (25 mL burette)

For flat titration curves the recommended settings are:

**delta E**      10 to 15 mV

**min Vol**      0.050 to 0.150 mL (25 mL burette)

**max Vol**      0.400 to 0.600 mL (25 mL burette)

To achieve the highest levels of accuracy and reproducibility, it is recommended that 20 to 80% of the nominal burette volume used for each titration is consumed. If lower volumes of titrant are required, a smaller burette can be used.

#### 4.5.10. ENDPOINT MODE

Option: Equivalence Endpoint (pH or mV) or Fixed Endpoint (pH or mV)

Titration End Point Mode								
Select the end point detection.								
<table border="1"> <tbody> <tr> <td>Equivalence End Point (pH)</td> </tr> <tr> <td>Equivalence End Point (mV)</td> </tr> <tr> <td>Fixed End Point (pH)</td> </tr> <tr> <td>Fixed End Point (mV)</td> </tr> </tbody> </table>					Equivalence End Point (pH)	Equivalence End Point (mV)	Fixed End Point (pH)	Fixed End Point (mV)
Equivalence End Point (pH)								
Equivalence End Point (mV)								
Fixed End Point (pH)								
Fixed End Point (mV)								
Select	Escape							

##### 4.5.10.1. Fixed Endpoint (pH or mV)

Fixed Endpoint (pH)

Option: -2.000 to 20.000 pH

The titration is terminated when the preset pH value has been exceeded. The endpoint volume is a calculated value based on the dispensed volume when pH is under the preset value and the dispensed volume when pH exceeds the preset value.

Preset pH End Point						
Enter the end point pH value.						
<table border="1"> <tbody> <tr> <td>8.600</td> <td>pH</td> </tr> </tbody> </table>					8.600	pH
8.600	pH					
The range is from -2.000 to 20.000 pH.						
Accept	Escape	Delete Digit				

**Fixed Endpoint (mV)**

Option: -2000.0 to 2000.0 mV

The endpoint detection algorithm is the same as for pH, but the threshold value is expressed in mV.

Preset mV End Point				
Enter the end point mV value.				
0.0 mV				
The range is from -2000.0 to 2000.0 mV.				
Accept	Escape	Delete Digit		

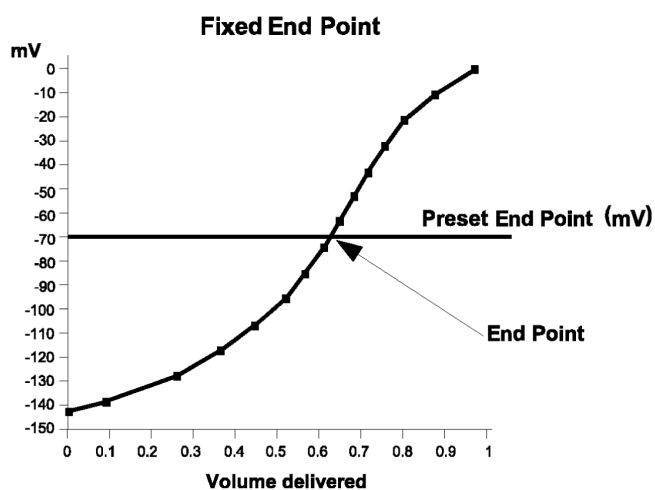
**4.5.10.2. Equivalence Endpoint (pH or mV)**

The titration is terminated when the equivalence point is detected (the point where the added quantity of titrant equals the quantity of analyte present in the sample).

**Number of Equivalence Points**

Option: 1 to 5

Number of Equivalence Points				
Enter the number of equivalence points to be found.				
3 points				
The range is between 1 and 5 equivalence points.				
Accept	Escape	Delete Digit		

## Endpoint Determination

Option: 1<sup>st</sup> derivative or 2<sup>nd</sup> derivative

End Point Determination

Select the end point determination.

1st derivative  
 2nd derivative

Select
Escape

The equivalence point detection algorithm requires three additional titrant doses to be dispensed after the equivalence point is reached.

The reported endpoint volume is a calculated value based on a number of points around the equivalence point.

The potentiometric titration curve is the response in mV potential, or pH, between the indication of the electrode versus the volume of titrant added.

The inflection point of the titration curve is assumed to be the equivalence point of the chemical reaction.

For non-symmetric titration curves, the theoretical error can be reduced by using the dynamic dosing.

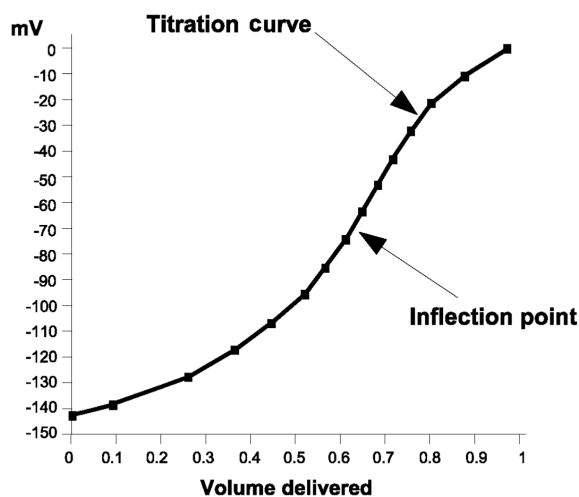

### 1<sup>st</sup> Derivative

When 1<sup>st</sup> derivative is used to recognize the equivalence point, the titration curve inflection point (EQP) is the point where the 1<sup>st</sup> derivative reaches its maximum value.

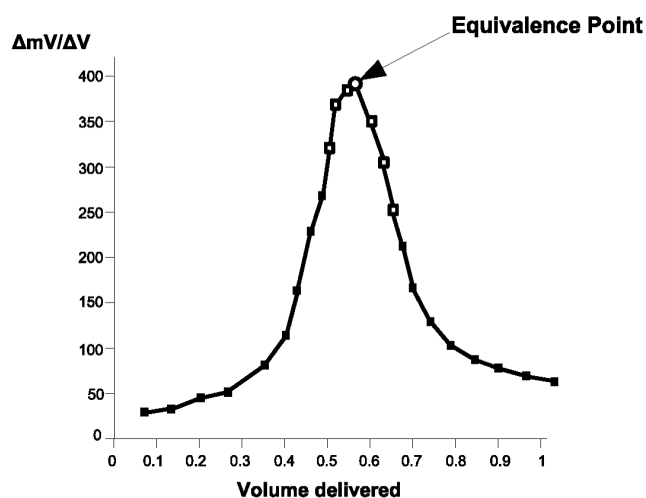

The detection algorithm looks for the maximum value of the 1<sup>st</sup> derivative. The 1<sup>st</sup> derivative must be greater than the threshold value at the maximum point. See [4.5.11. RECOGNITION OPTIONS \(EQUIVALENCE ENDPOINT ONLY\)](#) section for more information.

### 2<sup>nd</sup> Derivative

When 2<sup>nd</sup> derivative is used to recognize the equivalence point, the titration curve inflection point (EQP) is the point where the second derivative crosses zero.

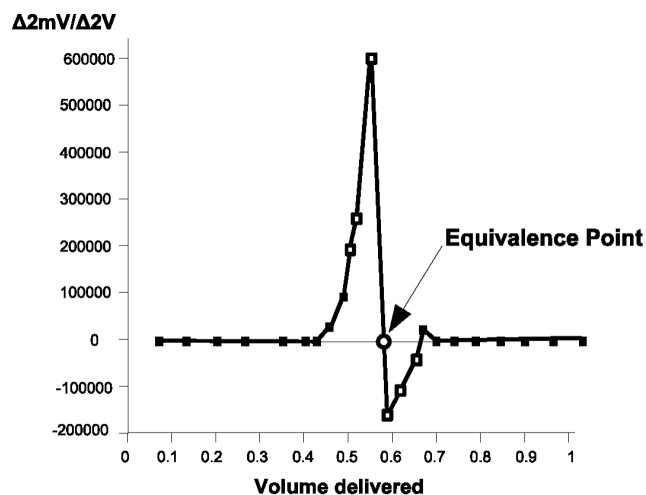

The detection algorithm looks for the point where the second derivative changes sign.

The checked point, or 1<sup>st</sup> derivative, must be greater than the threshold value. See [4.5.11. RECOGNITION OPTIONS \(EQUIVALENCE ENDPOINT ONLY\)](#) section for more information.



#### 4.5.11. RECOGNITION OPTIONS (EQUIVALENCE ENDPOINT ONLY)

The **Recognition Options** screen is a set of parameters used to avoid false detection of the equivalence point due to the chemical system (titrant / sample species and concentrations) and / or electrode response.

Recognition Options	
Select the options for equivalence point recognition.	
Threshold	500 mV/mL
Range	NO
Filtered Derivatives	NO
Select	Escape

##### 4.5.11.1. Threshold

**Option: 1 to 9999 mV / mL**

This parameter must be set by the user according to the analysis.

The threshold represents the absolute value of the 1<sup>st</sup> derivative, expressed in mV / mL, which the detection algorithm does not search for the equivalence point.

Threshold			
Enter the threshold for equivalence point detection.			
EQ 1 Threshold: 500 mV/mL			
Recommended value is between: 1 and 450 mV/mL for FLAT Curve, 450 and 1800 mV/mL for NORMAL Curve, 1800 and 9999 mV/mL for STEEP Curve.			
Accept	Escape	Delete Digit	Next Threshold

The recommended value is 40% of the absolute value of the 1<sup>st</sup> derivative.

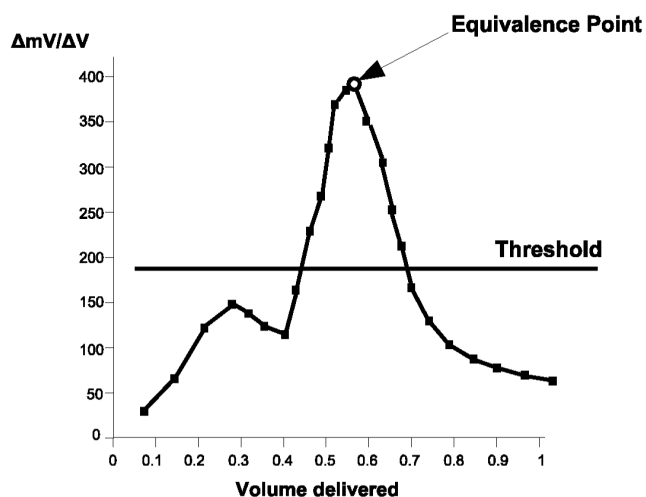

Depending on the titration curve profile, the following guide can be used:

Flat	1 to 450
Normal	50 to 1800
Steep	1800 to 9999

#### 4.5.11.2. Range

Option: -2.000 to 20.000 pH or -2000.0 to 2000.0 mV

Range is an optional feature for equivalence point recognition.

Select Yes in the Range Options screen to enable.

The titrator will only look for an equivalence point between the set values.

Range Limits

Enter Limit 1 and Limit 2 for range.

-2.0 mV - EQ 1 Limit1

20 mV - EQ 1 Limit2

Press <Next EQ Range> for the next range.

Accept	Escape	Delete Digit	Next Limit	Next EQ Range
--------	--------	-----------------	---------------	------------------

The Limit 2 value must not be equal to the Limit 1 value.

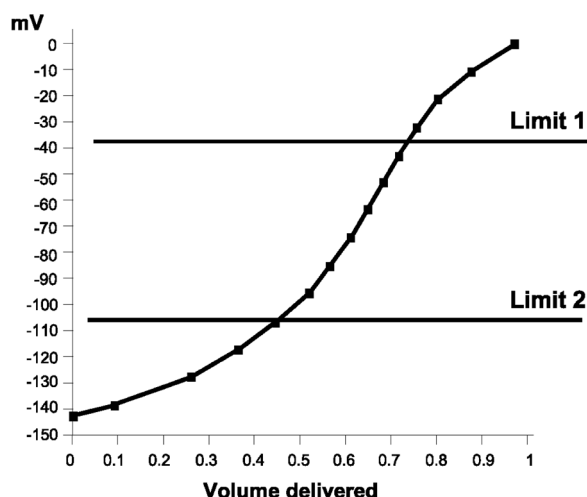

#### 4.5.11.3. Filtered Derivatives

**Option: Yes or No**

This option adds a filtering procedure in the 1<sup>st</sup> and 2<sup>nd</sup> derivative computation algorithm that reduces the influence of pH or mV noise.

Select Yes in the Filtered Derivative Option to enable.

Filtered Derivatives Option

Select option for filtered derivatives.

NO

YES

"NO" - without filtered derivatives.  
"YES" - with filtered derivatives.

Select	Escape			
--------	--------	--	--	--

Noise can be due to:

- Chemical system properties (sample, titrant, solvent), such as slow chemical reactions or unbuffered samples such as wastewater, tap water, wine
- Electrode response
- Incorrect method parameters settings such as *Signal Stability*, *Stirring Speed*, etc.
- Insufficient titrant additions

**Note:** A shift in the endpoint volume by 1 or 2 doses may be seen due to filtering.

#### 4.5.12. PRE-TITRATION VOLUME

During a titration, the equivalence point is reached after many titrant doses. These doses take up extra time while having no relevance for equivalence point detection.

Pre-titration volume adds a large initial dose to jump directly to the proximity of the equivalence point.

This first dose occurs after the pre-titration stir time is completed.

The ranges for pre-titration volumes are shown below:

5 mL burette	0.001 to 4.750 mL
10 mL burette	0.001 to 9.500 mL
25 mL burette	0.005 to 23.750 mL
50 mL burette	0.005 to 47.500 mL

Pre-Titration Volume				
Enter the initial titrant volume to be dispensed.				
9.000 mL				
Press Help to view the valid ranges for the pre-titration volume.				
Accept	Escape	Delete Digit		

To disable a pre-titration volume, enter 0.000 mL.

**Note:** A pre-titration volume is highly recommended whenever possible. Fewer doses will considerably shorten the overall titration duration.

#### 4.5.13. PRE-TITRATION STIR TIME

Option: 0 to 180 seconds

When enabled, the sample is mixed for a set period of time before any titrant is added. This allows the sample to become homogeneous.

Pre-Titration Stir Time				
Enter the initial mixing time prior to the start of the titration.				
10 seconds				
The range is from 0 to 180 seconds.				
Accept	Escape	Delete Digit		

Pre-titration stir time is disabled if 0 seconds is entered.

#### 4.5.14. MEASUREMENT MODE

Option: *Signal Stability* or *Timed Increment*

During titration, the acquisition of the potential (mV) value of the solution can be done by using either *Signal Stability* or *Timed Increment* option.

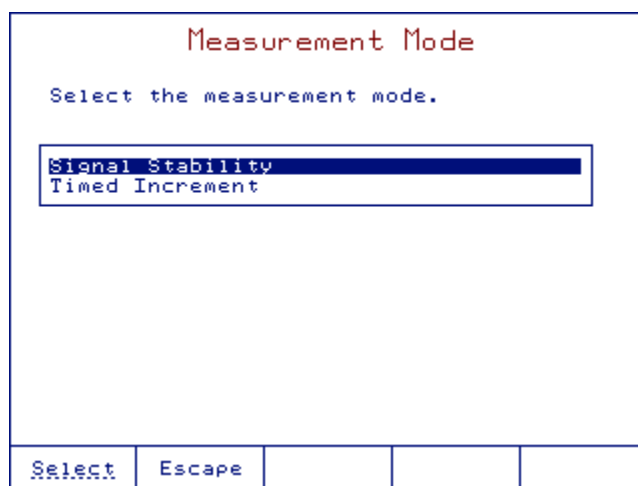

##### 4.5.14.1. Signal Stability

When *Signal Stability* is selected, the titrator acquires the potential (mV) only when stable conditions are reached.

The principles of signal stability are plotted below:

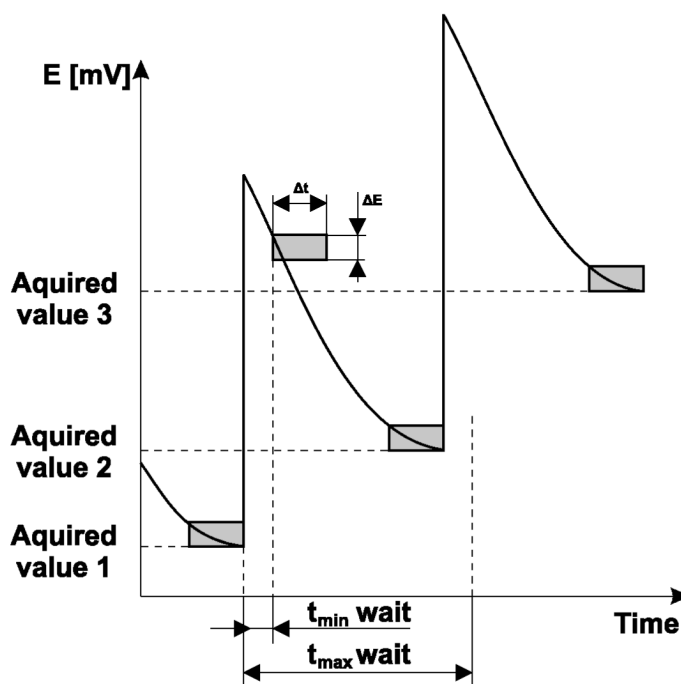

The signal stability window (condition) represents the time interval ( $\Delta t$ ) during which the potential measured in solution (mV) is confined inside the potential interval ( $\Delta E$ ).

The new signal value is acquired if the stability condition is reached after the minimum ( $t_{\min}$ ) wait time.

If the stability condition is not reached and the maximum ( $t_{\max}$ ) wait time has elapsed, the potential is acquired.

Signal Stability				
Enter mV variation ( $\Delta E$ ) in the time interval ( $\Delta t$ ) min and max wait time period to the next sample measurement.				
0.3 mV		- $\Delta E$		
2 seconds		- $\Delta t$		
3 seconds		- $t_{\min \text{ wait}}$		
30 seconds		- $t_{\max \text{ wait}}$		
Accept	Escape	Delete Digit	Next	

- $\Delta E$**  Maximum change in potential during  $\Delta t$   
The range is from 0.1 to 99.9 mV.
- $\Delta t$**  The time interval during which the potential is measured.  
The range is from 1 to 10 seconds.
- $t_{\min \text{ wait}}$**  The minimum elapsed time before a stability check. This is also the minimum elapsed time between two doses.  
The range is from 2 seconds to  $t_{\max \text{ wait}}$  time.
- $t_{\max \text{ wait}}$**  The maximum elapsed time between two successive doses. If the  $t_{\max \text{ wait}}$  has elapsed, a new dose is added even if the signal stability condition is not reached.  
The range is from  $t_{\min \text{ wait}}$  time to 180 seconds.

#### 4.5.14.2. Timed Increment

##### Option: 2 to 180 seconds

When *Timed Increment* is selected, the titrator acquires the potential (mV) at a fixed time interval (no signal stability check).

The time period between two acquisitions must be set according to the reaction and the response time of the electrode.

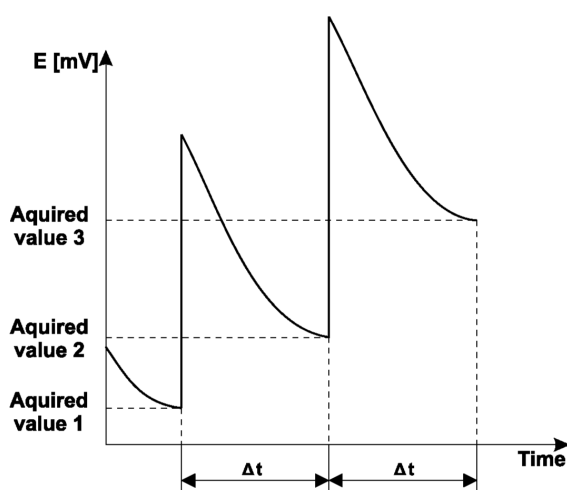

**Timed Increment**

Enter the period of time to wait until the next dose.

5 seconds

The range is from 2 to 180 seconds.

Accept	Escape	Delete Digit	
--------	--------	--------------	--

#### 4.5.15. ELECTRODE TYPE

Option: Up to 20 characters

**Electrode Type**

Select the highlighted letter by using the arrow keys then press "Enter". Select the empty field for a space. Press Accept to save the electrode type.

<input checked="" type="checkbox"/>	A	B	C	D	E	F	G	H	I	J	K	L						
<input type="checkbox"/>	M	N	O	P	Q	R	S	T	U	V	W	X	Y					
<input type="checkbox"/>	Z	a	b	c	d	e	f	g	h	i	j	k	l					
<input type="checkbox"/>	m	n	o	p	q	r	s	t	u	v	w	x	y					
<input type="checkbox"/>	z	À	Á	Â	Ã	Ä	Å	Ç	È	É	Ê	Ë	Ì	Í	Î	Ï	Ñ	
<input type="checkbox"/>	Ò	Ó	Ô	Õ	Ö	Ù	Ú	Û	Ü	ß	à	á	â	ã	ä	å	ö	ø
<input type="checkbox"/>	ä	ç	è	é	ê	ë	ì	í	î	ï	ñ	ò	ó	ô	õ	ö	ø	ù
<input type="checkbox"/>	ú	û	ü	¿	¡	*	\	_	\$	'	^	#	:					
<input type="checkbox"/>	0	1	2	3	4	5	6	7	8	9	%	.	,					
<input type="checkbox"/>	?	!	(	)	[	]	<	>	=	/	+	-						

pH

Accept	Escape	Delete Letter	Cursor Left	Cursor Right
--------	--------	---------------	-------------	--------------

#### 4.5.16. BLANK OPTION

Option: Disabled, V-Blank, Blank-V

This feature allows the user to select the procedure for the blank calculations (where V is the volume of titrant dispensed during the titration and blank is the volume of titrant consumed by the blank sample).

**View/Modify Method**

Id: USER0003      Modified: 09:40 May 23, 2018

Select the option to be modified.

Analysis Type:	Standard Titration
Analog Board:	Analog 1
Stirrer Configuration:	
Titration pump:	Pump 1
Reagent Addition 1:	Disabled
Reagent Addition 2:	Disabled
Dosing Type:	Dynamic
End Point Mode:	mV 3EQ points, 1st Der
Recognition Options:	
Pre-Titration Volume:	U - Blank
Pre-Titration Stir Time:	Blank - U
Measurement Mode:	Sign: No Blank
Electrode Type:	
Blank Option:	No Blank

Select	Escape	Print Method	Page Up	Page Down
--------	--------	--------------	---------	-----------

If one of the options (V-Blank or Blank-V) is selected in the **View / Modify Method** screen, the *blank value* will be active on the **View / Modify Method** screen and the value of the blank can be set (in liters).

Blank Value				
Enter the blank volume in liters.				
0.00125 L				
Accept	Escape	Delete Digit		Exponent

#### 4.5.17. CALCULATIONS

The final result is calculated using the endpoint volume (titrant volume at the equivalence point or at the fixed endpoint), and a formula selected by the user.

Calculations												
Select either the calculation to be performed or modify the variables.												
<table border="1"> <tbody> <tr><td>Edit Variable Values</td></tr> <tr><td>No Formula (mL only)</td></tr> <tr><td>No Formula (L only)</td></tr> <tr><td>Sample Calc. by Weight</td></tr> <tr><td>Sample Calc. by Volume</td></tr> <tr><td>Stdz. Titrant by Weight</td></tr> <tr><td>Stdz. Titrant by Volume</td></tr> <tr><td>Generic Formula</td></tr> </tbody> </table>					Edit Variable Values	No Formula (mL only)	No Formula (L only)	Sample Calc. by Weight	Sample Calc. by Volume	Stdz. Titrant by Weight	Stdz. Titrant by Volume	Generic Formula
Edit Variable Values												
No Formula (mL only)												
No Formula (L only)												
Sample Calc. by Weight												
Sample Calc. by Volume												
Stdz. Titrant by Weight												
Stdz. Titrant by Volume												
Generic Formula												
Select	Escape											

##### 4.5.17.1. Standard Titration Calculations

###### 4.5.17.1.1. Edit Variable Values

Edit the variables in a previously selected calculation.

For each formula, selected variables can be changed.

###### 4.5.17.1.2. No Formula (mL only)

Only the volume of titrant (mL) required to reach the endpoint will be displayed.

###### 4.5.17.1.3. No Formula (L only)

Only the volume of titrant (L) required to reach the endpoint is displayed.



#### 4.5.17.1.4. Sample Calculations by Weight

##### Titrant units

Option: M (mol / L), N (eq / L), g / L, mg / L

##### Final result units

Option: ppt (g / kg), ppm (mg / kg), ppb ( $\mu\text{g}$  / kg), % (g / 100 g), mg / g, mg / kg, mol / kg, mmol / g, eq / kg, meq / kg

This calculation is used when the concentration of an analyte is determined by the weight of the sample. The results are based on the initial sample weight (in grams).

The titrator will calculate the results based on the titrant and sample units selected.

A formula example is shown below using M (mol / L) as the titrant unit and ppt (g / kg) as the final result unit:

Variables can be set according to the amount of sample and titrant used.

Calculating Sample Concentration

M (mol/L) --> ppt (g/kg)

The calculation is:

$$\frac{U \times \frac{\text{mol}}{\text{L}} \times \frac{\text{mol}}{\text{mol}} \times \frac{\text{g}}{\text{mol}}}{\text{g} \times \frac{\text{kg}}{1000\text{g}}}$$

Select the variables to change value.  
U = volume dispensed in liters.

1.000 mol/L -> titrant conc.

1.000 mol/mol -> (sample/titrant)

1.000 g/mol -> mw of sample

1.000 g -> sample weight

Select	Escape	Save / Exit		
--------	--------	----------------	--	--

#### 4.5.17.1.5. Sample Calculations by Volume

##### Titrant Units

Option: M (mol / L), N (eq / L), g / L, mg / L

##### Final Result Units

Option: ppt (g/L), ppm (mg/L), ppb ( $\mu\text{g}$ /L), M (mol/L), N (eq/L), mg/L,  $\mu\text{g}$ /L, mmol/L, mg/mL, mg/100 mL, g / 100 mL, eq / L, meq / L

This calculation is used when the concentration of an analyte is determined in terms of the volume of sample. The results are based on the initial sample volume (in milliliters).

The titrator will calculate the results based on the selected units.

A formula example is shown below using N (eq / L) as the titrant units and g / L as the final result units. Variables can be set according to the amount of sample and titrant used.

Calculating Sample Concentration

M (mol/L) --> mol/L

The calculation is:

$$\frac{U \times \frac{\text{mol}}{\text{L}} \times \frac{\text{mol}}{\text{mol}}}{\text{mL} \times \frac{\text{L}}{1000\text{mL}}}$$

Select the variables to change value.  
U = volume dispensed in liters.

1.000 mol/L -> titrant conc.

1.000 mol/mol -> (sample/titrant)

100.00 mL -> sample volume

Select	Escape	Save / Exit	
--------	--------	----------------	--

#### 4.5.17.1.6. Standardize Titrant by Weight

**Option:** M (mol /L), N (eq / L), g / L, mg / L

This calculation is used when the concentration of the titrant is determined using a solid standard. Determination of the titrant concentration is based on the primary standard weight (in grams).

The calculation is based on the selected titrant unit. If the titrant unit is M (mol / L), the formula used to calculate the result is displayed below.

Calculating Titrant Concentration

The titrant concentration unit is M (mol/L).

The calculation is:

$$\frac{g \times \frac{\text{mol}}{\text{g}} \times \frac{\text{mol}}{\text{mol}}}{U}$$

Select the variables to change value.  
U = volume dispensed in liters.

0.200 g -> standard weight

204.23 g/mol -> mw of standard

1.000 mol/mol -> (titrant/standard)

Select	Escape	Save / Exit	
--------	--------	----------------	--

#### 4.5.17.1.7. Standardize Titrant by Volume

**Option:** M (mol /L), N (eq / L), g / L, mg / L

This calculation is used when the concentration of the titrant is determined using a primary standard solution. Determination of the titrant concentration is based on the primary standard volume (in milliliters).

The calculation is based on the selected titrant unit. If the titrant unit is N (eq / L), the formula used to calculate the result is displayed below.

**Calculating Titrant Concentration**

The titrant concentration unit is N (eq/L).

The calculation is:

$$\frac{\text{mL} \times \frac{\text{L}}{1000\text{mL}} \times \frac{\text{eq}}{\text{L}}}{V}$$

Select the variables to change value.  
U = volume dispensed in liters.

1.684 mL -> standard volume
2.375 eq/L -> standard conc.

Select	Escape	Save / Exit	
--------	--------	----------------	--

#### 4.5.17.1.8. Generic Formula

Final results units:

Option: ppt (g / kg), ppt (g / L), ppm (mg / kg), ppm (mg / L), ppb ( $\mu\text{g}$  / kg), ppb ( $\mu\text{g}$  / L), % (g / 100 g), M (mol / L), mg / g, N (eq / L), g / L, mg / kg, mg / L, mol / kg,  $\mu\text{g}$  / L, mol / L, mmol / g, eq / kg, mmol / L, meq / kg, mg / mL, mg / 100 mL, g / 100 mL, eq / L, meq / L, no unit

Users can define their own calculation formula based on the final result units in a solid or liquid sample.

The titrator will calculate the results based on the selected unit.

The formula can be either for titrant standardization or sample analysis.

**Calculating Sample Concentration**

Final unit is mg/L.

The calculation is:

$$\frac{C \times U \times F1 \times F2 \times F3}{S}$$

Select the variables to change value.  
U = volume dispensed in liters.

1.000 C -> (titrant conc.)
1.000 F1 -> (general factor)
1.000 F2 -> (general factor)
1.000 F3 -> (general factor)

Select	Escape	Save / Exit	
--------	--------	----------------	--

- C            the concentration of the titrant  
 F1, F2, F3    general factor  
 S            sample size, in grams or milliliters  
 V            the volume delivered, in liters, to reach the endpoint

#### General factors

- Weight conversion**    mol / L, eq / L, g / , mg / L  
**Reaction ratio**        mol / mol, mol / eq, eq / mol  
**Unit conversion**        L to mL, g to mg

Weight conversion kg, g, mg,  $\mu\text{g}$ , mole, mmole

#### 4.5.17.2. Back Titrations Calculations

Calculations

Select either the calculation to be performed or modify the variables.

Sample Calc. by Weight

Sample Calc. by Volume

Generic Formula

Select	Escape		
--------	--------	--	--

##### 4.5.17.2.1. Sample Calculations by Weight

Select the titrant 1 unit, titrant 2 unit, and final result unit.

##### Titrant Units

Option: M (mol /L), N (eq / L), g / L, mg / L

##### Final Result Units

Option: ppt (g / kg), ppm (mg / kg), ppb ( $\mu\text{g}$  / kg), % (g / 100 g), mg / g, mg / kg, mol / kg, mmol / kg, eq / kg, meq / kg

A formula example is shown below using M (mol / L) as the titrant 1 units, M (mol / L) as the titrant 2 units, mg / g and the final result units. This formula is used to calculate the amount of titrant 1 to dispense.

Calc. Direct Titr. Volume

Titr1 Unit: M (mol/L)-->Result Unit: L

The calculation is:

$$\frac{\text{g} \times \frac{\text{mol}}{\text{g}} \times f}{\frac{\text{mol}}{\text{L}} \times \frac{\text{mol}}{\text{mol}}}$$

Select the variables to change value.

1.000 g -> sample weight

1.000 g/mol -> mw of sample

1.000 f ->(excess factor)

1.000 mol/L -> titrant 1 conc.

Select	Escape		Next
--------	--------	--	------

The formula is based on the assumption that the sample concentration is 100% w / w.

The titrator will calculate the volume of titrant 1 needed to consume the sample and multiply it with the excess factor in order to raise or lower the amount of titrant 1 dispensed.

Variables can be set according to the amount of sample and titrant used.

Press Next to proceed to the next formula.

If you do not want the titrator to calculate the volume of titrant 1 to be added. See [4.5.23. TITRANT 1 ENTRY \(BACK TITRATION ONLY\)](#) section for more information.

The remaining volume of titrant 1 will need to be calculated.

The following formula is used to calculate the remaining volume of titrant 1 after the reaction with the sample.

**Calc. Excess Volume Of Titr1.**

M (mol/L) + M (mol/L) --> L

The calculation is:

$$\frac{V2 \times \frac{\text{mol}}{\text{L}} \times \frac{\text{mol}}{\text{mol}}}{\frac{\text{mol}}{\text{L}}}$$

U1 = V1tot - U1 excess  
 Select the variables to change value.  
 U2 = backtitr. vol. dispensed in liters.

1.000 mol/L -> titrant 2 conc.
1.000 mol/mol -> (titrant 1/titrant 2)
1.000 mol/L -> titrant 1 conc.

Select	Escape		Next
--------	--------	--	------

When all the variables are set, press Next to proceed with the "Calculating Sample Concentration" formula.

#### 4.5.17.2.2. Sample Calculations by Volume

Select the titrant 1 unit, titrant 2 unit, and the final result unit.

##### Titrant Units

Option: M (mol / L), N (eq / L), g / L, mg / L

##### Final Result Units

Option: ppt (g / L), ppm (mg / L), ppb ( $\mu\text{g}$  / L), M (mol / L), N (eq / L), mg / L,  $\mu\text{g}$  / L, mmol / L, mg / mL, mg / 100 mL, g / 100 mL, eq / L, meq / L

After you have selected the titrant 1, titrant 2, and the final result units, the titrator will display the formula used to calculate the amount of titrant 1 (used in the first stage of back titration) to be dispensed.

**Calc. Direct Titr. Volume**

Titr1 Unit: M (mol/L)-->Result Unit: L

The calculation is:

$$\frac{\text{mL} \times \frac{\text{L}}{1000\text{mL}} \times \frac{\text{g}}{\text{L}} \times \frac{\text{mol}}{\text{g}} \times f}{\frac{\text{mol}}{\text{L}} \times \frac{\text{mol}}{\text{mol}}}$$

Select the variables to change value.

1.000 mL -> sample volume
1.000 g/L -> sample max conc.
1.000 g/mol -> mw of sample
1.000 f ->(excess factor)

Select	Escape		Next
--------	--------	--	------

The formula is based on the assumption that the sample concentration is 100% v / v. The titrator will calculate the volume of titrant 1 needed to consume the sample and multiply it with the excess factor in order to raise or lower the amount of titrant 1 dispensed.

Variables can be set according to the amount of sample and titrant used.

Press Next to proceed to the next formula.

If you do not want the titrator to calculate the volume of titrant 1 to be added. See [4.5.23. TITRANT 1 ENTRY \(BACK TITRATION ONLY\)](#) section for more information.

The following formula is used to calculate the remaining volume of titrant 1 after the reaction with the sample.

**Calc. Excess Volume Of Titr1.**

$M \text{ (mol/L)} + M \text{ (mol/L)} \rightarrow L$

The calculation is:

$$\frac{U2 \times \frac{\text{mol}}{\text{L}} \times \frac{\text{mol}}{\text{mol}}}{\frac{\text{mol}}{\text{L}}}$$

U1 = V1tot - U1 excess  
 Select the variables to change value.  
 U2 = backtitr. vol. dispensed in liters.

1.000 mol/L -> titrant 2 conc.
1.000 mol/mol -> (titrant 1/titrant 2)
1.000 mol/L -> titrant 1 conc.

Select	Escape		Next
--------	--------	--	------

When all the variables are set, press Next to proceed with the "Calculating Sample Concentration" formula.

**Calculating Sample Concentration**

Final unit is g/L:

The calculation is:

$$\frac{U1 \times \frac{\text{mol}}{\text{L}} \times \frac{\text{mol}}{\text{mol}}}{\frac{\text{mL}}{\text{L}} \times \frac{\text{L}}{1000\text{mL}} \times \frac{\text{mol}}{\text{g}}}$$

Select the variables to change value.  
 U1 = volume dispensed in liters

1.000 mol/L -> titrant 1 conc.
1.000 mol/mol -> (sample/titrant 1)
1.000 mL -> sample volume
1.000 g/mol -> mw of sample

Select	Escape	Save / Exit	
--------	--------	----------------	--

#### 4.5.17.2.3. Generic Formula

Users can define their calculation formula for the "Direct Titration Volume", "Calculating Excess Volume of Titrant 1" and "Final Sample Concentration" in a solid or liquid sample.

#### 4.5.18. DILUTION OPTION

Option: Enabled or Disabled

When the initial sample is diluted, a titration is made with an aliquot of the diluted sample, dilution calculations can be used. The calculations are based on the original sample weight or volume in order to express the results for the initial sample.

Dilution Parameters

Select the option.

Final Dilution Volume:	100.000 mL
Aliquot Volume:	10.000 mL
Analyte size to be diluted:	1.0000 mL

Select	Escape		
--------	--------	--	--

**Final Dilution Volume**      The volume of the sample after dilution

**Aliquot Volume**              Volume of sample taken from the dilution for titration

**Analyte size to be diluted**    The initial sample weight or volume

#### 4.5.19. TITRANT NAME

Option: Up to 15 characters

Titrant1 Name

Select the highlighted letter by using the arrow keys then press "Enter".  
Select the empty field for a space.  
Press Accept to save the entered text.

█	A	B	C	D	E	F	G	H	I	J	K	L
M	N	O	P	Q	R	S	T	U	V	W	X	Y
Z	a	b	c	d	e	f	g	h	i	j	k	l
m	n	o	p	q	r	s	t	u	v	w	x	y
z	À	Á	Â	Ã	Ä	Å	Æ	È	É	Ê	Ë	Ì
Í	Î	Ï	Ñ	Ò	Ó	Ô	Õ	Ö	Ø	Ù	Ú	Û
Ü	Ý	à	á	â	ã	ä	å	æ	è	é	ê	ë
ì	í	î	ï	ñ	ò	ó	ô	õ	ö	ø	ù	ú
û	ü	ý	ÿ	ı	*	\	_	\$	'	^	#	:
0	1	2	3	4	5	6	7	8	9	%	.	,
?	!	(	)	[	]	<	>	=	/	+	-	'

0.1N NaOH

Accept	Escape	Delete Letter	Cursor Left	Cursor Right
--------	--------	---------------	-------------	--------------

**Note:** For back titrations the name of titrant 1 and titrant 2 can be entered.

#### 4.5.20. TITRANT CONCENTRATION

Enter the concentration of the titrant to be used. When determining the titrant concentration, only the concentration unit is displayed.

**Note:** For back titrations the concentration of titrant 1 and titrant 2 can be entered.

<p style="color: red;">Titrant1 Conc.</p> <p>Enter the titrant 1 concentration.</p> <p style="text-align: center;">0.10676 M (mol/L)</p>				
Accept	Escape	Delete Digit		Exponent

#### 4.5.21. ANALYTE SIZE

Option: 0.001 to 250.0

Enter the size of the sample (for sample-concentration determination) or standard (for titrant-concentration determination).

<p style="color: red;">Sample Volume</p> <p>Enter the initial sample volume in milliliters.</p> <p style="text-align: center;">1.0000 mL</p> <p>This volume will be used when fixed sample size is selected.</p>				
Accept	Escape	Delete Digit		Exponent

**Note:** For back titrations the concentration of titrant 1 and titrant 2 can be entered.



#### 4.5.22. ANALYTE ENTRY

Option: Fixed, Manual, Same as Previous (linked methods only)

Analyte Entry							
Select the entry mode of analyte.							
<table border="1"> <tr> <td>Fixed Weight or Volume</td> </tr> <tr> <td>Manual Weight or Volume</td> </tr> <tr> <td>Same as Previous</td> </tr> </table>					Fixed Weight or Volume	Manual Weight or Volume	Same as Previous
Fixed Weight or Volume							
Manual Weight or Volume							
Same as Previous							
Verify the correct formula is being used, i.e. weight or volume analyte type.							
Select	Escape						

**Fixed Weight or Volume**

For each titration will use a set weight or volume in the calculations.

**Manual Weight or Volume**

For each titration the exact weight or volume can be entered at the beginning of each titration.

**Same as Previous (Linked Method)**

The same weight or volume is used for both methods.

#### 4.5.23. TITRANT 1 ENTRY (BACK TITRATION ONLY)

Select the mode for evaluating the necessary quantity of titrant 1 used in the back titration process (phase 1).

Titrant 1 Entry						
Select the entry mode of titrant 1.						
<table border="1"> <tr> <td>Calculated By Formula</td> </tr> <tr> <td>Fixed By User</td> </tr> </table>					Calculated By Formula	Fixed By User
Calculated By Formula						
Fixed By User						
Select	Escape					

**Calculated by Formula**

The volume of titrant 1 to be dispensed in the phase 1 of back titration will be calculated by the titrator. See [4.5.17.2. Back Titrations Calculations](#) section for more information.

**Fixed by User**

A fixed volume of titrant 1 will be used during the first phase of back titration process (direct titration).

#### 4.5.24. MAXIMUM TITRANT VOLUME

Option: 0.100 to 100.000 mL

The maximum titrant volume used in the titration must be set according to the analysis.

If the titration endpoint (fixed or equivalence point) is not reached, the titration will be terminated after the maximum titrant volume has been dispensed. The error message "Limits Exceeded" will appear on the display.

Maximum Titrant Volume				
Enter the maximum titrant volume to be dispensed.				
15.000 mL				
Recommend the total volume of the burette.				
Accept	Escape	Delete Digit		

#### 4.5.25. POTENTIAL RANGE

Option: -2000.0 to 2000.0 mV

The input potential range can be set by the user. The titration will be terminated and an error message will appear if the potential is outside these limits.

These limits provide protection against a titration that does not generate an endpoint due to potential over-range.

Potential Range				
Enter the upper and lower potential.				
2000.0 mV - Upper Limit				
-2000.0 mV - Lower Limit				
Press Next to move to the next entry.				
Accept	Escape	Delete Digit	Next	

#### 4.5.26. VOLUME / FLOW RATE

The flow rate for the dosing system can be set by the user in an interval of 0.3 to 2 times the burette volume:

5 mL burette 0.3 to 10 mL/min

10 mL burette 0.3 to 20 mL/min

25 mL burette 0.3 to 50 mL/min

50 mL burette 0.3 to 100 mL/min

The flow rate is set for all burette operations.

Flow Rate				
Enter the titrant/reagent flow rate.				
50.0 mL/min				
The range is from 0.1 to twice the total volume of the burette.				
Accept	Escape	Delete Digit		

**Note:** The titrator will automatically detect the burette size and display the correct high limit volume.

#### 4.5.27. SIGNAL AVERAGING

Option: 1, 2, 3, 4 readings

This option enables filtering on the mV / pH reading.

If 1 Reading is selected, the filtering is disabled. The titrator will take the last reading and place it into a “moving window” along with the last 2, 3 or 4 readings (depending on the selected option). The average of those readings is displayed and used for calculations.

Averaging more readings is helpful when a noisy signal is received from the electrode.

View/Modify Method	
Id: USER0001 Modified: 15:58 Jun 28, 2018	
Select the option to be modified.	
Electrode Type:	pH
Blank Option:	No Blank
Calculations:	Sample Calc. by Volume
Dilution Option:	Disabled
Titrant Name:	0.1N NaOH
Titrant Conc.:	0.1
Analyte Size:	1 Reading
Analyte Entry:	2 Readings
Maximum Titrant Volume:	3 Readings
Potential Range:	4 Readings
Volume/Flow Rate:	25 mL
Signal Averaging:	1 Reading
Significant Figures:	XXXXX
Linked To:	No Link
Select	Escape
Print Method	Page Up
	Page Down

#### 4.5.28. SIGNIFICANT FIGURES

Option: Two (XX), Three (XXX), Four (XXXX) or Five (XXXXX)

This option allows you to set the format for displaying the final titration result.

```

View/Modify Method
Id: USER0005    Modified: 10:18 May 23, 2018
Select the option to be modified.

Pre-Titration Stir Time:      60 sec
Measurement Mode:             Signal Stability
Electrode Type:                pH
Blank Option:                  No Blank
Calculations:                   Stdz. Titrant by Weight
Dilution Option:              Disabled
Titrant Name:                  0.1N NaOH
Analyte Size:                  0
Analyte Entry:                 XX
Maximum Titrant Volume:       15 XXX
Potential Range:              -2000.0 to 20 XXXX
Volume/Flow Rate:             25 mL / 50.0 XXXXX
Signal Averaging:              1
Significant Figures:           XXXXX
  
```

Select	Escape	Print Method	Page Up	Page Down
--------	--------	--------------	---------	-----------

#### 4.5.29. LINKED METHOD

This option allows the user to link two titration methods. If No Link is selected, only the current method will run. If a method is selected, it will run after the current method.

```

Link Titration Method

Select the method to be linked.

----- No Link
USER0001 Acidity of Water
USER0009 Free acidity
USER0010 Wine acidity
  
```

Select	Escape			
--------	--------	--	--	--

#### 4.5.30. START LINKED METHOD (LINKED METHOD ONLY)

##### Option: Manually or Automatically

Selecting Manually will stop the titration temporarily between the methods. This break allows you to perform a task related to the analysis (e.g.: boiling the sample to remove carbon dioxide).

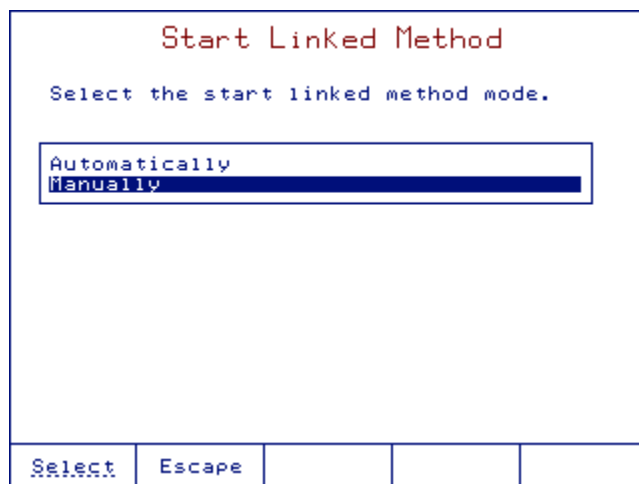

#### 4.6. PRINTING

To print method parameters, press Method Options from the main screen.

Press Print Method and wait a few seconds until the printer completes the job.

If no printer is connected to the dedicated socket, or if the printer is offline, an error message will appear on the display.

See [10.2.1. CONNECTING TO A PRINTER](#) section for details on connecting a printer to the titrator.

## 5. TITRATION MODE

### 5.1. RUNNING A TITRATION

Before beginning a titration, make sure that the following conditions are met:

- At least one pump is properly installed.
- A burette is inserted in the pump and filled with titrant.
- The aspiration tube is inserted in the titrant bottle and primed. The dispensing tube is over the titration beaker.
- The tubes are installed on the peristaltic pump and filled with reagent.
- The standard or sample has been carefully weighed / measured into the beaker.
- The electrode(s) and the temperature probe are submersed in the beaker.
- The desired method is selected and the parameters are set to the optimal values.

#### 5.1.1. STARTING A TITRATION

To start a new analysis, press  from the main screen.

When an analysis begins:

- The stirrer will turn on, if enabled. See [4.5.5. STIRRER CONFIGURATION](#) section for more information.
- The quantity of reagent will be added according to the parameters set in the method, if enabled. See [4.5.7. REAGENT ADDITION](#) section for more information.
- The pre-titration volume will be dispensed, if enabled. See [4.5.12. PRE-TITRATION VOLUME](#) section for more information.
- After the pre-titration volume is added the pre-titration stir time starts, if enabled. See [4.5.13. PRE-TITRATION STIR TIME](#) section for more information.
- The titrator will start the analysis and continue to deliver titrant until the endpoint is detected or the titration is terminated.

#### 5.1.2. SUSPENDING A TITRATION

While a titration or analysis is in progress, you can temporarily stop it by pressing . This will stop the dosing pump if it is running.

To continue the titration or analysis press .

#### 5.1.3. VIEWING THE TITRATION CURVE

During a titration, the potentiometric curve and the derivative curve (equivalence point only) can be displayed on the **Titration Graph** screen by pressing .

The potentiometric curve and the derivative curve are scaled to fit simultaneously inside the display.

When a titration endpoint is successfully detected, the volume is displayed on the graph and marked with an "x".

The contents of the graph as related to an endpoint type are as follows:

<b>Equivalence endpoint (pH)</b>	The pH readings and the selected derivative vs. volume of titrant are displayed (see Figure 1).
<b>Equivalence endpoint (mV)</b>	The mV readings and the selected derivative vs. volume of titrant are displayed (see Figure 2).
<b>Fixed endpoint (pH)</b>	The pH readings vs. volume of titrant are displayed (see Figure 3).
<b>Fixed endpoint (mV)</b>	The mV readings vs. volume of titrant are displayed (see Figure 4).

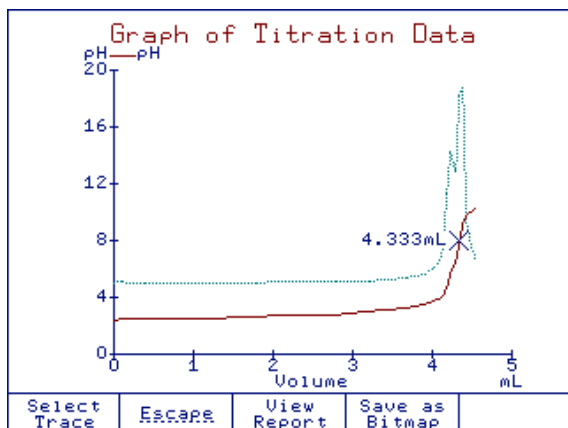

Figure 1 Equivalence endpoint (pH)

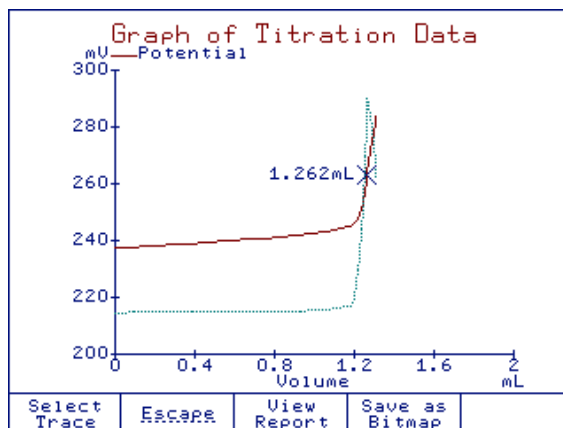

Figure 2 Equivalence endpoint (mV)

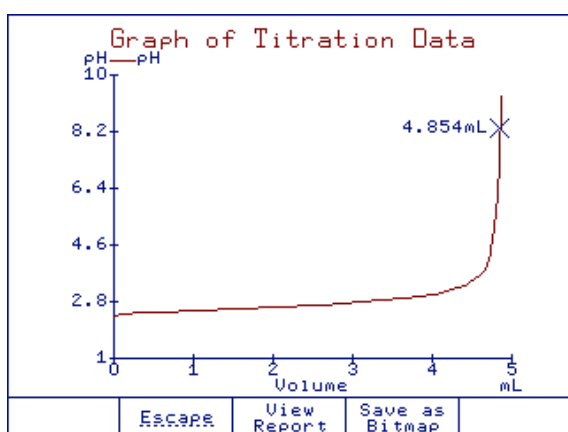

Figure 3 Fixed endpoint (pH)

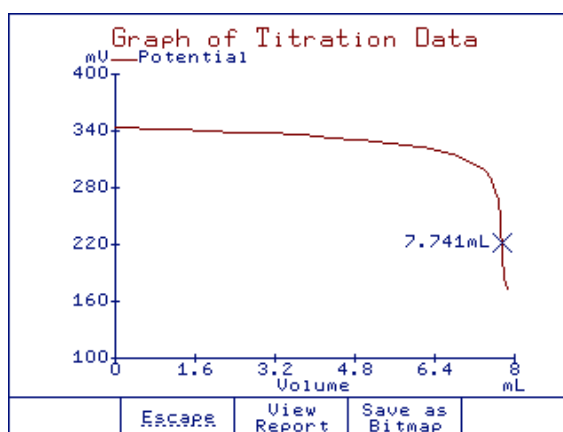

Figure 4 Fixed endpoint (mV)

Select Trace	Changes the y-axis from the pH (mV) reading to the derivate value (equivalence point titrations only).
Save as Bitmap	Saves the graph as a bitmap (available when titration is complete).

## 5.2. STOPPING A TITRATION / DIRECT READING

The titration or analysis is terminated when one of the following conditions is met:

### Analysis completed

This is the only mode with valid final result values. The endpoint or stable reading was successfully detected, the final results will be displayed.

### Manually terminated

The current titration or analysis was terminated by the user before the endpoint was detected.

### Limits exceeded

The maximum titrant volume was delivered without reaching the endpoint. An error message is displayed on the screen.

### Critical error

A critical error occurred and the titration was stopped. These errors are typically related to the dosing system. An error message is displayed on the screen.

### Potential out of range

The measured values from the electrode are outside the potential range. An error message is displayed on the screen.

## 6. pH MODE

By pressing  from the main screen, the titrator can be switched to **Titration**, **pH**, **mV** or **ISE** modes.

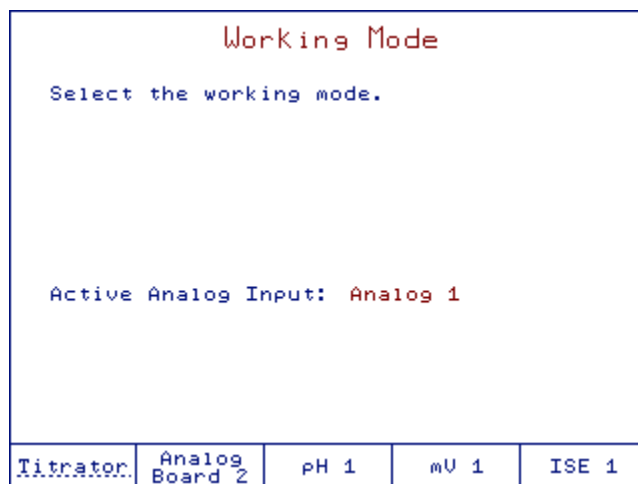

When one of these keys is pressed, the titrator will enter the selected mode:

- Switches to **Titration** mode.
- or  Switches the Analog Input for **pH**, **mV** and **ISE** mode (if second analog board is installed).
- or  Switches to **pH** mode.
- or  Switches to **mV** mode.
- or  Switches to **ISE** mode.



## 6.1. DISPLAY

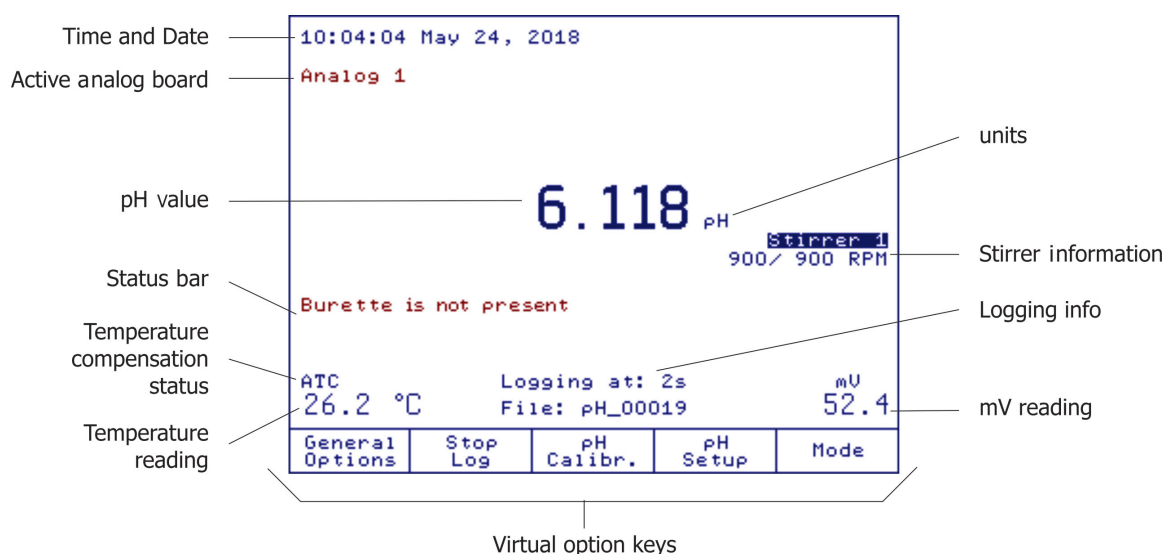

If one of these keys is pressed, the associated function is immediately performed. Some of the keys are active only in specific screens:

**General Options** Gives access to options that are not directly related to the measurement process. See [3. GENERAL OPTIONS](#) section for more information.

**Save Reading** Stores the current pH reading. See [6.4. LOGGING](#) section for more information.

OR

**Start Log** Starts the interval log. See [6.4. LOGGING](#) section for more information.

**pH Calibr.** Enters the pH calibration screen. See [6.3. pH CALIBRATION](#) section for more information.

**pH Setup** Enters the pH setup screen, parameters are associated with pH measurements and calibration. See [6.2. pH SETUP](#) section for more information.

**Mode** Allows the user to switch between the available measurement modes: **Titrator**, **pH**, **mV** or **ISE** mode.

## 6.2. pH SETUP

To access pH Setup, press **pH Setup** option key while in pH mode.



Use **▲** and **▼** keys to highlight the desired option.

Press **Select** or **enter** to access the selected option.

### 6.2.1. BUFFER ENTRY TYPE

Option: Automatic, Semiautomatic, Manual

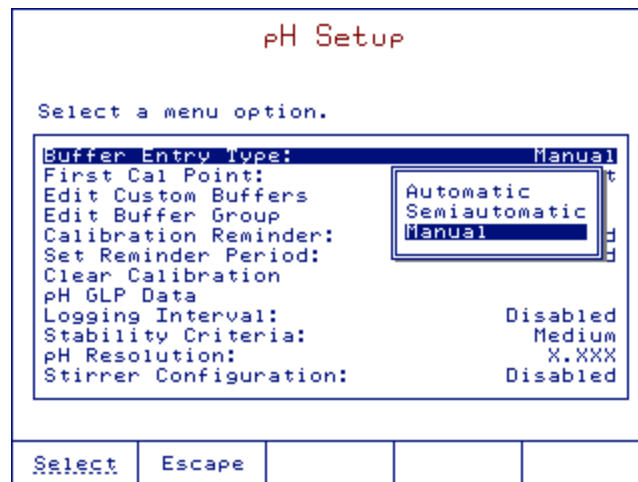

- Automatic** The instrument automatically selects the pH calibration point as the closest buffer from the predefined buffer group. See [6.2.4. EDIT BUFFER GROUP](#) section for more information.
- Semiautomatic** The instrument automatically selects the closest buffer from the available buffers (standard and custom buffers).
- Manual** The calibration buffer must be manually selected during calibration from the available buffer list (standard and custom buffers).

### 6.2.2. FIRST-CALIBRATION POINT

Option: Point or Offset

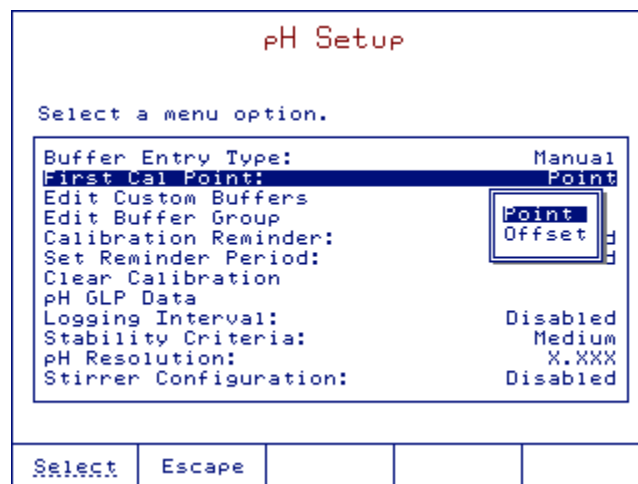



- Point** The slope values adjacent to the calibration points will be reevaluated (normal calibration).
- Offset** The existing slope values will not be changed.

### 6.2.3. EDIT CUSTOM BUFFERS

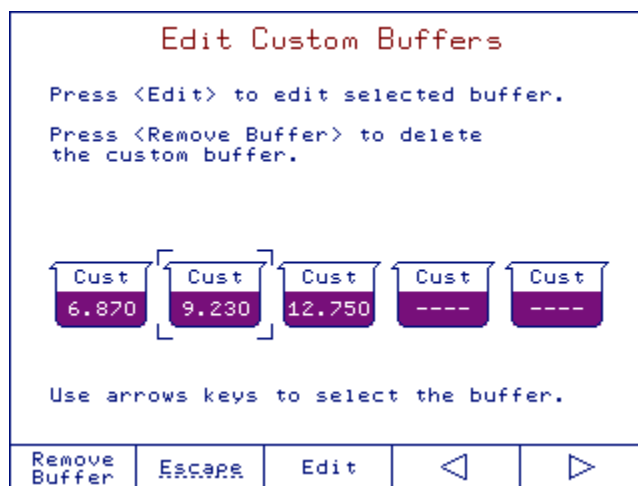

If you wish to use buffers other than the standard ones, use the Edit Custom Buffers option to set the desired pH value. Up to five pH custom buffers can be set.

**Note:** Custom buffers are not temperature compensated, enter the value of the buffer at the calibration temperature.

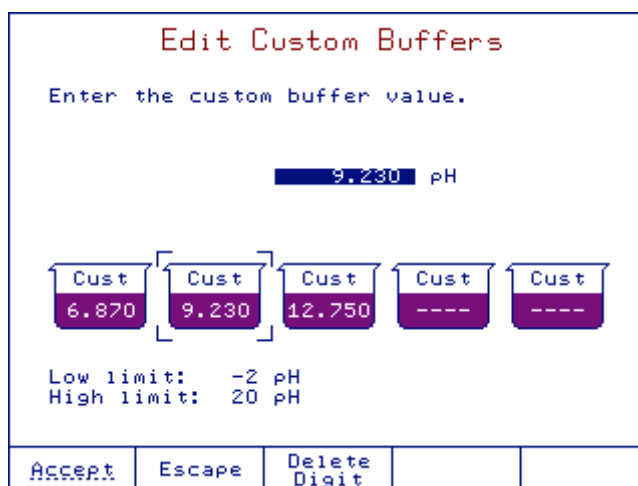

1. Use the < and > keys to select the desired buffer.
2. Press  to delete the selected buffer.
3. Press  to edit the selected buffer.



4. Use the numeric keypad to enter the pH buffer value.
5. Press  to save the value.
6. Press  to return to pH Setup menu.

### 6.2.4. EDIT BUFFER GROUP

**Option: Up to five buffers**

Select up to five buffers from the available buffers (Hanna or custom) to be used for automatic buffer recognition.

Within the buffer group, pH values must be at least 1.5 pH apart.

If the buffer group already contains five pH buffers, at least one pH buffer has to be removed in order to add another buffer.

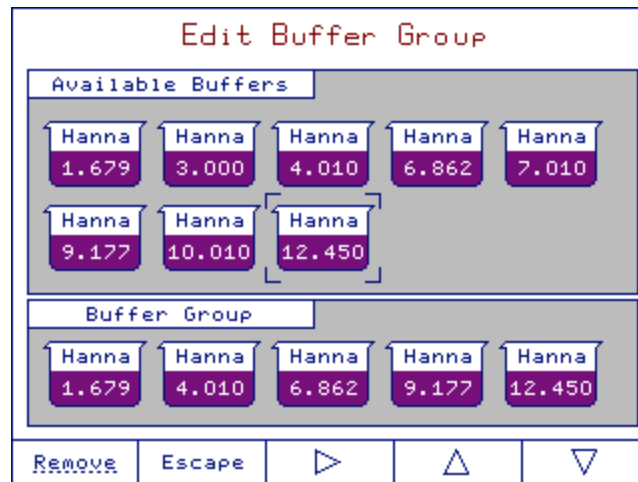

Use the arrow keys to select the pH buffer to be included / removed in / from the buffer group.

**Add** or **Remove** Adds or removes the selected pH buffer to / from buffer group.

**Escape** Returns to pH Setup menu.

### 6.2.5. CALIBRATION REMINDER

**Option: Daily, Periodic, Disabled**

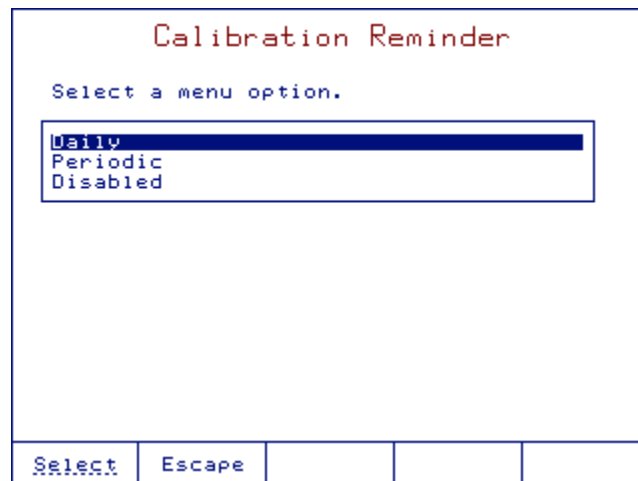

**Daily** The calibration reminder will appear daily at a specified time.

**Periodic** The calibration reminder will appear after the set time since the last calibration has elapsed.

**Disabled** The calibration reminder will not appear.

### 6.2.6. SET REMINDER PERIOD

**Option: Disabled to 31 days, 23 hours and 59 minutes**

If *Daily* or *Periodic* option was selected for the calibration reminder, the reminder period must also be set.

For a daily reminder period, the time of day can be set.

For a periodic reminder period, the number of days, hours and minutes can be set.

<b>Periodic Calibration Reminder</b> Enter the time period that must be passed since the last calibration, whereafter the calibration reminder appears.  <div style="display: flex; justify-content: space-around; align-items: center;"> <div style="text-align: center;">10 days</div> <div style="text-align: center;">2 hours</div> <div style="text-align: center;">30 minutes</div> </div> Press Next to move to the next entry.  <div style="display: flex; justify-content: space-between; border-top: 1px solid black; padding-top: 5px;"> <span>Accept</span> <span>Escape</span> <span>Delete Digit</span> <span>Next</span> <span>Off</span> </div>				
---	--	--	--	--

- Next Moves the cursor to the next field.
- Accept Saves the changes or Escape to return to the previous screen.
- Off Disables the calibration reminder and return to pH setup.

### 6.2.7. CLEAR CALIBRATION

This option clears the existing pH calibration for the selected channel. If the calibration is cleared, the factory calibration will be used.

- Clear Clears the previous calibration or Escape to return to the previous screen without clearing the calibration.

<b>Clear Calibration</b>  Press <Clear> to clear all calibration points.   Press <Escape> to return without clearing the calibration points.  <div style="display: flex; justify-content: space-between; border-top: 1px solid black; padding-top: 5px;"> <span>Clear</span> <span>Escape</span> <span></span> <span></span> <span></span> </div>				
--	--	--	--	--

### 6.2.8. pH GLP DATA

Display the pH calibration data.

pH GLP Data				
Analog 1				
Last Calibration:		10:13 May 24, 2018		
Offset: -0.1 mV		Average Slope: 100.7%		
1.679pH (Hanna)	316.2mV	26.3°C	A	
10:10:30 May 24, 2018				
4.010pH (Hanna)	177.5mV	26.3°C	A	
10:09:11 May 24, 2018				
7.010pH (Hanna)	-0.6mV	26.3°C	A	
10:08:40 May 24, 2018				
10.010pH (Hanna)	-179.1mV	26.3°C	A	
10:09:43 May 24, 2018				
12.450pH (Hanna)	-325.6mV	26.3°C	A	
10:13:15 May 24, 2018				
	Escape			

### 6.2.9. LOGGING INTERVAL

Option: 2 seconds to 8h 59 min 59 sec

Set the logging interval to be used- for automatic logging.

Select Off to enable manual logging.

Logging Interval				
Enter the data logging interval.				
<input type="text" value="0"/>	<input type="text" value="0"/>	<input type="text" value="2"/>		
hours	minutes	seconds		
Press Next to move to the next entry.				
Accept	Escape	Delete Digit	Next	Off

## 6.2.10. SIGNAL STABILITY CRITERIA

Option: Fast, Medium, Accurate

pH Setup

Select a menu option.

Buffer Entry Type:	Manual
First Cal Point:	Point
Edit Custom Buffers	
Edit Buffer Group	
Calibration Reminder:	
Set Reminder Period:	
Clear Calibration	
pH GLP Data	
Logging Interval:	
Stability Criteria:	Medium
pH Resolution:	X.XXX
Stirrer Configuration:	Disabled

Select	Escape			
--------	--------	--	--	--

**Fast** Quicker results, less accuracy

**Medium** Medium speed results, medium accuracy

**Accurate** Slower results, high accuracy

## 6.2.11. pH RESOLUTION

Option: One (X.X), Two (X.XX), Three (X.XXX) decimal places

pH Setup

Select a menu option.

Buffer Entry Type:	Manual
First Cal Point:	Point
Edit Custom Buffers	
Edit Buffer Group	
Calibration Reminder:	
Set Reminder Period:	10d
Clear Calibration	
pH GLP Data	
Logging Interval:	
Stability Criteria:	
pH Resolution:	X.XXX
Stirrer Configuration:	Disabled

Select	Escape			
--------	--------	--	--	--

## 6.2.12. STIRRER CONFIGURATION

pH Setup	
Select a menu option.	
Buffer Entry Type:	Manual
First Cal Point:	Point
Edit Custom Buffers	
Edit Buffer Group	
Calibration Reminder:	Disabled
Set Reminder Period:	Disabled
Clear Calibration	
pH GLP Data	
Logging Interval:	Disabled
Stability Criteria:	Medium
pH Resolution:	X.XXX
Stirrer Configuration:	Stirrer 1

Select	Escape			
--------	--------	--	--	--

## 6.2.12.1. Stirrer Option

Option: Disabled, Stirrer 1, Stirrer 2 (if installed)

Stirrer Configuration	
Select a menu option.	
Stirrer Option:	Stirrer 1
Stirring Speed:	1

Disabled
Stirrer 1
Stirrer 2

Select	Escape			
--------	--------	--	--	--

## 6.2.12.2. Stirring Speed

Option: 200 to 2500 RPM

Stirring Speed	
Enter the speed of the stirrer within below range.	
1100 RPM	
The range is from 200 to 2500 RPM.	

Accept	Escape	Delete Digit		
--------	--------	--------------	--	--



### 6.3. pH CALIBRATION

Calibrate the instrument often, especially if high accuracy is required.

The instrument should be recalibrated:

- Whenever the pH electrode is replaced.
- At least once a week.
- After testing aggressive chemicals.
- When “No pH Calibration” or “pH Calibration Expired” message appears on the display.

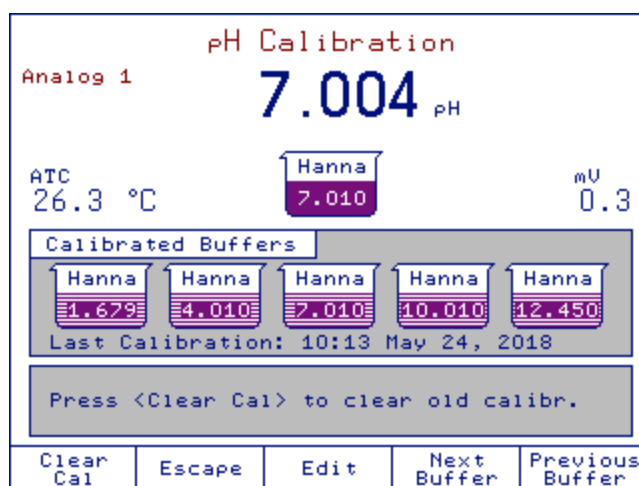

#### Preparation

Pour small quantities of the buffer solutions into clean beakers. If possible, use plastic beakers to minimize any EMC interferences.

For accurate calibration and to minimize cross-contamination, use two beakers for each buffer solution: one for rinsing the electrode and one for calibration. If you are measuring in the acidic range, use pH 7.01 or 6.86 as the first buffer and pH 4.01 / 3.00 or 1.68 as the second buffer. If you are measuring in the alkaline range, use pH 7.01 or 6.86 as the first buffer and pH 10.01 / 9.18 or 12.45 as the second buffer.

For extended range measurements (acidic and alkaline), perform a five-point calibration by selecting five buffers across the entire pH range.

#### Calibration procedure

During calibration, the user has a choice of 8 standard buffers: (pH 1.68, 3.00, 4.01, 6.86, 7.01, 9.18, 10.01, 12.45) and up to 5 custom buffers.

For accurate measurements it is recommended to perform a five-point calibration. However, at least a two-point calibration is suggested. For pH titrations, the selected buffers should bracket your endpoint (e.g. if your endpoint value is at 8.5, use 7.01 or 6.86 and 9.18 or 10.01 for calibration).

To begin calibration:

1. Press . If the instrument was calibrated before, previous calibration can be cleared by pressing .

**Note:** It is very important to clear calibration history when a new electrode is used.

2. Immerse the pH electrode and the temperature probe approximately 4 cm (1.5") into a buffer solution and stir gently.
3. If necessary, select the pH calibration buffer value with  or .

- Once the reading has stabilized, press  to update the calibration. The calibration buffer will be added to the Calibrated Buffers section.
- Rinse the pH electrode and the temperature probe, then immerse them into the next buffer solution and follow the above procedure or press  to exit the calibration.

**Notes:**

- The new calibration points will replace old ones if the difference between them is  $\pm 0.2$  pH.
- Buffers used in previous calibrations will not have a solid background.
- If calibrating with a standard buffer in MTC mode, the pH value and temperature can be modified by pressing . The values can be adjusted using the numeric keys. Press  to save the new values.

Manual Edit				
Edit pH buffer and manual temperature.				
Buffer: <input type="text" value="7.010"/> pH				
Temperature: 25.0 °C				
Low limit: 6.990 pH				
High limit: 7.030 pH				
Press Next to move to the next entry.				
<input type="button" value="Accept"/>	<input type="button" value="Escape"/>	<input type="button" value="Delete Digit"/>	<input type="button" value="Next"/>	

- In ATC mode, the pH value for custom buffers can be modified by pressing .
- If the Automatic Buffer entry type was selected for the calibration procedure, the titrator will automatically select the buffer closest to the measured pH value from the buffer group.
- If the Semiautomatic Buffer entry type was selected, use the  or  to select the buffer. Only buffers in the buffer group will be displayed.

**Calibration messages:****Wrong Buffer. Please check the buffer.**

The message is displayed when the difference between the pH reading and the value of the selected calibration buffer is significant. Check if you have selected the appropriate calibration buffer.

**Wrong buffer temperature.**

The message is displayed if the buffer temperature is out of the defined temperature range.

**Clean the electrode or check the buffer. Press  to update calibration.**

This message alerts the user that some dirt or deposits could be on the electrode, or the buffer is contaminated.

**Slope too low. Please check the buffer .**

This message appears if the current slope is under 80% of the default slope. Recalibrate the instrument using fresh buffers.

**Slope too high. Press  to clear the old calibration.**

This message appears as a result of an erroneous slope condition.

## 6.4. LOGGING

Data logging is available in pH mode. It can be logging on demand (Manual Logging) or automatically (Interval Logging) at predefined time intervals.

The the logging report can be customized. See [9.3.5. SETTING UP pH / mV / ISE REPORT](#) section for more information.

### 6.4.1. INTERVAL LOGGING

The logging interval is set in the pH Setup screen.

Press  to start the log.

The logging interval and name of logging file will be displayed on the measure screen.

To stop the automatic logging, press Stop.

### 6.4.2. MANUAL LOGGING

To manually log pH readings, press  from the pH measurement screen.

A new record will be added to the report every time  is pressed.

## 7. mV MODE

By pressing  from the main screen, the titrator can be switched to **Titration**, **pH**, **mV** or **ISE** modes.

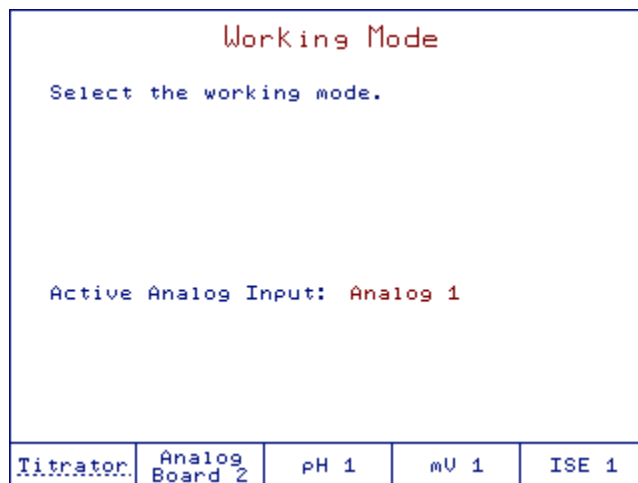

When one of these keys is pressed, the titrator will enter the selected mode:

- Switches to **Titration** mode.
- or  Switches the Analog Input for **pH**, **mV** and **ISE** mode (if second analog board is installed).
- or  Switches to **pH** mode.
- or  Switches to **mV** mode.
- or  Switches to **ISE** mode.

## 7.1. DISPLAY

The mV screen is shown below:

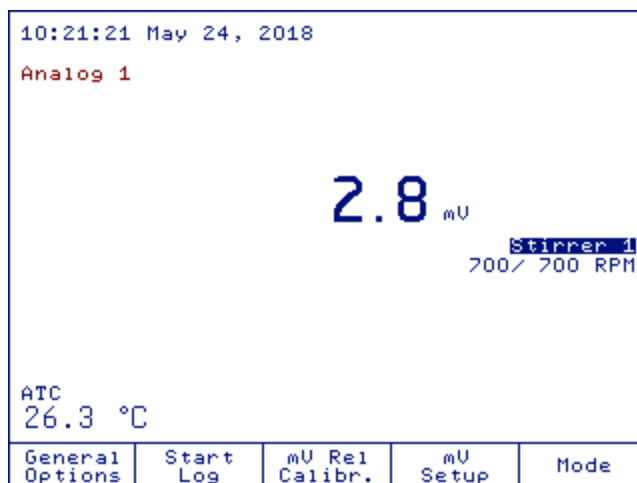

If one of these keys is pressed, the associated function is immediately performed. Some of the keys are active only in specific screens:

**General Options** Gives access to options that are not directly related to the measurement process. See [3. GENERAL OPTIONS](#) section for more information.

**Save Reading** Stores the current pH reading. See [7.4. LOGGING](#) section for more information.

OR

**Start Log** Starts the interval log. See [7.4. LOGGING](#) section for more information.

**mV Calibr.** Enters the pH calibration screen. See [7.3. RELATIVE mV CALIBRATION](#) section for more information.

**pH Setup** Enters the pH setup screen, parameters are associated with pH measurements and calibration. See [7.2. mV SETUP](#) section for more information.

**Mode** Allows the user to switch between measurement modes: **Titrat**or, **pH**, **mV** or **ISE** mode.

## 7.2. mV SETUP

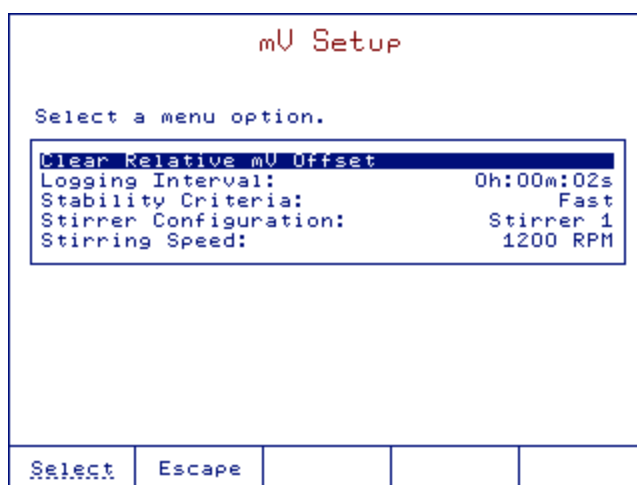

### 7.2.1. CLEAR RELATIVE mV OFFSET

**Clear** Clears the relative mV offset or **Escape** to return to the previous screen.

<b>Clear Relative mV Offset</b> Press Clear to clear the relative mV offset.  Press Escape to return without clearing the relative mV offset.				
Clear	Escape			

### 7.2.2. LOGGING INTERVAL

Option: 2 seconds to 8h 59min 59sec

Press Off to enable manual logging.

<b>Logging Interval</b> Enter the data logging interval.  <div style="display: flex; justify-content: center; gap: 20px;"> <div style="text-align: center;"> <div style="background-color: black; color: white; padding: 2px 5px;">0</div>             hours           </div> <div style="text-align: center;"> <div style="padding: 2px 5px;">0</div>             minutes           </div> <div style="text-align: center;"> <div style="padding: 2px 5px;">2</div>             seconds           </div> </div> Press Next to move to the next entry.				
Accept	Escape	Delete Digit	Next	Off

### 7.2.3. STABILITY CRITERIA

Option: Fast, Medium, Accurate

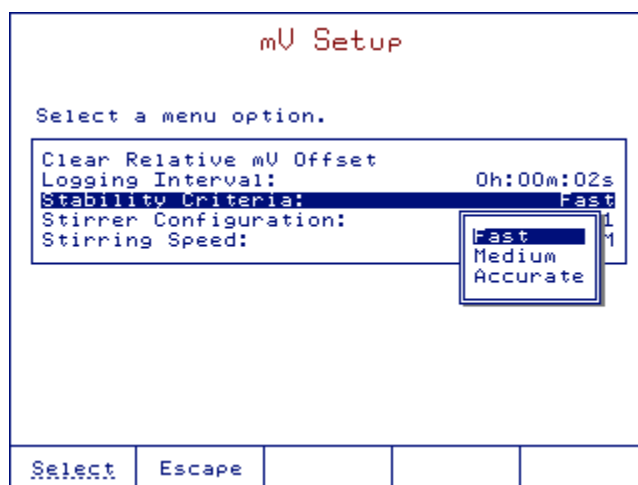

**Fast** Quicker results, less accuracy

**Medium** Medium speed results, medium accuracy

**Accurate** Slower results, high accuracy

### 7.2.4. STIRRER CONFIGURATION

Option: Stirrer 1, Stirrer 2 (if available), Disabled

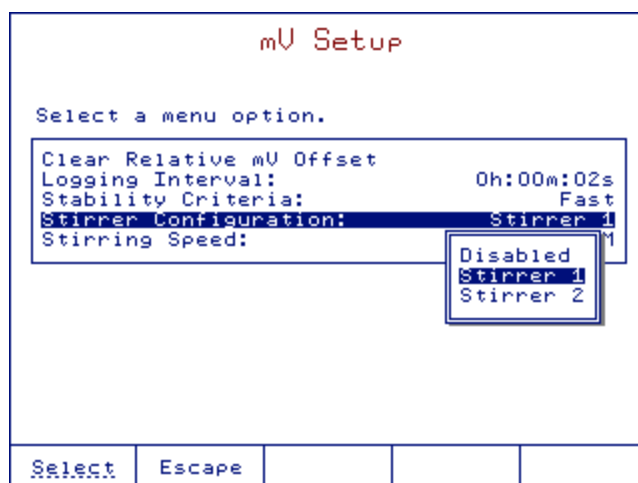

### 7.2.5. STIRRING SPEED

Option: 200 to 2500 RPM

Stirring Speed				
Enter the speed of the stirrer within below range.				
1100 RPM				
The range is from 200 to 2500 RPM.				
Accept	Escape	Delete Digit		

### 7.3. RELATIVE mV CALIBRATION

Relative mV				
Analog 1				
Set the value for the relative mV offset.				
Absolute mV: 2.7 mV				
Stirrer 1 1100/1100 RPM				
Relative mV: 2.7 mV				
Low limit: -1997.3 mV				
High limit: 2002.7 mV				
Accept	Escape	Delete Digit		

Accepts the value.

Cancels this operation and return to the previous screen.

Deletes the last digit.

### 7.4. LOGGING

Data logging is available in mV mode. It can be logging on demand (Manual Logging) or automatically (Interval Logging) at predefined time intervals.

The the logging report can be customized. See [9.3.5. SETTING UP pH / mV / ISE REPORT](#) section for more information.

#### 7.4.1. INTERVAL LOGGING

The logging interval is set in the mV Setup screen.

Press  to start the log.

The logging interval and name of logging file will be displayed on the measure screen.

To stop the automatic logging, press Stop.

#### 7.4.2. MANUAL LOGGING

To manually log mV readings, press  from the mV measurement screen.

A new record will be added to the report every time  is pressed.



## 8. ISE MODE

By pressing  from the main screen, the Titrator can be switched to **Titration**, **pH**, **mV** or **ISE** modes.

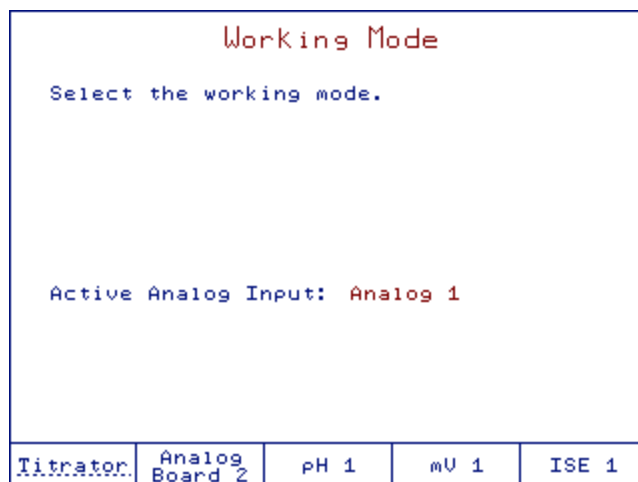

When one of these keys is pressed, the titrator will enter the selected mode:

Switches to **Titration** mode.

or  Switches the Analog Input for **pH**, **mV** and **ISE** mode (if second analog board is installed).

or  Switches to **pH** mode.

or  Switches to **mV** mode.

or  Switches to **ISE** mode.

## 8.1. DISPLAY

The ISE screen is shown below.

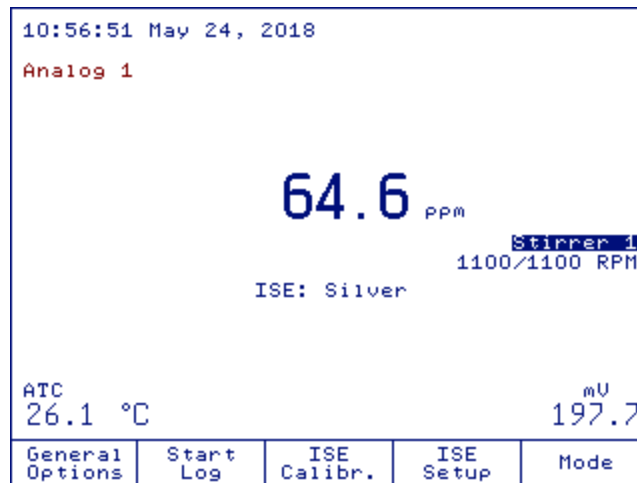

If one of these keys is pressed, the associated function is immediately performed. Some of the keys are active only in specific screens:

 Gives access to options that are not directly related to the measurement process. See [3. GENERAL OPTIONS](#) section for more information.

 Stores the current concentration reading. See [8.4. LOGGING](#) section for more information.

OR

 Starts the interval log. See [8.4. LOGGING](#) section for more information.

 Enters the ISE calibration screen. See [8.3. ISE CALIBRATION](#) section for more information.

 Enters the ISE setup screen. Parameters are associated with ISE measurements and calibration.

 Allows the user to switch between measurement modes: **Titration**, **pH**, **mV** and **ISE** mode.

## 8.2. ISE SETUP

To access the ISE Setup, press  option key in ISE mode.

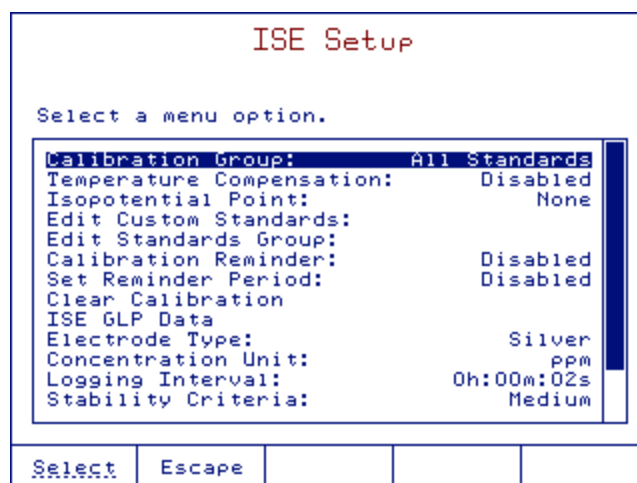

### 8.2.1. CALIBRATION GROUP

Option: All Standards or Standards Group



**All Standards** Includes both standard and custom solutions.

**Standards Group** Includes only the standards selected by the user.

### 8.2.2. TEMPERATURE COMPENSATION

Option: Enabled or Disabled

*Note: When Temperature compensation is enabled, the isopotential point must also be set.*

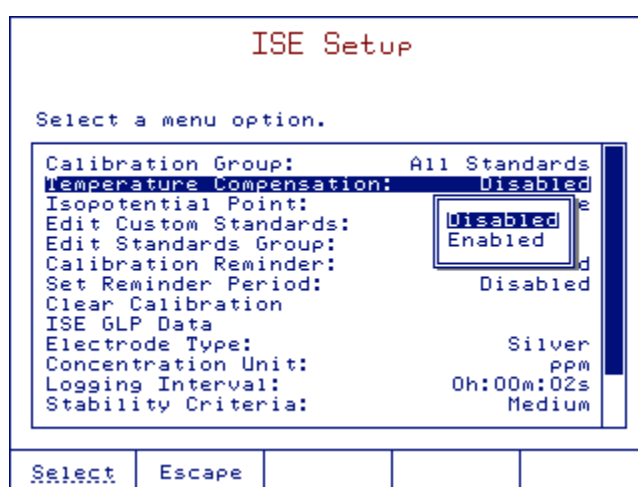

### 8.2.3. ISOPOTENTIAL POINT (TEMPERATURE COMPENSATION)

Option: 1.00 E<sup>-2</sup> to 1.00 E<sup>+5</sup> ppm

This option allows the user to set an isopotential point for the selected electrode when temperature compensation is enabled. The isopotential point is edited in ppm units only. The isopotential point will vary for different electrodes, if measurements are going to be made at several temperatures, the value should be entered if it is known.

Isopotential Point

Enter the value for isopotential point.

20.0 ppm

Low limit: 1.00E-2 ppm  
High limit: 1.00E+5 ppm

Accept	Escape	Delete Digit		Exponent
--------	--------	-----------------	--	----------

### 8.2.4. EDITING CUSTOM STANDARDS

Option: Up to five

Edit Custom Standards

Press <Edit> to edit selected standard.  
Press <Remove Standard> to delete the custom standard.

Use arrows keys to select the standard.

Remove Standard	Escape	Edit	◀	▶
--------------------	--------	------	---	---

1. Use the ◀ and ▶ keys to select the standard.
2. Press Remove Standard to delete the standard.
3. Press Edit to edit the selected custom standard; use the numeric keys to edit the standard.

### 8.2.5. EDITING STANDARD GROUP

Option: Up to 5 standards

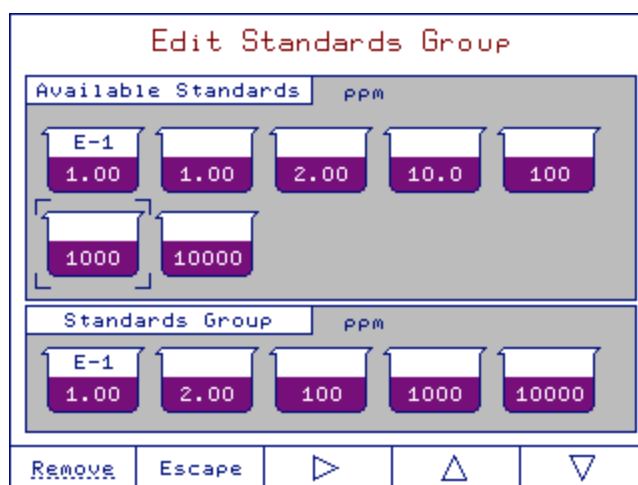

Use the arrow keys to select the standard to be included in / removed from the standard group.

or  Adds or removes the selected standard to / from standard group.

Returns to ISE Setup menu.

### 8.2.6. CALIBRATION REMINDER

Option: Daily, Periodic, Disabled

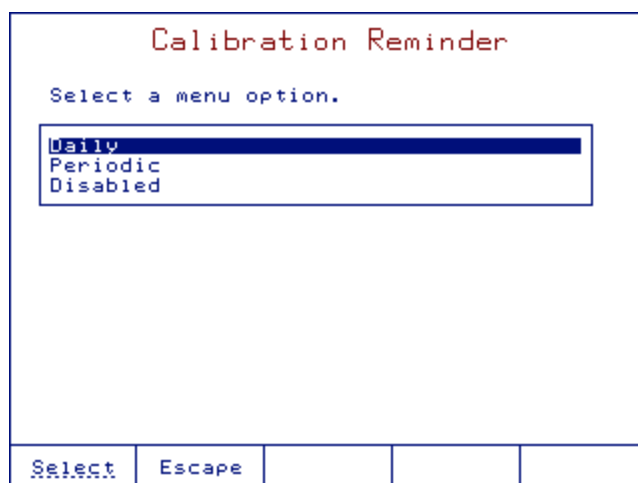

**Daily** The calibration reminder will appear daily, at specified time.

**Periodic** The calibration reminder will appear after the set time since the last calibration has elapsed.

**Disable** The calibration reminder will not appear.

### 8.2.7. SETTING REMINDER

If Daily or Periodic option was selected for the calibration reminder, the reminder period must also be set.

For a daily reminder, the time of day can be set.

For a periodic reminder period the number of days, hours and minutes can be set.

Periodic Calibration Reminder				
Enter the time period that must be passed since the last calibration, whereafter the calibration reminder appears.				
10 days	2 hours	30 minutes		
Press Next to move to the next entry.				
Accept	Escape	Delete Digit	Next	Off

Moves the cursor to the next field.

Saves the changes or  to return to the previous screen.

Disables the calibration reminder and return to ISE setup menu.

### 8.2.8. CLEARING CALIBRATION

This option clears the existing ISE calibration. If the calibration is cleared, a new calibration must be done in order to take measurements.

Clears the previous calibration or  to return to the previous screen.

Clear Calibration				
Press <Clear> to clear all calibration points.				
Press <Escape> to return without clearing the calibration points.				
Clear	Escape			

### 8.2.9. ISE GLP DATA

Displays the ISE calibration data

ISE GLP Data				
Analog 1				
Last Calibration:		13:42 May 24, 2018		
Slope: 100.8%		ISE: Silver		
Isopotential Point: 20.0 ppm				
1.00E-1 ppm,	0.1mV	28.1°C	A	
		13:39:43 May 24, 2018		
1.00 ppm,	59.5mV	28.1°C	A	
		13:40:39 May 24, 2018		
2.00 ppm,	77.6mV	28.1°C	A	
		13:41:25 May 24, 2018		
10.0 ppm,	120.0mV	28.1°C	A	
		13:41:45 May 24, 2018		
100 ppm,	181.0mV	28.2°C	A	
		13:42:17 May 24, 2018		
Escape				

### 8.2.10. ELECTRODE TYPE

Option: Ammonia, Bromide, Cadmium, Calcium, Carbon Dioxide, Chloride, Cupric, Cyanide, Fluoride, Iodide, Lead, Nitrate, Potassium, Silver, Sodium, Sulfate, Sulfide, five custom electrodes

Electrode Type				
Select a menu option.				
Ammonia Bromide Cadmium <b>Calcium</b> Carbon Dioxide Chloride Cupric Cyanide Fluoride Iodide Lead Nitrate Potassium Silver				
Select	Escape	View	Page Up	Page Down

**View** See the ion constants (name, molar weight, electric charge / slope).

**Escape** Returns to the setup screen.

Ion Constants				
View Ion constants.				
Name: Silver Molar Weight: 107.868 g/mol Electric Charge / Slope: 1 / 59.16				
Escape				

The Ion Constants for Custom Electrodes can be modified.

## 8.2.10.1. Name

Option: up to 10 characters

Electrode Name												
Select the highlighted letter by using the arrow keys then press "Enter". Select the empty field for a space. Press Accept to save the entire name.												
█	A	B	C	D	E	F	G	H	I	J	K	L
M	N	O	P	Q	R	S	T	U	V	W	X	Y
Z	a	b	c	d	e	f	g	h	i	j	k	l
m	n	o	p	q	r	s	t	u	v	w	x	y
z	ā	â	ā	ā	ā	ā	ā	ā	ā	ā	ā	ā
ō	ō	ō	ō	ō	ō	ō	ō	ō	ō	ō	ō	ō
ā	ā	ā	ā	ā	ā	ā	ā	ā	ā	ā	ā	ā
ū	ū	ū	ū	ū	ū	ū	ū	ū	ū	ū	ū	ū
0	1	2	3	4	5	6	7	8	9	%	.	,
?	!	(	)	[	]	<	>	=	/	+	-	'
Custom1 █												
Accept	Escape	Delete Letter	Cursor Left	Cursor Right								

## 8.2.10.2. Molar Weight

Option: 0.001 g / mol to 1000.000 g / mol

Ion Molar Weight				
Set the value for Ion molar weight.				
█ 10.000 g/mol				
Low limit: 0.001 g/mol				
High limit: 1000.000 g/mol				
Accept	Escape	Delete Digit		

## 8.2.10.3. Electric Charge / Slope

Option: 2 / 29.58, 1 / 59.16, -1 / -59.16, -2 / -29.58 or None / -59.16

Electric Charge / Slope									
Select the option.									
<table border="1" style="width: 100%;"> <tr> <td>2 / 29.58</td> </tr> <tr> <td>1 / 59.16</td> </tr> <tr> <td style="background-color: black; color: white;">-1 / -59.16</td> </tr> <tr> <td>-2 / -29.58</td> </tr> <tr> <td>None / -59.16</td> </tr> </table>					2 / 29.58	1 / 59.16	-1 / -59.16	-2 / -29.58	None / -59.16
2 / 29.58									
1 / 59.16									
-1 / -59.16									
-2 / -29.58									
None / -59.16									
Select	Escape								





## 8.2.14. ISE SIGNIFICANT DIGITS

Option: One (X), Two (XX), Three (XXX).

ISE Setup	
Select a menu option.	
Temperature Compensation:	Enabled
Isopotential Point:	20.0 ppm
Edit Custom Standards:	
Edit Standards Group:	
Calibration Reminder:	Disabled
Set Reminder Period:	Disabled
Clear Calibration	
ISE GLP Data	
Electrode Type:	
Concentration Unit:	Oh:0
Logging Interval:	
Stability Criteria:	
ISE Significant Digits:	XXX

Select	Escape			
--------	--------	--	--	--

## 8.2.15. STIRRER CONFIGURATION

ISE Setup	
Select a menu option.	
Isopotential Point:	None
Edit Custom Standards:	
Edit Standards Group:	
Calibration Reminder:	Disabled
Set Reminder Period:	Disabled
Clear Calibration	
ISE GLP Data	
Electrode Type:	Custom1
Concentration Unit:	PPM
Logging Interval:	Disabled
Stability Criteria:	Medium
ISE Significant Digits:	XXX
Stirrer Configuration:	Stirrer 1

Select	Escape			
--------	--------	--	--	--

## 8.2.15.1. Stirrer Option

Option: Disabled, Stirrer 1, Stirrer 2 (if installed)

Stirrer Configuration	
Select a menu option.	
Stirrer Option:	Stirrer 1
Stirring Speed:	

Disabled
Stirrer 1
Stirrer 2

Select	Escape			
--------	--------	--	--	--

### 8.2.15.2. Stirring Speed

Option: 200 to 2500 RPM

<b>Stirring Speed</b>				
Enter the speed of the stirrer within below range.				
1100 RPM				
The range is from 200 to 2500 RPM.				
Accept	Escape	Delete Digit		

## 8.3. ISE CALIBRATION

It is recommended to calibrate the instrument frequently if high accuracy is required. The instrument should also be recalibrated whenever the “Calibrate Electrode” message appears on the LCD.

Due to electrode conditioning time, the electrode must be immersed for several seconds to stabilize. The user will be guided step by step during calibration with easy-to-follow messages on the display. This will make the calibration a simple and error-free procedure.

### Preparation

Pour small quantities of the standard solution into clean beakers. If possible, use plastic beakers to minimize any EMC interferences.

For accurate calibration and to minimize cross-contamination, use two beakers for each standard solution: one for rinsing the electrode and one for calibration.

**Note:** For accurate measurements, add the appropriate ISA (Ionic Strength Adjustment) to the calibration standards.

### Calibration procedure

Before calibrating, make sure that the electrode type and concentration unit has been selected in ISE Setup.

Up to a five-points calibration is possible using any combination of five standard solutions and five custom solutions. The ISE calibration and measurement can be performed with or without temperature compensation. If the temperature compensation option is enabled, the isopotential point of the electrode must be set in ISE Setup.

1. Press  from the main screen. If the instrument was calibrated before and the calibration was not cleared, the old calibration can be cleared by pressing .
2. Immerse the ISE and the temperature probe approximately 2 cm into the standard with the lowest concentration.
3. Select the standard concentration with  or .
4. When the reading has stabilized, press  to update the calibration. The calibration point value will be added to the Calibrated Standard list.
5. Select  and repeat the procedure with all of the available standards.
6. Press  to exit the calibration.

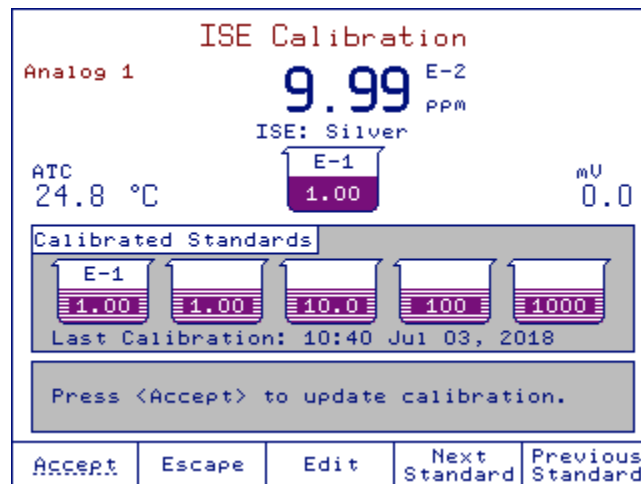

## 8.4. LOGGING

Data logging is available in ISE mode. It can be logging on demand (Manual Logging) or automatically (Interval Logging) at predefined time intervals.

The the logging report can be customized. See [9.3.5. SETTING UP pH / mV / ISE REPORT](#) section for more information.

### 8.4.1. INTERVAL LOGGING

The logging interval is set in the ISE Setup screen.

Press  to start the log.

The logging interval and name of logging file will be displayed on the measure screen.

To stop the automatic logging, press Stop.

### 8.4.2. MANUAL LOGGING

To manually log pH readings, press  from the ISE measurement screen.

A new record will be added to the report every time  is pressed.

## 9. AUXILIARY FUNCTIONS

### 9.1. BURETTE

To access the **Burette** screen, press **Burette** from the main titration screen.  
Highlight the desired option and then press **Select**.

Burette								
Select a menu option.								
<table border="1"> <tr> <td>Prime Burette</td> </tr> <tr> <td>Rinse Tip</td> </tr> <tr> <td>Manual Dispense</td> </tr> <tr> <td>Purge Burette</td> </tr> </table>					Prime Burette	Rinse Tip	Manual Dispense	Purge Burette
Prime Burette								
Rinse Tip								
Manual Dispense								
Purge Burette								
The current pump is: Pump 1 Current burette volume is 5 mL.								
Select	Escape	Choose Pump	Perist.1 On	Perist.2 On				

**Choose Pump** Allows you to select the desired pump for burette operations (it is only active if two pumps are connected).

Pump Settings						
Select the current pump.						
<table border="1"> <tr> <td>Pump 1</td> </tr> <tr> <td>Pump 2</td> </tr> </table>					Pump 1	Pump 2
Pump 1						
Pump 2						
Select	Escape					

### 9.1.1. PRIMING THE BURETTE

#### Option: Up to 5

The *Prime Burette* option is used to fill the burette with titrant or reagent before starting a titration. The priming process consists of several cycles of filling and emptying the burette with titrant.

Two rinse cycles are shown in the figure below. The dispensing tube is connected on the right side and the aspiration tube on the left side.

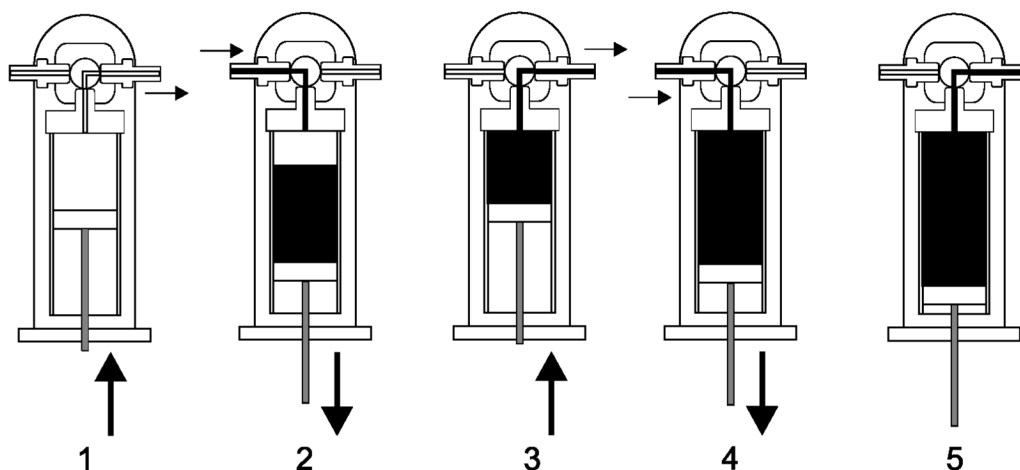

**Note:** Before starting this operation, the aspiration tube must be inserted in the titrant bottle. A waste container should be placed under the dispensing tip to collect the waste solution.

To prime the burette, select Prime Burette, enter the number of rinses and press .

We recommend at least three rinses to assure that the air bubbles are completely removed.

Total Burette Rinses				
Enter the total number of burette rinses.				
<div style="border: 1px solid black; display: inline-block; padding: 2px 10px;">3</div>				
A minimum of three rinses is recommended.				
Accept	Escape	Delete Digit		

### 9.1.2. RINSING BURETTE TIP

A 2 mL dose of titrant will be dispensed from the burette when this operation is selected, this will eliminate any air in the dispensing tip.

### 9.1.3. MANUAL DISPENSE

*Manual Dispense* option allows a defined titrant volume to be dosed. Select the *Manual Dispense* option and press

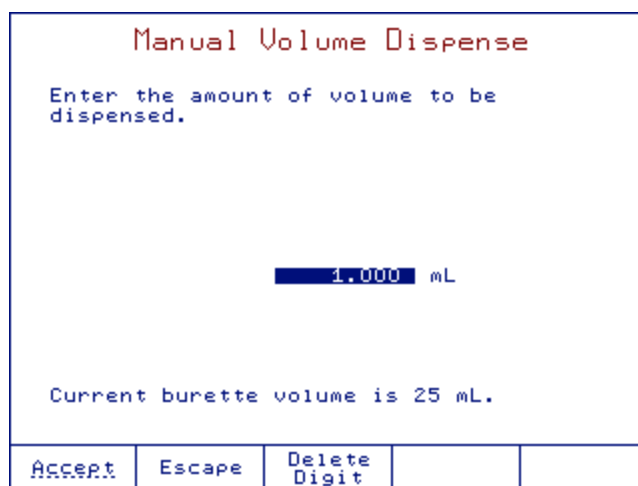

Use the numeric keypad to enter the volume to be dispensed.

The manual dispense volume must be between the limits shown below:

5 mL burette 0.001 to 4.750 mL

10 mL burette 0.001 to 9.500 mL

25 mL burette 0.005 to 23.750 mL

50 mL burette 0.005 to 47.500 mL

### 9.1.4. PURGING THE BURETTE

This option allows the burette to be emptied before cleaning or storing the burette. The burette is flushed twice.

**Note:** Before starting this operation, remove the aspiration tube from the titrant bottle.

The figures below show the steps in a purge burette operation.

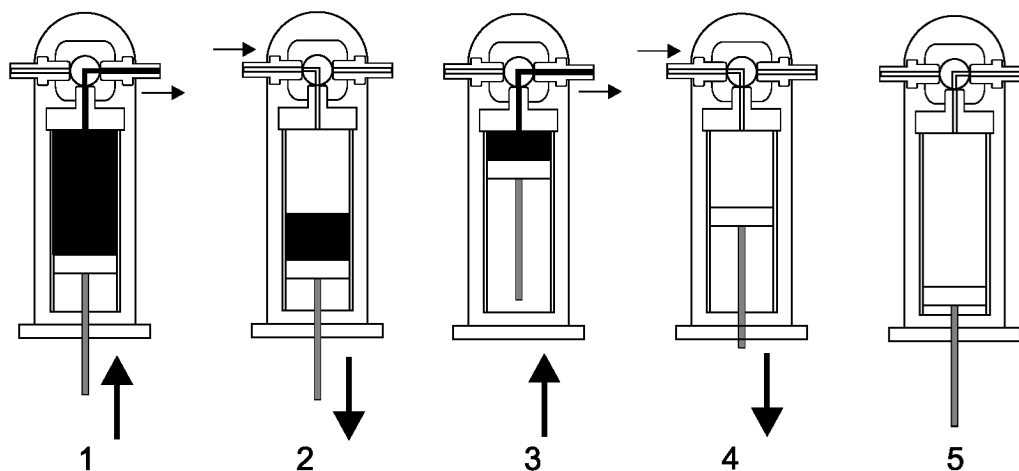

### 9.1.5. PERISTALTIC PUMP

To manually control the peristaltic pump, press **Burette** from the main titration screen.

**Perist.1 On** or **Perist.2 On** Turns on the selected peristaltic pump.

**Perist.1 Off** or **Perist.2 Off** Turns off the selected peristaltic pump.

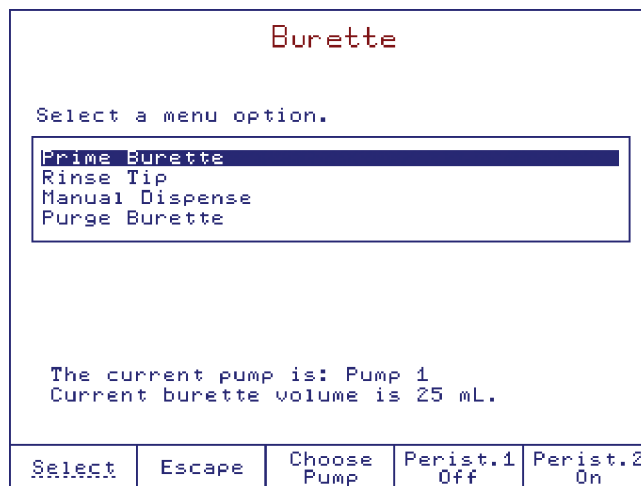

**Note:** If the peristaltic pump is not turned off, it will turn off automatically after 10 minutes.

### 9.2. STIRRER

The stirrer can be turned on and off by pressing **stir**.

During the titration process, the stirring speed can be manually adjusted using the **▲** and **▼** keys.

### 9.3. RESULTS

From the **Data Parameters** screen, you can access the following options:

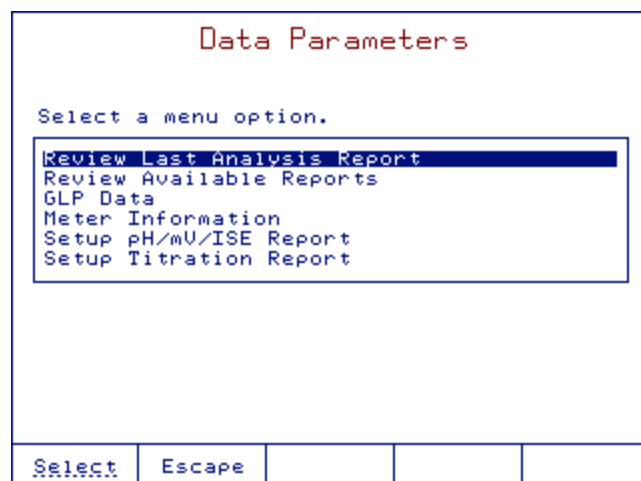



### 9.3.1. REVIEWING LAST ANALYSIS REPORT

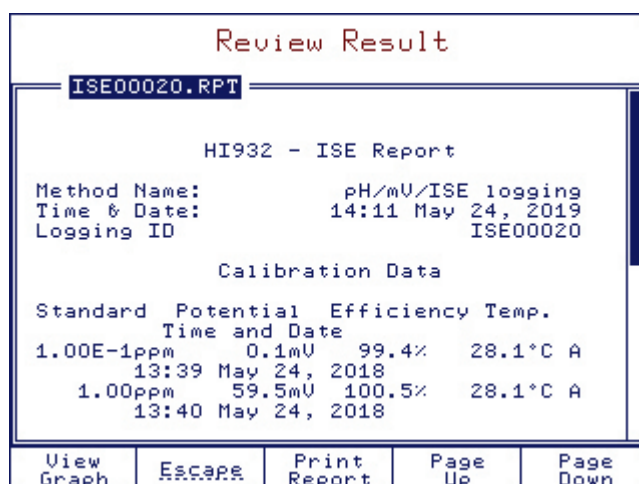

The report contains information based on the selections made in the **Setup Titration Report** and **Setup ISE / pH / mV Report** screen.

- Review the graph.
- Print the titration report.
- Return to the previous screen.
- Scroll through the pages.

### 9.3.2. REVIEWING AVAILABLE REPORTS

Up to 100 reports can be saved on the titrator. To view one of the saved reports, highlight a report and then press .

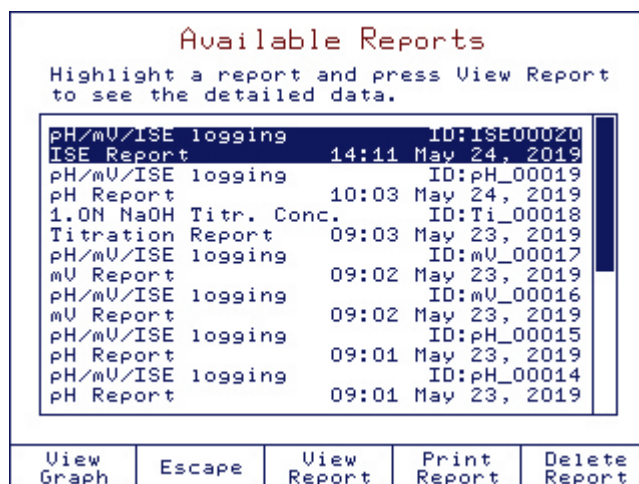

The report contains only the information selected in the **Setup Titration Report** and **Setup pH / mV / ISE Report** screens during report configuration.

- Review the selected graph.
- Review the selected report.
- Print the selected report.
- Delete the selected report.
- Return to the previous screen.

### 9.3.3. GLP DATA

Option: Up to 20 characters

GLP Data

Select a menu option.

Sample Name:
Company Name:
Operator Name:
Electrode Name:
Field 1:
Field 2:
Field 3:

Select	Escape			
--------	--------	--	--	--

**Sample Name** Allows the sample name to be recorded in each report. The sample name will increase by one, with each new titration or logging report, if the last character is a number.

**Company Name** Allows the company name to be recorded in each report.

**Operator Name** Allows the operator name to be recorded in each report.

**Electrode Name** Allows the electrode name to be recorded in each report.

**Fields 1, 2, 3** Allows any additional information to be recorded in each report.

The fields must be selected from **Setup Titration Report** screen in order to be displayed in the titration report.

See [9.3.6. SETTING UP TITRATION REPORT](#) section for more information.

### 9.3.4. METER INFORMATION

Displays titrator configuration data.

```

Meter Information
SERIAL NUMBER 932 Titrator
Titrator Serial Number:      12133404404
Analog Board1 Serial Number: 30134202202
Analog Board2 Serial Number: 30000000000
Pump 1 Serial Number:        70094513513
Stirrer 1 Serial Number:     70091703703

SOFTWARE VERSION
Titrator Software Version:    v1.00
Base Board Software Version:  v1.00
Pump 1 Software Version:      v1.00
Stirrer 1 Software Version:   v1.00

Analog 1 Calibration Date:    May 22, 2018
Analog 2 Calibration Date:    May 10, 2018

```

	Escape	Print		
--	--------	-------	--	--

<b>Titrator Serial Number</b>	The serial number of the titrator base board.
<b>Analog Board 1 (or 2) Serial Number</b>	The serial number of the analog board.
<b>Pump 1 (or 2) Serial Number</b>	The serial number of the connected pump.
<b>Titrator Software Version</b>	The current software version installed on the titrator.
<b>Base Board Software Version</b>	The current software version present on the base board of the titrator.
<b>Pump 1 (or 2) Software Version</b>	The current software version for the pump.
<b>Analog 1 (or 2) Calibration Date</b>	Manufacturer calibration date of the analog board.

**Note:** If more than 1 year elapsed from the calibration date of the analog board 1 or 2, the message “Analog 1 Calibration Due or Analog 2 Calibration Due” will appear on the main screen. The analog board(s) need to be recalibrated.

### 9.3.5. SETTING UP pH / mV / ISE REPORT

Customize a unique report to record the pH, mV, and ISE measurements. An asterisk means that it will be included in the report.

```

Setup pH/mV/ISE Report

Select fields to be saved in the report.

* Result and Units
* Potential
* Temperature and Units
* Date and Time
* Calibration Data
Sample Name
Company Name
Operator Name
Electrode Name
Field 1
Field 2
Field 3
Software Versions
Serial Numbers

Select  Escape  Save Report  Page Up  Page Down
  
```

- Select Adds the highlighted information to the report.
- Unselect Removes the highlighted information from the report.
- Escape Returns to the Data Parameter Screen. Report is not updated.
- Save Report Updates the report with the selected items. Report previously saved will not be updated.
- Page Up Page Down Scrolls through the options.

### 9.3.6. SETTING UP TITRATION REPORT

Customize a unique report to record the titration results. An asterisk means that it will be included in the titration report.

```

Setup Titration Report

Select fields to be saved in the report.

* Result and Units
* Titration Method
* Initial and Final Readings
* Analyte Size
* End Point Volume
* Titration Duration
* Date and Time
* Titration Ended By
All Data Points
Method Parameters
Calibration Data
Sample Name
Company Name
Operator Name

Unselect  Escape  Save Report  Page Up  Page Down
  
```

- Select Adds the highlighted information to the report.
- Unselect Removes the highlighted information from the report.
- Escape Returns to the Data Parameter Screen. Report is not updated.
- Save Report Updates the report with the selected items. Report previously saved will not be updated.
- Page Up Page Down Scrolls through the options.

## 10. MAINTENANCE & PERIPHERALS

The 25-mL burette included with the titrator exceeds the ISO 8655 standard for accurate delivery of liquids by a motor-driven piston burette.

### 10.1. BURETTE MAINTENANCE

#### 10.1.1. BURETTE ASSEMBLY

The burette is delivered with a 25-mL syringe inside and with all of the accessories mounted. See **1. SETUP** section for more information. The burette assembly consists of a rigid housing which holds the glass syringe, a 3-way valve and titrant tubing.

#### 10.1.2. CHANGING THE BURETTE

Remove the burette from the pump assembly by sliding it forward and then slide the new burette into place.

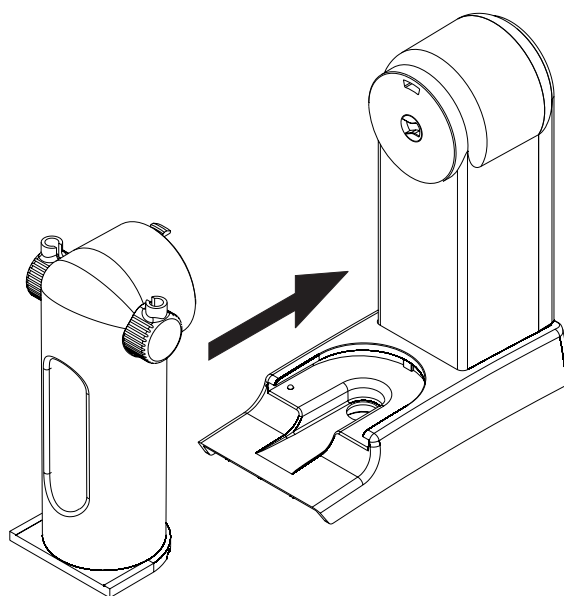

#### 10.1.3. DISASSEMBLING THE BURETTE

The aspiration and the dispensing tubes have fittings and tube protectors. The aspiration tube is mounted on the left side and the dispensing tube is mounted on the right side of the burette.

To remove the dispensing tube and the aspiration tube follow these steps:

1. Remove the blue tube protector (A) by sliding it off the clear titrant tubing.
2. Remove the tube lock (B) from the burette holder.
3. Turn the fitting (C) counterclockwise to remove it from the burette holder.
4. Slide the clear titrant tubing through the fitting.

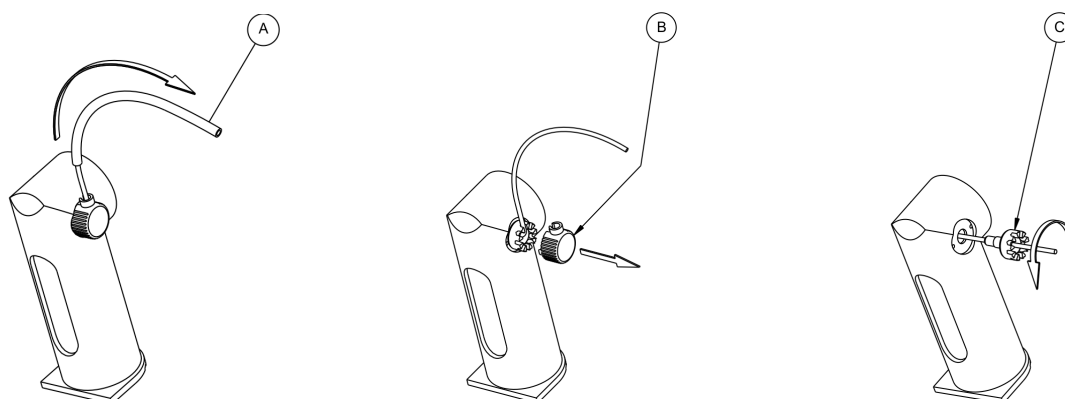

### 10.1.4. ASSEMBLING THE BURETTE

To attach the dispensing tube and the aspiration tube, follow these steps:

1. Insert the flat-shaped end of the titrant tubing into the valve outlet (A) and screw the fitting clockwise to tighten. The highest of the 9 cuts should be vertical in the final position.
2. Bend the tube up into the vertical position to enter the highest cut of the fitting (C).
3. Replace the tube lock fitting (D).
4. Replace the blue tube protector (E) by sliding it over the clear titrant tubing, the protector will sit in the tube lock fitting.

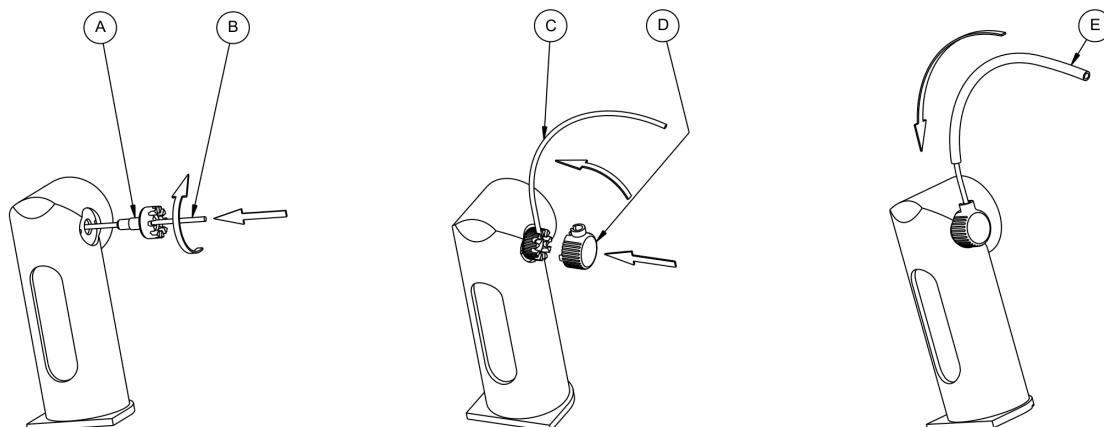

### 10.1.5. CLEANING THE BURETTE

To clean the burette, follow these steps:

1. If the burette is filled with titrant, remove the aspiration tube from the titrant bottle and purge burette. See [9.1.4. PURGING THE BURETTE](#) section for more information.
2. Insert the aspiration tube into cleaning solution, deionized water or titrant solvent.
3. Go through two cycles of filling and emptying the burette. See [9.1.4. PURGING THE BURETTE](#) section for more information.
4. During second cycle, remove the aspiration tube from the cleaning solution, deionized water or solvent and allow the air to replace the liquid in the burette. This will clean the aspiration tube.

If this simple cleaning procedure is not adequate, continue with these steps:

1. Remove the burette assembly from the pump.
2. Remove the dispensing and aspiration tubes. Clean them separately or insert new ones.
3. Remove the protective cap from the bottom of the burette assembly by using the burette removal tool.
4. Remove the syringe from the burette assembly by unscrewing it with your fingers.
5. Extract the piston from the syringe.
6. Clean both the piston and the syringe with appropriate cleaning solution. Rinse with deionized water.
7. Remove the excess liquid.

**Warning:** Avoid contacting the titrant with bare hands. Avoid spilling titrant. Clean the external side of the syringe and piston to remove aggressive chemicals. Do not touch the white PTFE part of the piston or internal walls of the burette with bare hands or greasy materials.

8. Reinsert the piston into the syringe.
9. Reinsert the syringe by screwing it in the valve with your fingers.
10. Reinsert the protective cap to the bottom of the burette assembly. Carefully position the cap into the burette.
11. Slide the burette into the burette stand. Notice the position of the piston shaft to the pump couple.
12. Priming the burette three times with new titrant is recommended.

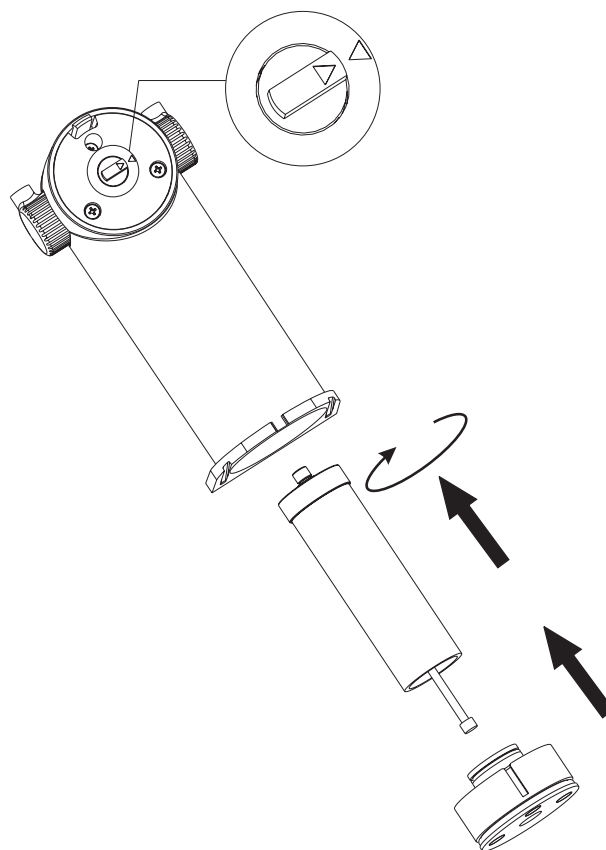

### 10.1.6. BURETTE PREPARATION (TITRANT FILLING)

Before starting a titration, the burette must be properly filled with titrant in order to obtain an accurate and repeatable result. To fill the burette, follow the next steps and recommendations:

1. If necessary, clean the burette and make sure it is empty.
2. From the main screen press .
3. Highlight *Prime Burette* option and press .
4. Enter the number of times the burette needs to be rinsed (minimum three rinses are recommend allowing air bubbles to be evacuated).
5. Press .

To avoid the presence of the air bubbles inside the burette, make sure to have a continuous liquid flow inside the burette. A little air just above the liquid level at the first filling is normal. The next filling will evacuate all of the air; no air will be left in the valve.

Sometimes during this process, slight finger tapping on the tubes helps remove any residual air bubbles.

If air bubbles are still present:

1. Remove the aspiration tube from the titrant bottle.
2. Repeat burette preparation procedure.
3. If this is not successful, clean the burette again.

## 10.2. PERIPHERALS

**Warning!** Connection or disconnection of POWER, PUMP ASSEMBLY, PRINTER, RS232 INTERFACE or AUTOSAMPLER must only be done when titrator and external devices are turned off.

### 10.2.1. CONNECTING TO A PRINTER

A variety of parallel printers can be connected to the parallel port of the titrator using a DB25 cable.

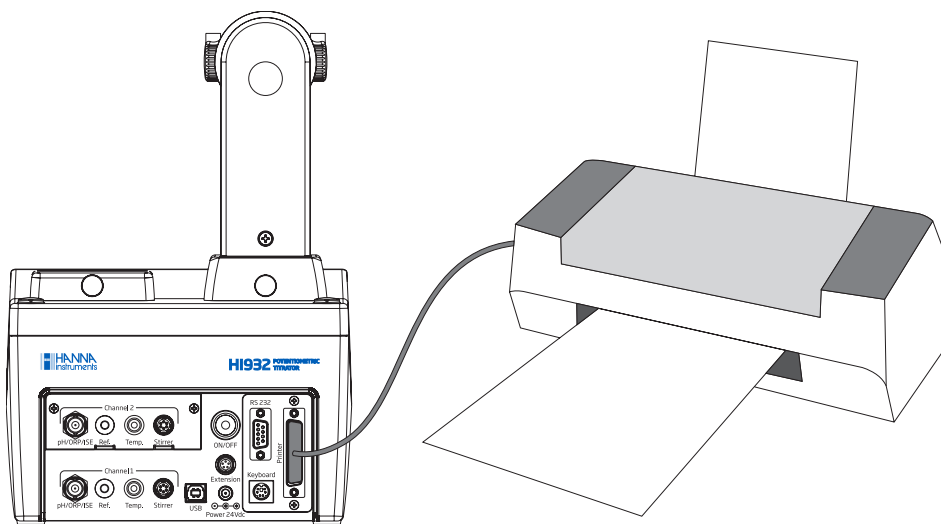

**Warning:** The titrator and the external printer must be both turned off before they are connected.





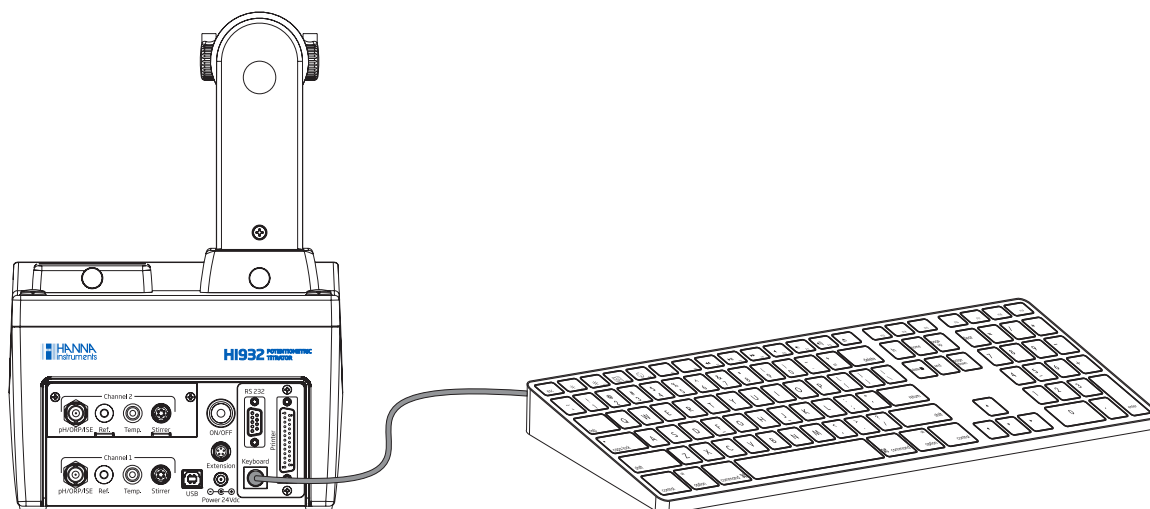







### 10.2.2. CONNECTING AN EXTERNAL PC KEYBOARD

This connection allows the use of an external PS/2 PC Keyboard in addition to the titrator's keypad.





The correspondence between the titrator's keypad and the United States 101-type external keyboard is detailed below:

External PC Keyboard (United States 101)	Titrator Keypad
Function key F-1	
Function key F-2	
Function key F-3	
Function key F-4	
Function key F-5	Option key 1 (from left to right)
Function key F-6	Option key 2 (from left to right)
Function key F-7	Option key 3 (from left to right)
Function key F-8	Option key 4 (from left to right)
Function key F-9	Option key 5 (from left to right)
Function key F-10	
Arrow key: Up	
Arrow key: Down	
Arrow key: Left	
Arrow key: Right	
Page Up	
Page Down	
Numeric keys: 0 to 9	
Enter	
Alphanumeric keys	Allow alphanumeric entries

### 10.2.3. CONNECTING TO A COMPUTER

The titrator can be connected to a computer using a USB cable. **HI900** PC application needs to be installed on the PC.

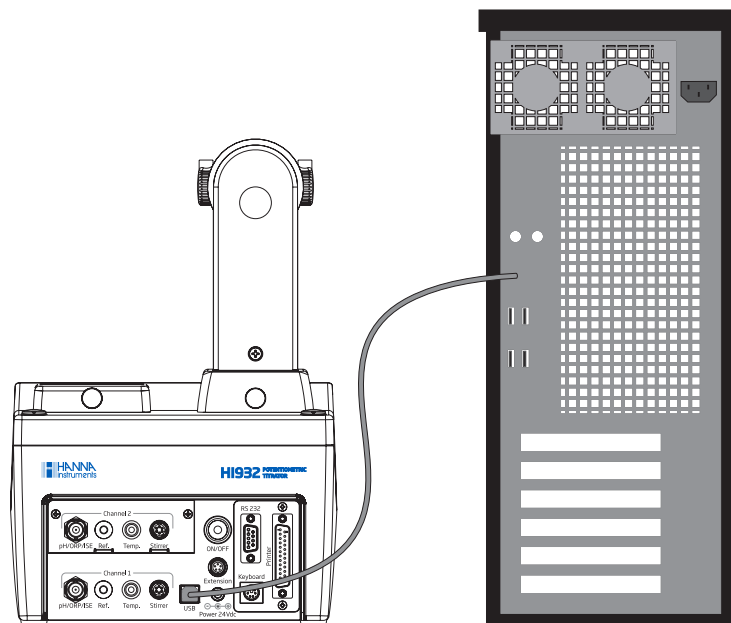

To connect the PC to the titrator follow the steps below:

1. Connect the cable to the USB port on the rear panel of the titrator.
2. Connect the cable to the USB port on the PC.

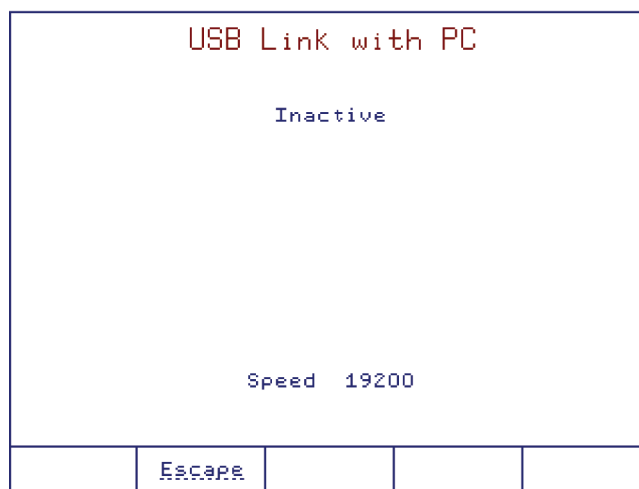

The **HI900** PC application allows the transfer of methods and reports between the titrator and PC. See **3.12. USB LINK WITH PC** section for more information.

## 11. AUTOSAMPLER

### 11.1. START UP

Once the instrument is assembled and installed, follow the steps below to start the titrator and access the autosampler.

1. Connect the titrator to a power outlet with the supplied power adapter.
2. Connect the autosampler to the titrator using the HI920-933 communication cable.
3. Turn on the autosampler then the titrator pressing the power switches located on the back of each instrument.
4. Wait until the titrator finishes the initialization process.
5. When prompted, press **device** to enter the autosampler interface.

The autosampler information screen will be displayed.

If the autosampler has not been detected, an **X** will appear over the autosampler symbol located in the top right corner.

**Note:** The autosampler can be accessed at any time from the titrator's main screen by pressing (device).

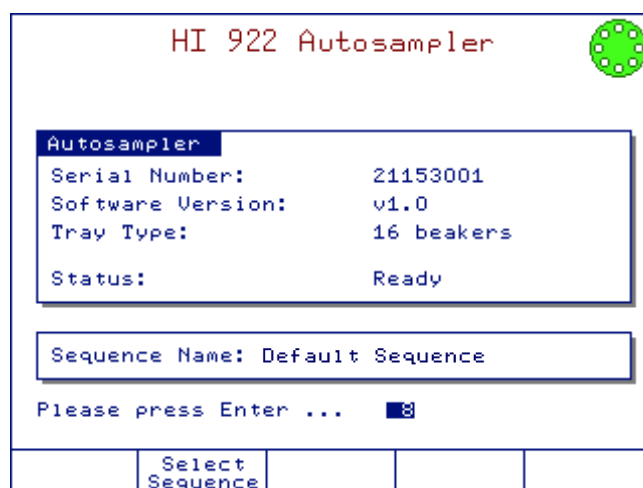
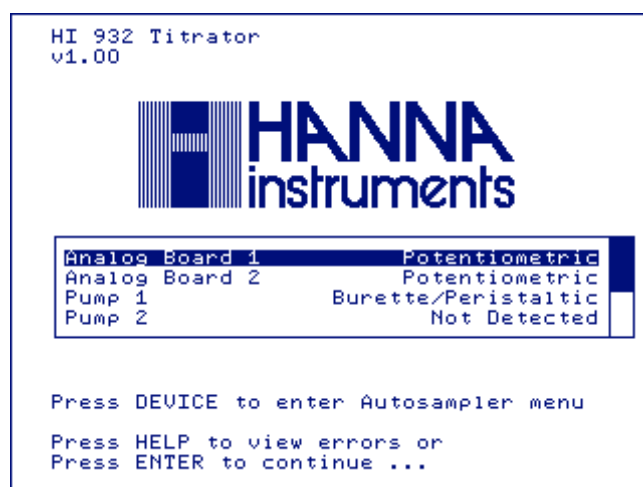

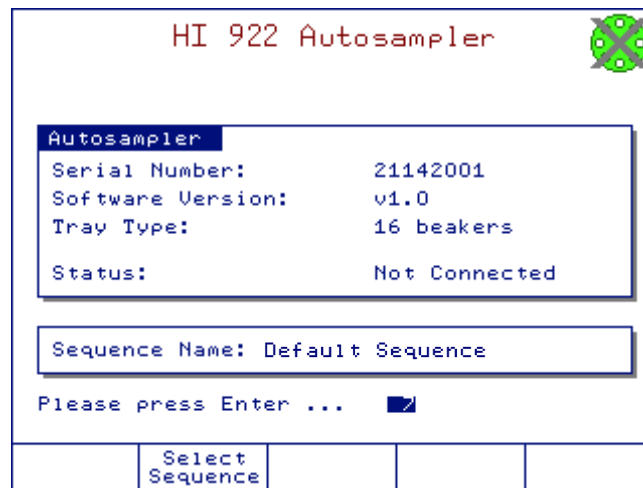

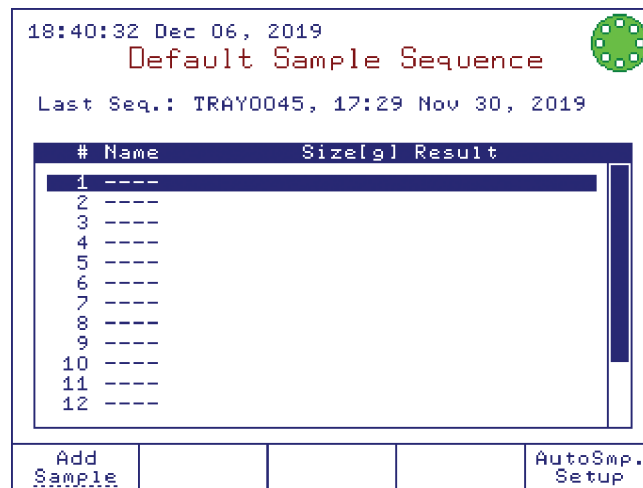

The sample table screen will be displayed.

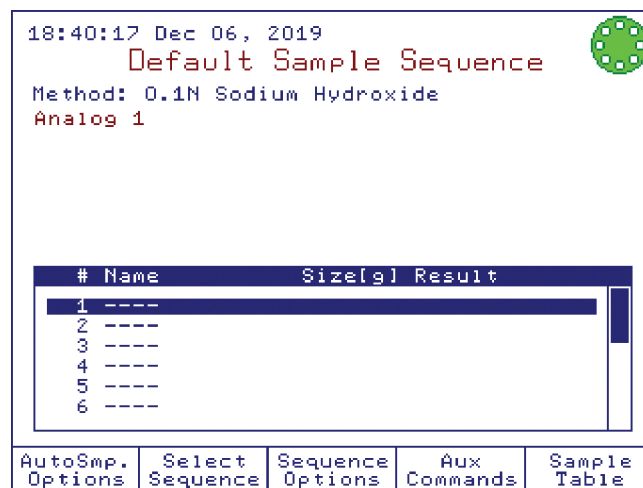

To view the autosampler's main screen press 



## 11.2. AUXILIARY COMMANDS

The auxiliary commands menu can be accessed from the main screen by pressing . From this screen you are able to calibrate your electrode and perform manual operations (i.e. running the pumps, moving the tray, etc.).

Use the  and  keys to select the analog input to be used for calibration.

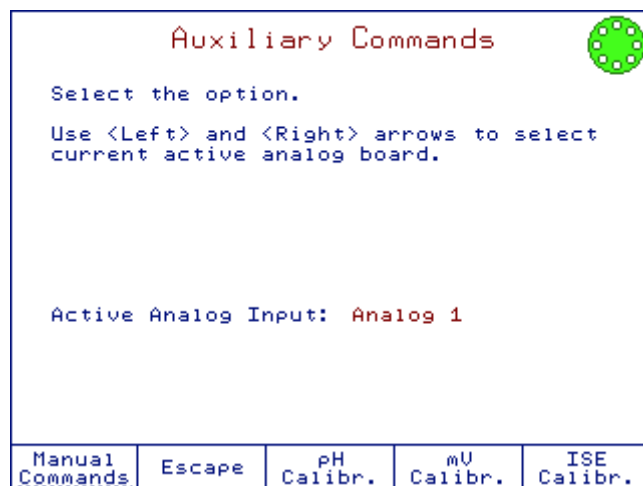

### 11.2.1. MANUAL COMMANDS

The manual commands screen is used to manually operate the autosampler dispenser, beaker position, auxiliary pumps, burette and stirrers.

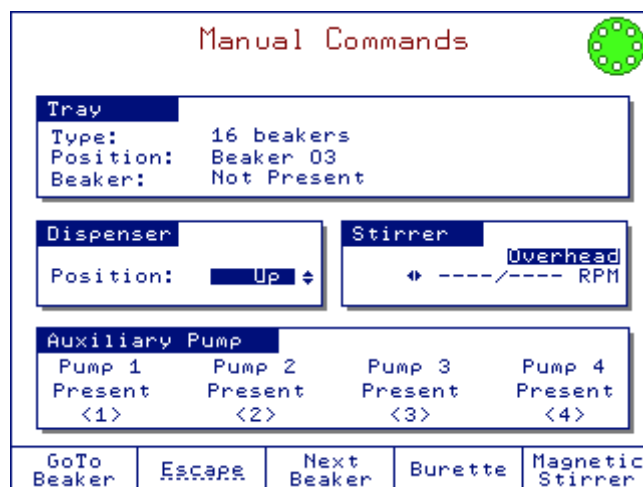

### 11.2.1.1. Tray

To move the tray use ,  or the  or  arrow keys on the autosampler keypad.

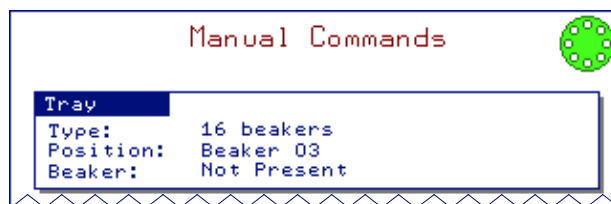

**Type** Is the tray size currently detected by the autosampler. The tray size can be manually selected, if necessary. See [11.3.6. TRAY TYPE](#) section for more information.

**Position** Refers to the beaker located under the dispenser.

**Beaker** Indicates the status (present or not present) of the beaker located under the dispenser. Beaker detection can be disabled, if necessary. See [11.3.7. BEAKER DETECTION](#) section for more information.

### 11.2.1.2. Dispenser



The position (up or down) of the dispensing head will be displayed.

To move the dispenser use the  and  keys on the autosampler or titrator keypad.



### 11.2.1.3. Stirrer

Use the  or  to toggle between the stirrer type.

Press  on the titrator keypad to turn on the stirrer. When active, use the  and  keys on the titrator keypad to change the stir speed.



### 11.2.1.4. Auxiliary Pumps

To run an active pump, press and hold the corresponding number key on the autosampler keypad or titrator keypad (e.g. press numeric key 1 for auxiliary pump 1, 2 for auxiliary pump 2, etc.).

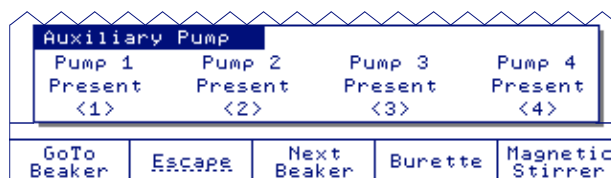

### 11.2.1.5. Burette

To access the Burette screen, press **Burette** from the manual commands screen. Highlight the desired option and then press **Select**. See [9.1. BURETTE](#) section for more information.

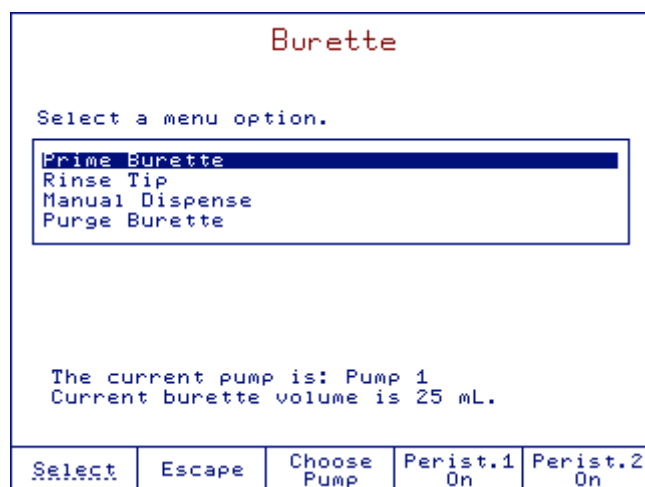

### 11.2.2. pH CALIBRATION

From the Auxiliary Commands screen, press **pH Calibr.** to view pH calibration screen. See [6.3. pH CALIBRATION](#) section for more information.

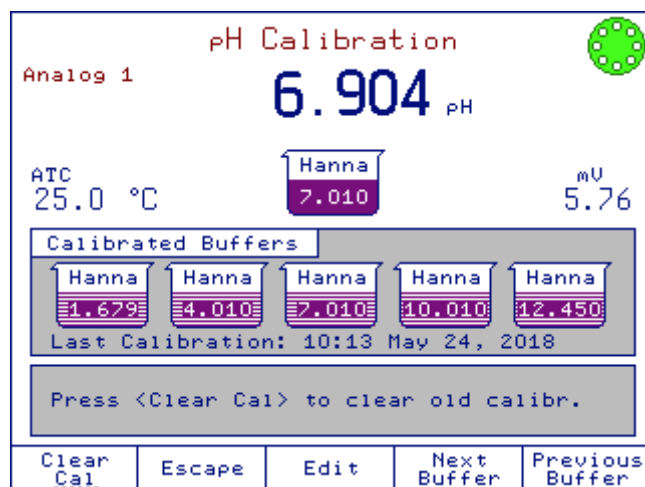

### 11.2.3. RELATIVE mV CALIBRATION

Press  to view mV calibration screen. See [7.3. RELATIVE mV CALIBRATION](#) section for more information.

Relative mV				
Analog 1				
Set the value for the relative mV offset.				
Absolute mV:	3.1	mV		
			Overhead	
			1400/1400 RPM	
Relative mV:	3.1	mV		
Low limit:	-1996.9	mV		
High limit:	2003.1	mV		
Accept	Escape	Delete Digit		

### 11.2.4. ISE CALIBRATION

Press  to view ISE calibration screen. See [8.3. ISE CALIBRATION](#) section for more information.

ISE Calibration				
Analog 1				
9.99		E-2		
		ppm		
ISE: Silver				
ATC	E-1		mV	
24.8 °C	1.00		0.0	
Calibrated Standards				
E-1				
1.00	1.00	10.0	100	1000
Last Calibration: 10:40 Jul 03, 2018				
Press <Accept> to update calibration.				
Accept	Escape	Edit	Next Standard	Previous Standard



### 11.3. AUTOSAMPLER OPTIONS

The Autosampler Options screen gives access to options that are not directly related to the autosampler sequences. To access this screen, press  from the autosampler main screen.

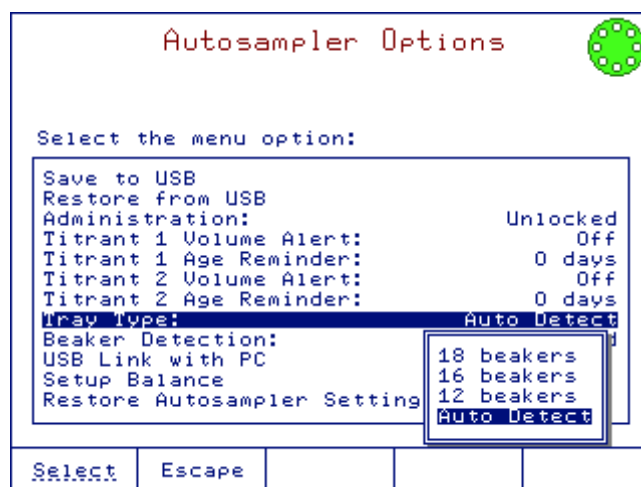

#### 11.3.1. SAVE TO USB

This option allows the user to save files from titrator to a USB storage device.

**Note:** Autosampler report files contain the individual titration reports for all samples run on that tray.

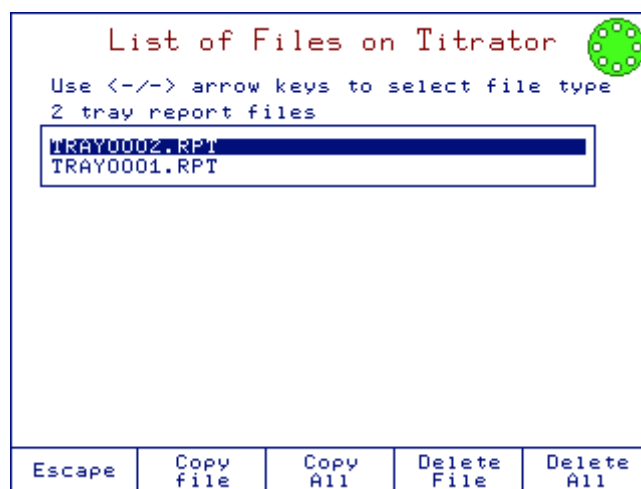

From the autosampler options, the available file types are:

<b>Standard method</b>	HIXXXXX.MTD (e.g. HI1001EN.MTD, HI1004EN.MTD)
<b>User-defined method</b>	USERXXXX.MTD (e.g. USER0001.MTD)
<b>Sequence</b>	SEQXXXX.MTD (e.g. SEQ0001.MTD)
<b>Autosampler report</b>	TRAYXXXX.RPT (e.g. TRAY0001.RPT)

Use the  and  keys to select the file type. The number of files and the file name on the titrator will be displayed.

Use the  and  keys to scroll through the list.

The option keys allow the following operations:

- Delete File Deletes the highlighted file.
- Delete All Deletes all currently displayed files.
- Copy File Copies the highlighted file from the titrator to a USB storage device.
- Copy All Copies all currently displayed files from the titrator to a USB storage device.
- Escape Returns to the **Autosampler Options** screen.

The status of the transfer (“Successful” or “Unsuccessful”) and the file name of the currently processed file are displayed during copying or deleting.

**Note:** The saved files will be stored on the USB storage device in the **HI932** Folder, as follows:

**Methods** USB Drive:\HI932\Methods\\*.mtd

**Sequences** USB Drive:\HI932\Sequence\\*.mtd

**Reports** USB Drive:\HI932\ASReport\\*.rpt

### 11.3.2. RESTORE FROM USB

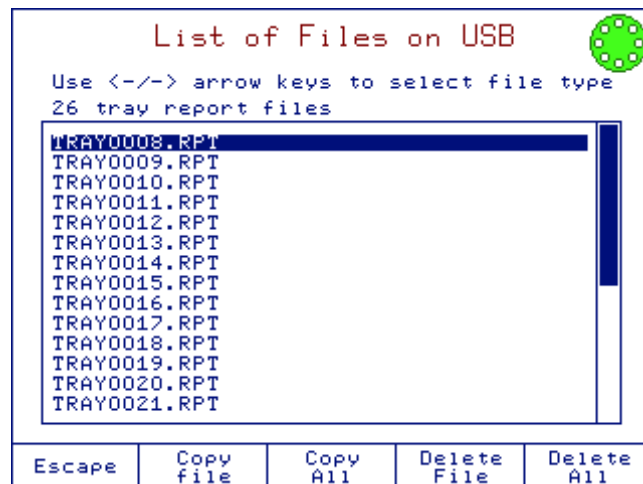

This screen allows the user to transfer files from a USB storage device to the titrator. The file types that can be transferred are:

**Standard Method** HIXXXYY.MTD (e.g. HI1001EN.MTD, HI1004EN.MTD)

**User-defined Method** USERXXX.MTD (e.g. USER0001.MTD)

**Sequence** SEQXXX.MTD (e.g. SEQ0001.MTD)

**Autosampler Report** TRAYXXX.RPT (e.g. TRAY0001.RPT)

**Note:** Autosampler report files contain the individual titration reports for all samples run on that tray.

Use the and keys to select the file type. The number of files and the file name on the titrator will be displayed.

Use the and keys to scroll through the list.

The option keys allow the following operations:

- Delete File Deletes the highlighted file.
- Delete All Deletes all currently displayed files.
- Copy File Copies the highlighted file from the titrator to a USB storage device.
- Copy All Copies all currently displayed files from the titrator to a USB storage device.
- Escape Returns to the **Autosampler Options** screen.

**Note:** The saved files will be stored on the USB storage device in the **HI932** Folder, as follows:

Methods USB Drive:\HI932\Methods\\*.mtd  
 Sequences USB Drive:\HI932\Sequence\\*.mtd  
 Reports USB Drive:\HI932\ASReport\\*.rpt

### 11.3.3. ADMINISTRATION

A 4-digit numeric PIN can be set to prevent unauthorized changes from being made. See [3.3. ADMINISTRATION](#) section for more information.

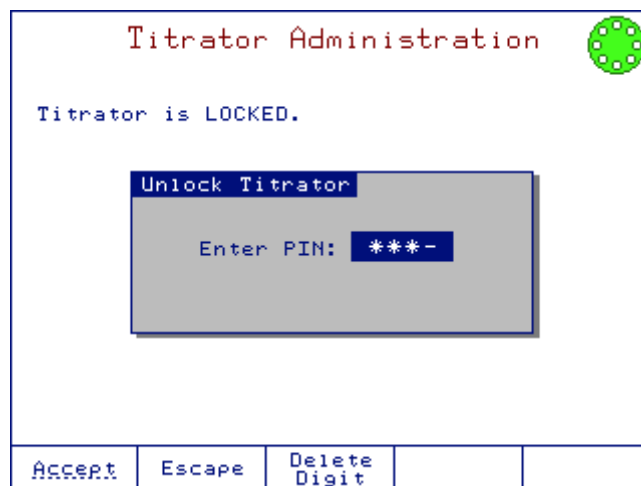

### 11.3.4. TITRANT VOLUME ALERT

This screen allows a programmable reminder to appear when the titrant reservoir is below 100 mL. The titrant volume will decrease as the titrant is used. See [3.10. TOTAL VOLUME ALERT](#) section for more information.



### 11.3.5. TITRANT AGE REMINDER

A programmable reminder will appear when it is time to verify the titrant concentration or to change the titrant. See 3.11. TITRANT AGE REMINDER section for more information.

Titrant 1 Age Reminder 				
Enter the number of days to pass since the last Titr. Vol. updating or the last Start pressing, whereafter the reminder appears.				
5 days				
The range is from 0 to 31 days.				
Start	Escape	Delete Digit		Off

### 11.3.6. TRAY TYPE

Option: Auto Detect, 18 beakers, 16 beakers, 12 beakers

The autosampler trays have a built in RFID tag that transmits the tray type and serial number directly to the titrator. The tray type can also be selected manually.

Autosampler Options 																														
Select the menu option:																														
<table border="1"> <tr> <td>Save to USB</td> <td></td> </tr> <tr> <td>Restore from USB</td> <td></td> </tr> <tr> <td>Administration:</td> <td>Unlocked</td> </tr> <tr> <td>Titrant 1 Volume Alert:</td> <td>Off</td> </tr> <tr> <td>Titrant 1 Age Reminder:</td> <td>0 days</td> </tr> <tr> <td>Titrant 2 Volume Alert:</td> <td>Off</td> </tr> <tr> <td>Titrant 2 Age Reminder:</td> <td>0 days</td> </tr> <tr> <td>Tray Type:</td> <td>Auto Detect</td> </tr> <tr> <td>Beaker Detection:</td> <td></td> </tr> <tr> <td>USB Link with PC</td> <td>18 beakers</td> </tr> <tr> <td>Setup Balance</td> <td>16 beakers</td> </tr> <tr> <td>Restore Autosampler Setting</td> <td>12 beakers</td> </tr> <tr> <td></td> <td>Auto Detect</td> </tr> </table>					Save to USB		Restore from USB		Administration:	Unlocked	Titrant 1 Volume Alert:	Off	Titrant 1 Age Reminder:	0 days	Titrant 2 Volume Alert:	Off	Titrant 2 Age Reminder:	0 days	Tray Type:	Auto Detect	Beaker Detection:		USB Link with PC	18 beakers	Setup Balance	16 beakers	Restore Autosampler Setting	12 beakers		Auto Detect
Save to USB																														
Restore from USB																														
Administration:	Unlocked																													
Titrant 1 Volume Alert:	Off																													
Titrant 1 Age Reminder:	0 days																													
Titrant 2 Volume Alert:	Off																													
Titrant 2 Age Reminder:	0 days																													
Tray Type:	Auto Detect																													
Beaker Detection:																														
USB Link with PC	18 beakers																													
Setup Balance	16 beakers																													
Restore Autosampler Setting	12 beakers																													
	Auto Detect																													
Select	Escape																													

### 11.3.7. BEAKER DETECTION

Option: Enabled or Disabled

The autosampler detects the presence of a beaker when it is under the dispenser. This prevents titrations from occurring when no beaker is present.

**WARNING:** If this feature is disabled, the autosampler will titrate in any spot on the tray a sample has been entered. Please ensure all beakers are correctly positioned before starting the sequence. Otherwise, serious injury could result.

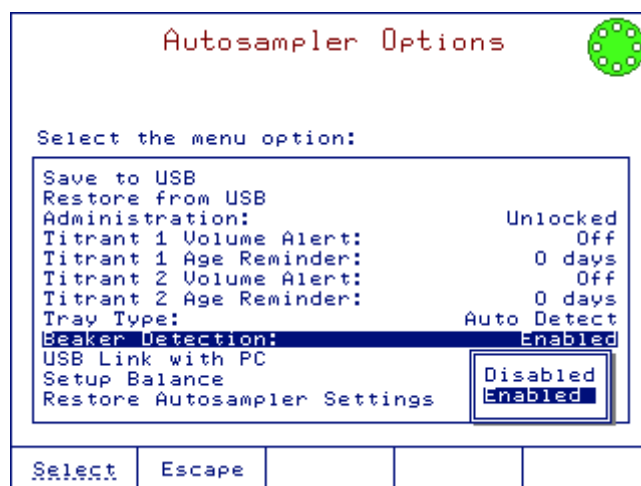

### 11.3.8. USB LINK WITH PC

In order to use this feature, the USB cable needs to connect titrator to the PC.

Make sure that the **HI900** PC application is running on the PC. See **3.12. USB LINK WITH PC** section for more information.

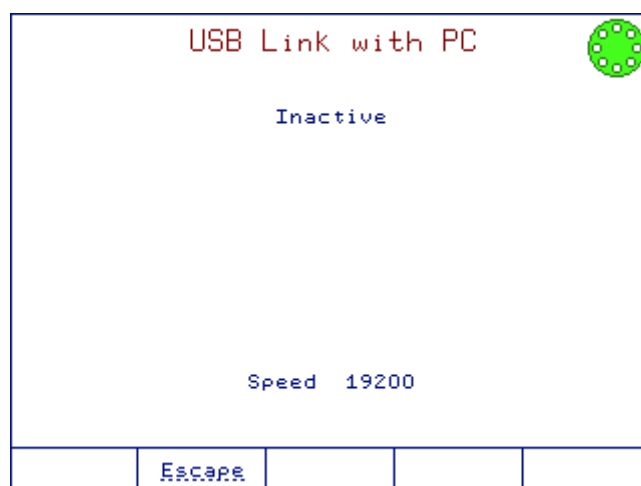

### 11.3.9. SETTING UP THE ANALYTICAL BALANCE

This screen allows the users to connect an analytical balance for automatic acquisition of sample mass prior to titration or standardization. See [3.13. SETUP BALANCE INTERFACE](#) section for more information.

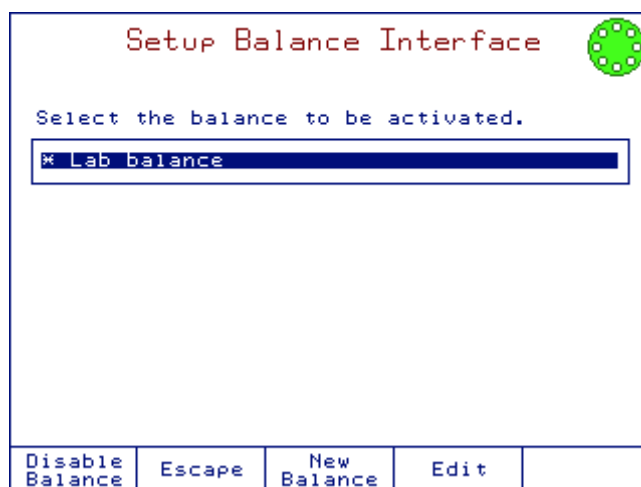

### 11.3.10. RESTORE AUTOSAMPLER SETTINGS

This option restores the manufacturer settings for the autosampler interface only!

*Note: This will delete all user-created sequences, tray reports, etc.*



### 11.4. AUTOSAMPLER SEQUENCES

All of the parameters required to complete an analysis on the autosampler are grouped into a sequence.

A default sequence is provided; this sequence is used as a starting point for creating user-defined sequences. Up to 30 sequences can be created and stored on the titrator.

User-defined sequences allow the user to customize reagent additions and rinsing cycles to suit specific applications.

New sequences are created in the select sequence screen.

### 11.4.1. SELECTING A SEQUENCE

To select a sequence, press  from the main screen. A list of available sequences will be displayed. In the **Autosampler Sequence** screen, you can view the list of all available sequences.

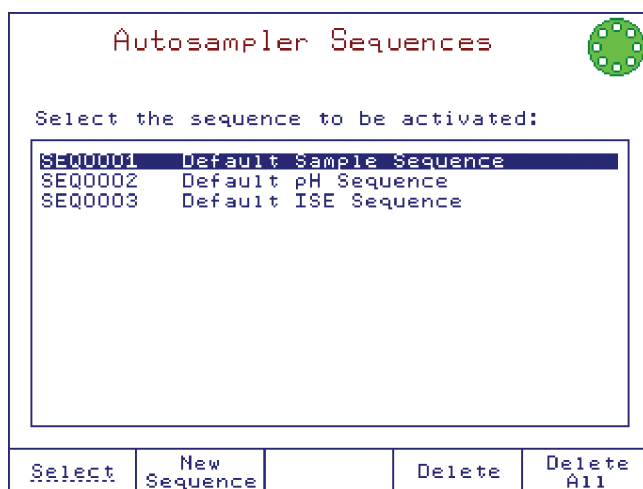



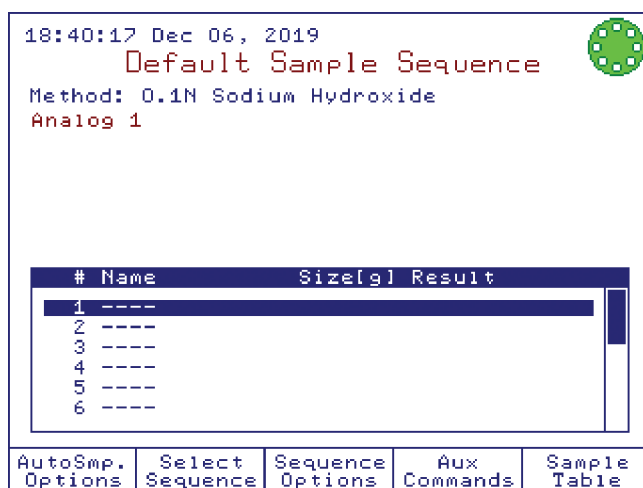

To select a sequence, highlight the sequence and press . The name of the selected sequence will be displayed on the main screen.



### 11.4.2. CREATING A SEQUENCE

Sequences are developed by the users in accordance with the analysis requirements. All sequence parameters can be modified by the user.

To create a new sequence, start from the default sequence or a previously created sequence and follow these steps:

1. Press  from the main screen.
2. Using the  and  keys, highlight an existing sequence from the list.
3. Press . A new sequence will be generated.
4. Press  to activate the new sequence.

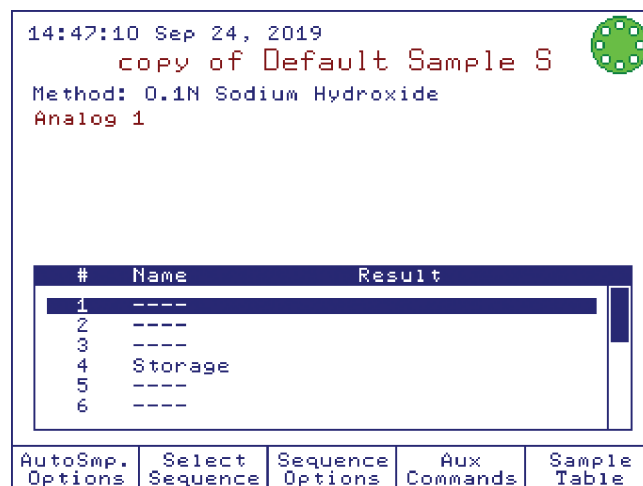
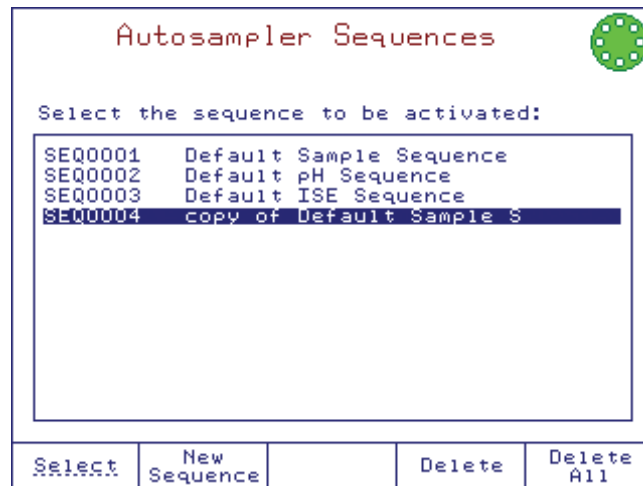



### 11.4.3. DELETING A SEQUENCE

To remove a sequence press **Select Sequence** from the main screen then highlight the sequence you want to delete and press **Delete**. A screen will appear in order to confirm the deletion. Press **Delete** again to confirm or press escape to cancel the operation.

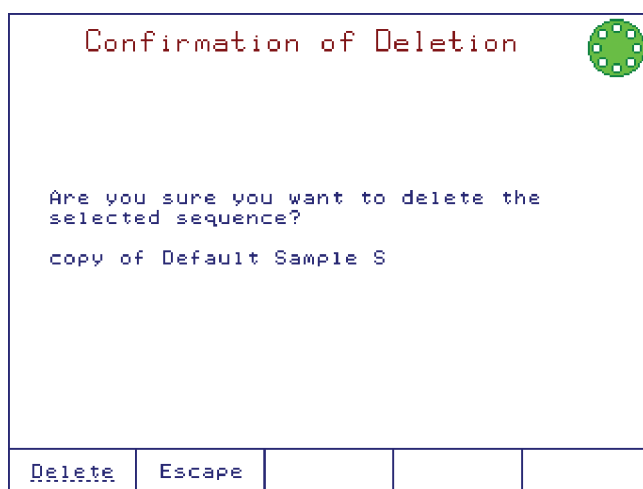

### 11.4.4. SEQUENCE TYPES

The autosampler can run three sequence types:

Sample Analysis

pH Calibration

ISE Calibration

## 11.5. SAMPLE ANALYSIS SEQUENCE

### 11.5.1. VIEW / MODIFY SEQUENCE

To modify the sequence options, press **Sequence Options** from the main screen. A list of all the parameters for the selected sequence will be displayed. Using the **▲** and **▼** keys, highlight the option you want to modify and press **Select**.

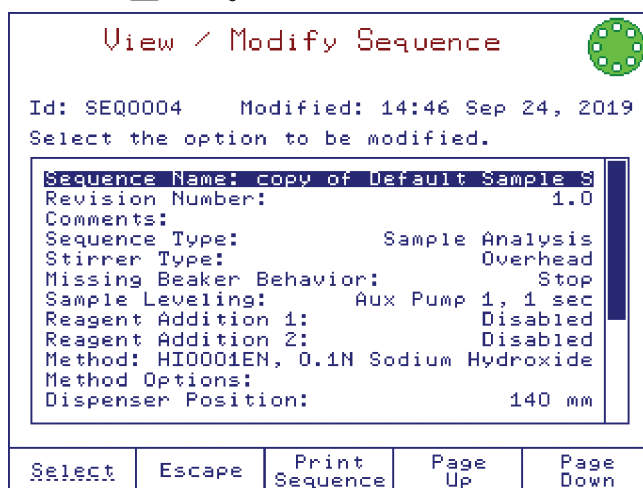

To exit the **View / Modify Sequence** screen, press **Escape**.

You can choose to save the modifications or to discard them.

Saving Sequence

Select a menu option.

Save Sequence  
 Exit Without Saving Sequence

"Escape" - exit without saving sequence.

Select	Escape			
--------	--------	--	--	--

#### 11.5.1.1. Sequence Name

Option: Up to 24 characters

Sequence Name

Select the highlighted letter by using the arrow keys then press "Enter". Select the empty field for a space. Press Accept to save the entered text.

█	A	B	C	D	E	F	G	H	I	J	K	L
M	N	O	P	Q	R	S	T	U	V	W	X	Y
Z	a	b	c	d	e	f	g	h	i	j	k	l
m	n	o	p	q	r	s	t	u	v	w	x	y
z	À	Á	Â	Ã	Ä	Å	Ç	È	É	Ê	Ë	Ì
Í	Î	Ï	Ñ	Ò	Ó	Ô	Õ	Ö	ß	à	á	â
ã	ä	å	è	é	ê	ë	ì	í	î	ï	ò	ó
ô	õ	ö	ù	ú	û	ü	ÿ					
				¡	¢	£	¤	¥	¦	§	¨	©
ª	«	¬	­	®	¯	°	±	²	³	´	µ	¶
·	¸	¹	º	»	¼	½	¾	¿				
					¡	¢	£	¤	¥	¦	§	¨
©	ª	«	¬	­	®	¯	°	±	²	³	´	µ
¶	·	¸	¹	º	»	¼	½	¾	¿			
						¡	¢	£	¤	¥	¦	§
¨	©	ª	«	¬	­	®	¯	°	±	²	³	´
µ	¶	·	¸	¹	º	»	¼	½	¾	¿		
							¡	¢	£	¤	¥	¦
§	¨	©	ª	«	¬	­	®	¯	°	±	²	³
´	µ	¶	·	¸	¹	º	»	¼	½	¾	¿	
								¡	¢	£	¤	¥
¦	§	¨	©	ª	«	¬	­	®	¯	°	±	²
³	´	µ	¶	·	¸	¹	º	»	¼	½	¾	¿
									¡	¢	£	¤
¥	¦	§	¨	©	ª	«	¬	­	®	¯	°	±
²	³	´	µ	¶	·	¸	¹	º	»	¼	½	¾
¿										¡	¢	£
¤	¥	¦	§	¨	©	ª	«	¬	­	®	¯	°
±	²	³	´	µ	¶	·	¸	¹	º	»	¼	½
¾	¿										¡	¢
£	¤	¥	¦	§	¨	©	ª	«	¬	­	®	¯
°	±	²	³	´	µ	¶	·	¸	¹	º	»	¼
½	¾	¿										¡
¢	£	¤	¥	¦	§	¨	©	ª	«	¬	­	®
¯	°	±	²	³	´	µ	¶	·	¸	¹	º	»
¼	½	¾	¿									
	¡	¢	£	¤	¥	¦	§	¨	©	ª	«	¬
­	®	¯	°	±	²	³	´	µ	¶	·	¸	¹
º	»	¼	½	¾	¿							
		¡	¢	£	¤	¥	¦	§	¨	©	ª	«
¬	­	®	¯	°	±	²	³	´	µ	¶	·	¸
¸	¹	º	»	¼	½	¾	¿					
				¡	¢	£	¤	¥	¦	§	¨	©
ª	«	¬	­	®	¯	°	±	²	³	´	µ	¶
·	¸	¹	º	»	¼	½	¾	¿				
					¡	¢	£	¤	¥	¦	§	¨
©	ª	«	¬	­	®	¯	°	±	²	³	´	µ
¶	·	¸	¹	º	»	¼	½	¾	¿			
						¡	¢	£	¤	¥	¦	§
¨	©	ª	«	¬	­	®	¯	°	±	²	³	´
µ	¶	·	¸	¹	º	»	¼	½	¾	¿		
							¡	¢	£	¤	¥	¦
§	¨	©	ª	«	¬	­	®	¯	°	±	²	³
´	µ	¶	·	¸	¹	º	»	¼	½	¾	¿	
								¡	¢	£	¤	¥
¦	§	¨	©	ª	«	¬	­	®	¯	°	±	²
³	´	µ	¶	·	¸	¹	º	»	¼	½	¾	¿
									¡	¢	£	¤
¥	¦	§	¨	©	ª	«	¬	­	®	¯	°	±
²	³	´	µ	¶	·	¸	¹	º	»	¼	½	¾
¿										¡	¢	£
¤	¥	¦	§	¨	©	ª	«	¬	­	®	¯	°
±	²	³	´	µ	¶	·	¸	¹	º	»	¼	½
¾	¿										¡	¢
£	¤	¥	¦	§	¨	©	ª	«	¬	­	®	¯
°	±	²	³	´	µ	¶	·	¸	¹	º	»	¼
½	¾	¿										¡
	¡	¢	£	¤	¥	¦	§	¨	©	ª	«	¬
­	®	¯	°	±	²	³	´	µ	¶	·	¸	¹
º	»	¼	½	¾	¿							
		¡	¢	£	¤	¥	¦	§	¨	©	ª	«
¬	­	®	¯	°	±	²	³	´	µ	¶	·	¸
¸	¹	º	»	¼	½	¾	¿					
				¡	¢	£	¤	¥	¦	§	¨	©
ª	«	¬	­	®	¯	°	±	²	³	´	µ	¶
·	¸	¹	º	»	¼	½	¾	¿				
					¡	¢	£	¤	¥	¦	§	¨
©	ª	«	¬	­	®	¯	°	±	²	³	´	µ
¶	·	¸	¹	º	»	¼	½	¾	¿			
						¡	¢	£	¤	¥	¦	§
¨	©	ª	«	¬	­	®	¯	°	±	²	³	´
µ	¶	·	¸	¹	º	»	¼	½	¾	¿		
							¡	¢	£	¤	¥	¦
§	¨	©	ª	«	¬	­	®	¯	°	±	²	³
´	µ	¶	·	¸	¹	º	»	¼	½	¾	¿	
								¡	¢	£	¤	¥
¦	§	¨	©	ª	«	¬	­	®	¯	°	±	²
³	´	µ	¶	·	¸	¹	º	»	¼	½	¾	¿
									¡	¢	£	¤
¥	¦	§	¨	©	ª	«	¬	­	®	¯	°	±
²	³	´	µ	¶	·	¸	¹	º	»	¼	½	¾
¿										¡	¢	£
¤	¥	¦	§	¨	©	ª	«	¬	­	®	¯	°
±	²	³	´	µ	¶	·	¸	¹	º	»	¼	½
¾	¿										¡	¢
£	¤	¥	¦	§	¨	©	ª	«	¬	­	®	¯
°	±	²	³	´	µ	¶	·	¸	¹	º	»	¼
½	¾	¿										¡
	¡	¢	£	¤	¥	¦	§	¨	©	ª	«	¬
­	®	¯	°	±	²	³	´	µ	¶	·	¸	¹
º	»	¼	½	¾	¿							
		¡	¢	£	¤	¥	¦	§	¨	©	ª	«
¬	­	®	¯	°	±	²	³	´	µ	¶	·	¸
¸	¹	º	»	¼	½	¾	¿					
				¡	¢	£	¤	¥	¦	§	¨	©
ª	«	¬	­	®	¯	°	±	²	³	´	µ	¶
·	¸	¹	º	»	¼	½	¾	¿				
					¡	¢	£	¤	¥	¦	§	¨
©	ª	«	¬	­	®	¯	°	±	²	³	´	µ
¶	·	¸	¹	º	»	¼	½	¾	¿			
						¡	¢	£	¤	¥	¦	§
¨	©	ª	«	¬	­	®	¯	°	±	²	³	´
µ	¶	·	¸	¹	º	»	¼	½	¾	¿		
							¡	¢	£	¤	¥	¦
§	¨	©	ª	«	¬	­	®	¯	°	±	²	³
´	µ	¶	·	¸	¹	º	»	¼	½	¾	¿	
								¡	¢	£	¤	¥
¦	§	¨	©	ª	«	¬	­	®	¯	°	±	²
³	´	µ	¶	·	¸	¹	º	»	¼	½	¾	¿
									¡	¢	£	¤
¥	¦	§	¨	©	ª	«	¬	­	®	¯	°	±
²	³	´	µ	¶	·	¸	¹	º	»	¼	½	¾
¿										¡	¢	£
¤	¥	¦	§	¨	©</							



### 11.5.1.6. Missing Beaker Behavior

#### Option: Pause, Skip, Stop

Select type of behaviour when beaker detection is enabled and no beaker is detected.

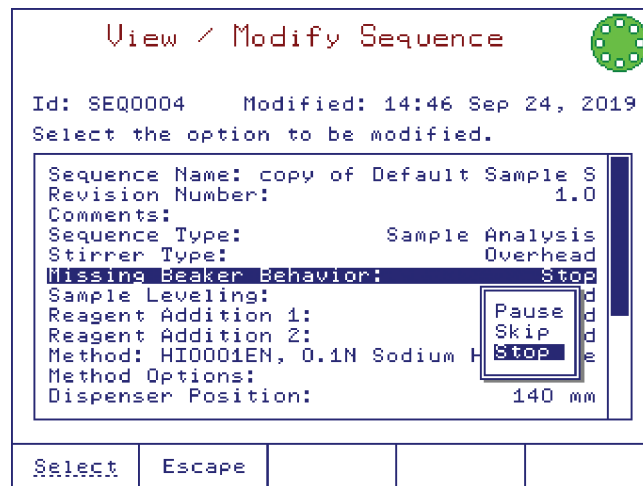

**Pause** The autosampler will pause the sequence at the current beaker and wait for the user before continuing the analysis.

**Skip** The autosampler will automatically move to the next available sample.

**Stop** All operations will stop and the analysis will be stopped.

### 11.5.1.7. Sample Leveling

#### Option: Disabled or Enabled

Volumetric samples that do not require high accuracy can be leveled to the correct volume rather than manually dispensed with a pipette. During sample leveling, excess sample is added to each beaker and then excess is being removed by the autosampler through the aspiration tube. This allows samples to be quickly poured into each beaker by the user while the autosampler accurately removes excess.

**Note:** Sample leveling requires one peristaltic pump configured for aspiration using HI920-203 Tubing Set for aspiration.

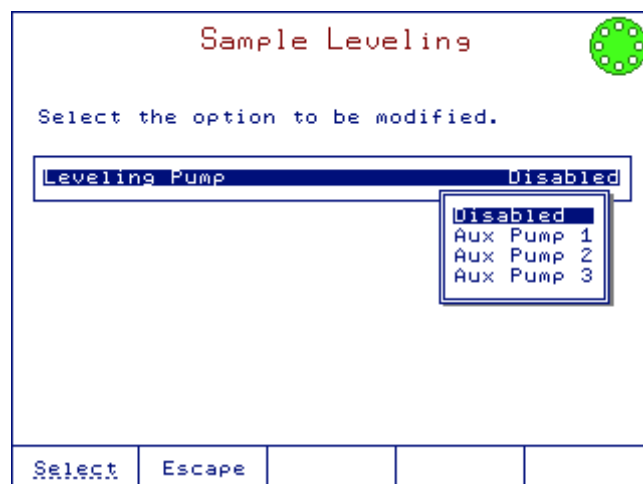

### 11.5.1.7.1. Leveling Pump

Select the peristaltic pump that is connected to the aspiration tube.

Sample Leveling	
Select the option to be modified.	
Leveling Pump	Aux Pump 1
Leveling Time	10 sec
Head Height	120 mm
Select	Escape

### 11.5.1.7.2. Leveling Time

Option: 1 second to 300 seconds

Set the duration that the peristaltic pump will run for.

Leveling Time	
Enter the period of time for running auxiliary pump.	
10 sec	
Low limit: 1 second	
High limit: 300 seconds	
Accept	Escape
Delete Digit	

### 11.5.1.7.3. Dispenser Head Height

#### Option: 10 to 150 mm

The height for the dispenser head should be set to produce the sample volume that is defined within method options. The correct height must be determined experimentally by the user and will depend on the sample size, beaker shape and size, and the aspiration tube position.

The easiest way to determine the volume of a particular height setting is to manually aspirate water from a pre-weighed beaker and weigh the remaining water in the beaker.

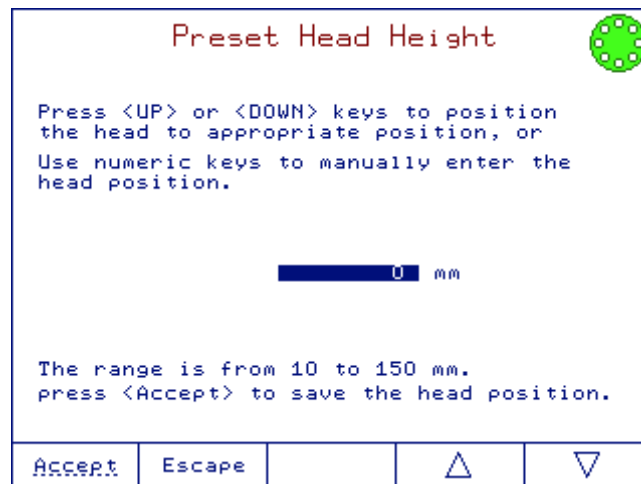

### 11.5.1.8. Reagent Addition 1 and 2

#### Option: Disabled or Enabled

Reagents and / or deionized water can be automatically added to each sample using the reagent addition feature.

**Note:** Reagent addition requires separate peristaltic pumps for each reagent. The pumps should be configured for dispensing, using HI920-208 Tubing set for dispensing. The HI922 can perform up to two reagent additions.

#### 11.5.1.8.1. Reagent Pump

Select the peristaltic pump that is connected to the reagent container.

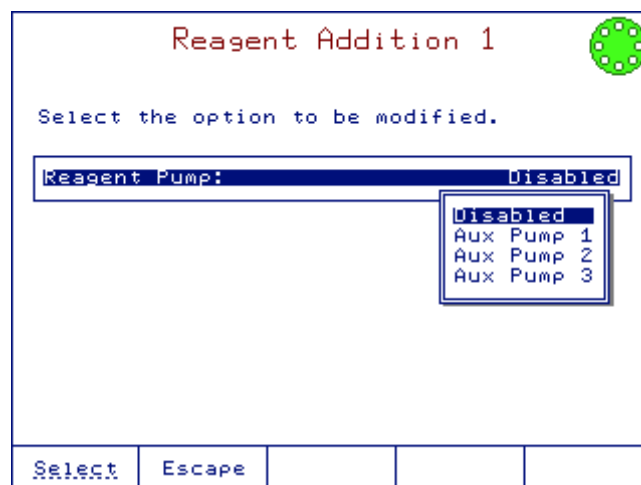

Reagent Addition 1	
Select the option to be modified.	
Reagent Pump:	Aux Pump 1
Dispenser Position:	130 mm
Dispensing Time:	1 sec
Stirring Time:	0 sec
Dispenser Waiting Position:	Down
Wait Time:	0 sec
Select	Escape

### 11.5.1.8.2. Dispenser Position

#### Option: 10 to 150 mm

Enter the position of the dispenser during reagent addition and stir time.

Preset Head Height	
Press <UP> or <DOWN> keys to position the head to appropriate position, or Use numeric keys to manually enter the head position.	
130 mm	
The range is from 10 to 150 mm. press <Accept> to save the head position.	
Accept	Escape
Delete Digit	Go to Position

### 11.5.1.8.3. Dispensing Time

#### Option: 1 to 300 seconds

Enter the dispensing time required to add the desired amount of reagent.

**Note:** This time should be determined experimentally. The flow rate is approximately 200 mL per min.

Dispensing Time	
Enter the period of time for running auxiliary pump.	
5 sec	
Low limit: 1 second High limit: 300 seconds	
Accept	Escape
Delete Digit	

## 11.5.1.8.4. Stirring Time

Option: 0 to 1800 seconds

Stirring Time 				
Please enter the stirring time in seconds.				
<div style="background-color: black; color: white; display: inline-block; padding: 2px 10px;">2</div> sec				
Low limit: 0 second High limit: 1800 seconds				
Accept	Escape	Delete Digit		

## 11.5.1.8.5. Dispenser Waiting Position

Option: Up or Down

The user can set the position of the dispenser during wait time. This is useful if it is undesirable for the electrode(s) to be immersed in the solution for extended periods of time.

Reagent Addition 1 																
Select the option to be modified.																
<table border="1" style="width: 100%;"> <tbody> <tr> <td>Reagent Pump:</td> <td>Aux Pump 1</td> </tr> <tr> <td>Dispenser Position:</td> <td>130 mm</td> </tr> <tr> <td>Dispensing Time:</td> <td>1 sec</td> </tr> <tr> <td>Stirring Time:</td> <td>0 sec</td> </tr> <tr> <td><b>Dispenser Waiting Position:</b></td> <td><b>Down</b></td> </tr> <tr> <td>Wait Time:</td> <td>c</td> </tr> </tbody> </table>					Reagent Pump:	Aux Pump 1	Dispenser Position:	130 mm	Dispensing Time:	1 sec	Stirring Time:	0 sec	<b>Dispenser Waiting Position:</b>	<b>Down</b>	Wait Time:	c
Reagent Pump:	Aux Pump 1															
Dispenser Position:	130 mm															
Dispensing Time:	1 sec															
Stirring Time:	0 sec															
<b>Dispenser Waiting Position:</b>	<b>Down</b>															
Wait Time:	c															
<div style="border: 1px solid black; padding: 2px; display: inline-block;">           Up Down         </div>																
Select	Escape															



### 11.5.1.8.6. Wait Time

#### Option: 0 to 1800 seconds

Set the reaction time. This is the amount of time, after the stirring is completed, that the autosampler will wait before performing any other actions.

Wait Time				
Please enter the wait time in seconds.				
<div style="background-color: black; color: white; display: inline-block; padding: 2px 10px;">2</div> sec				
Low limit: 0 second				
High limit: 1800 seconds				
Accept	Escape	Delete Digit		

### 11.5.1.8.7. Addition Phase (linked methods only)

#### Option: First Titration or Second Titration

Set the addition phase for the reagent addition. Reagent addition can be done before the first titration or before the second titration.

Reagent Addition 1	
Select the option to be modified.	
Reagent Pump:	Aux Pump 1
Dispenser Position:	130 mm
Dispensing Time:	C
Stirring Time:	First Titration
Dispenser Waiting Pos:	Second Titration
Wait Time:	C
Addition Phase:	First Titration
Select	Escape

### 11.5.1.9. Analysis Method

The following types of methods can be run on the autosampler:

#### Non-linked methods

- Sample titration, single endpoint (fixed or equivalence point)
- Sample titration, multiple equivalence point
- Direct reading
- Titrant standardization
- Back titration

#### Linked methods

Sample titration, single endpoint (fixed or equivalence point), Linked to:

- Sample titration, single endpoint (fixed or equivalence point)
- Sample titration, multiple equivalence point
- Direct reading

Sample titration, multiple equivalence point, Linked to:

- Sample titration, single endpoint (fixed or equivalence point)
- Sample titration, multiple equivalence point
- Direct reading

Direct reading, Linked to

- Sample titration, single endpoint (fixed or equivalence point)
- Sample titration, multiple equivalence point
- Direct reading
- Back titration

Back titration, Linked to:

- Direct reading

Analysis Methods				
Select the method to be activated.				
<div style="border: 1px solid black; padding: 5px;">           HI0001EN 0.1N Sodium Hydroxide            HI0002EN 0.1N Hydrochloric Acid            HI0003EN 0.1M Sodium Thiosulfate            HI0010EN 0.1M FAS            HI0200EN 0.02M Silver Nitrate            HI1004EN Alkalinity of Water            HI1005EN Acidity of Water            HI1007EN Chloride in Water            HI1008EN Neutralization w/ H2SO4            HI1009EN Neutralization w/ NaOH            HI1011EN Troubleshooting 1            HI1012EN Troubleshooting 2            HI1014EN Concentration of H3PO4  <b>USER0001 Free Acidity</b> </div>				
Select	New Method	Delete	Page Up	Page Down

### 11.5.1.10. Method Options

The analysis method options can be accessed directly from the autosampler interface. Analysis method options can be reviewed and / or modified if necessary. See [4.5. METHOD OPTIONS](#) section for more information.

View/Modify Method																																
Id: USER0001      Modified: 15:36 Sep 27, 2019																																
Select the option to be modified.																																
<table border="1"> <tr> <td>Name:</td> <td>Free Acidity</td> </tr> <tr> <td>Method Revision:</td> <td>1.0</td> </tr> <tr> <td>Analysis Type:</td> <td>Standard Titration</td> </tr> <tr> <td>Titrant pump:</td> <td>Pump 1</td> </tr> <tr> <td>Reagent Addition 1:</td> <td>Disabled</td> </tr> <tr> <td>Reagent Addition 2:</td> <td>Disabled</td> </tr> <tr> <td>Dosing Type:</td> <td>Dynamic</td> </tr> <tr> <td>End Point Mode:</td> <td>Fixed 8.300 pH</td> </tr> <tr> <td>Pre-Titration Volume:</td> <td>0.000 mL</td> </tr> <tr> <td>Pre-Titration Stir Time:</td> <td>0 sec</td> </tr> <tr> <td>Stirring Speed:</td> <td>1400 RPM</td> </tr> <tr> <td>Measurement Mode:</td> <td>Signal Stability</td> </tr> <tr> <td>Electrode Type:</td> <td>pH</td> </tr> <tr> <td>Blank Option:</td> <td>No Blank</td> </tr> </table>					Name:	Free Acidity	Method Revision:	1.0	Analysis Type:	Standard Titration	Titrant pump:	Pump 1	Reagent Addition 1:	Disabled	Reagent Addition 2:	Disabled	Dosing Type:	Dynamic	End Point Mode:	Fixed 8.300 pH	Pre-Titration Volume:	0.000 mL	Pre-Titration Stir Time:	0 sec	Stirring Speed:	1400 RPM	Measurement Mode:	Signal Stability	Electrode Type:	pH	Blank Option:	No Blank
Name:	Free Acidity																															
Method Revision:	1.0																															
Analysis Type:	Standard Titration																															
Titrant pump:	Pump 1																															
Reagent Addition 1:	Disabled																															
Reagent Addition 2:	Disabled																															
Dosing Type:	Dynamic																															
End Point Mode:	Fixed 8.300 pH																															
Pre-Titration Volume:	0.000 mL																															
Pre-Titration Stir Time:	0 sec																															
Stirring Speed:	1400 RPM																															
Measurement Mode:	Signal Stability																															
Electrode Type:	pH																															
Blank Option:	No Blank																															
Select	Escape	Print Method	Page Up	Page Down																												

### 11.5.1.11. Dispenser Position

#### Option: 10 to 150 mm

User can select the height for the dispenser head to be positioned at during titration (140 mm - by default).

Preset Head Height 				
Press <UP> or <DOWN> keys to position the head to appropriate position, or Use numeric keys to manually enter the head position.				
<div style="border: 1px solid black; display: inline-block; padding: 2px 10px;">140 mm</div>				
The range is from 10 to 150 mm. press <Accept> to save the head position.				
Accept	Escape	Delete Digit		Go to Position

## 11.5.1.12. Head Up Wait Time

**Option: 1 to 30 seconds**

Set the duration that the autosampler will wait with the dispenser in the up position for any drops of solution to fall off of the electrodes or stirrer before moving to another sample or rinse beaker.

Head Up Wait Time 

Please enter the wait time in seconds.

2 sec

Low limit: 1 second  
High limit: 30 seconds

Accept	Escape	Delete Digit	
--------	--------	--------------	--

## 11.5.1.13. Sample Aspiration

**Option: Disabled, Aspirate Only, Aspirate / Spray Rinse**

Reacted samples may be aspirated into a waste container after each titration.

**Note:** Sample aspiration requires one peristaltic pump to be configured for aspiration, using HI920-203 Tubing Set for Aspiration.

Aspirate Sample 

Select the option to be modified.

Aspiration Option: Disabled

- Disabled
- Aspirate Only
- Aspirate/Spray Rinse

Select	Escape		
--------	--------	--	--

**Aspiration Only** The existing waste from the sample beaker will be removed according to the parameters defined in this menu.

**Aspirate / Spray** Reserved for future

### 11.5.1.13.1. Aspiration Pump

Option: Disabled, Auxiliary Pump 1, Auxiliary Pump 2, Auxiliary Pump 3

Select the peristaltic pump that is connected to the aspiration tube.

Aspirate Sample					
Select the option to be modified.					
Aspiration Option:	Aspirate Only				
Aspiration Pump:	Disabled				
Aspiration Time:					
Head Height:					
	<table border="1"> <tr><td>Disabled</td></tr> <tr><td>Aux Pump 1</td></tr> <tr><td>Aux Pump 2</td></tr> <tr><td>Aux Pump 3</td></tr> </table>	Disabled	Aux Pump 1	Aux Pump 2	Aux Pump 3
Disabled					
Aux Pump 1					
Aux Pump 2					
Aux Pump 3					
Select	Escape				

### 11.5.1.13.2. Aspiration Time

Option: 1 to 300 seconds

Set the duration that the peristaltic pump will run.

Aspiration Time	
Enter the period of time for running auxiliary pump.	
<div style="background-color: black; color: white; display: inline-block; padding: 2px 10px;">15</div> sec	
Low limit:	1 second
High limit:	300 seconds
Accept	Escape
Delete Digit	

### 11.5.1.13.3. Dispenser Head Height

**Option: 10 to 150 mm**

Set the height for the dispenser head. The aspiration tube should be positioned such that it reaches the bottom of the sample beaker when the dispenser head is positioned in the range of 10 to 150 mm.

Preset Head Height 				
Press <UP> or <DOWN> keys to position the head to appropriate position, or Use numeric keys to manually enter the head position.				
140 mm				
The range is from 10 to 150 mm. press <Accept> to save the head position.				
Accept	Escape	Delete Digit		Go to Position

### 11.5.1.14. Rinse

**Option: Disabled, Dip Rinse, Spray Rinse**

The autosampler can perform a dip rinse function after each analysis. Up to three dip rinses can be performed in a dedicated rinse beaker dip-rinse function.

Rinse 1 				
Select the option to be modified.				
Rinse Option: Disabled				
Select	Escape			

**Dip Rinse** Dip rinse option can be used after each analysis to clean the electrodes and stirrer of contaminants, using dedicated rinsing beakers.

**Spray Rinse** Reserved for future

## 11.5.1.14.1. Rinse Beaker

Select the tray position for the dedicated rinse beaker.

Rinse 1				
Select the option to be modified.				
Rinse Option:	Dip Rinse			
Rinse Beaker:	Beaker 1			
Rinse Time:				
Dispenser Position:	Beaker 1			
Head Up Wait Time:				
Stirrer:				
Select	Escape			

## 11.5.1.14.2. Rinse Time

Option: 1 to 300 seconds

Rinse Time				
Enter the period of time you would like to remain in the rinse beaker.				
10 sec				
Low limit: 1 second				
High limit: 300 seconds				
Accept	Escape	Delete Digit		

## 11.5.1.14.3. Dispenser Position

Option: 10 to 150 mm

Set the height for the dispenser head during rinsing.

Preset Head Height				
Press <UP> or <DOWN> keys to position the head to appropriate position, or Use numeric keys to manually enter the head position.				
140 mm				
The range is from 10 to 150 mm. press <Accept> to save the head position.				
Accept	Escape	Delete Digit		Go to Position

## 11.5.1.14.4. Head Up Wait Time

**Option: 1 to 300 seconds**

Set the duration that the autosampler will wait with the dispenser in the up position for any drops of solution to fall off of the electrodes or stirrer before moving to another sample or rinse beaker.

Head Up Wait Time 				
Please enter the stirring time in seconds.				
<div style="border: 1px solid black; display: inline-block; padding: 2px;">1</div> sec				
Low limit: 1 second High limit: 300 seconds				
Accept	Escape	Delete Digit		

## 11.5.1.14.5. Stirrer

**Option: Enabled or Disabled**

Select if the stirrer will run during rinsing.

Rinse 1 																
Select the option to be modified.																
<table border="1" style="width: 100%;"> <tbody> <tr> <td>Rinse Option:</td> <td>Dip Rinse</td> </tr> <tr> <td>Rinse Beaker:</td> <td>Beaker 1</td> </tr> <tr> <td>Rinse Time:</td> <td>10 sec</td> </tr> <tr> <td>Dispenser Position:</td> <td>140 mm</td> </tr> <tr> <td>Head Up Wait Time:</td> <td>1 sec</td> </tr> <tr> <td><b>Stirrer:</b></td> <td><b>Enabled</b></td> </tr> </tbody> </table>					Rinse Option:	Dip Rinse	Rinse Beaker:	Beaker 1	Rinse Time:	10 sec	Dispenser Position:	140 mm	Head Up Wait Time:	1 sec	<b>Stirrer:</b>	<b>Enabled</b>
Rinse Option:	Dip Rinse															
Rinse Beaker:	Beaker 1															
Rinse Time:	10 sec															
Dispenser Position:	140 mm															
Head Up Wait Time:	1 sec															
<b>Stirrer:</b>	<b>Enabled</b>															
<table border="1" style="margin-left: auto;"> <tbody> <tr> <td>Disabled</td> </tr> <tr> <td><b>Enabled</b></td> </tr> </tbody> </table>					Disabled	<b>Enabled</b>										
Disabled																
<b>Enabled</b>																
Select	Escape															



## 11.5.1.15. Beaker Height

Option: 30 to 120 mm

Set the height of the beaker being used on the autosampler.

**Beaker Height**

Enter the beaker height in mm.

100 mm

Low limit: 30 mm  
High limit: 120 mm

Accept	Escape	Delete Digit	
--------	--------	--------------	--

## 11.5.1.16. Position when Finished

Option: Home, Sample, Storage

**View / Modify Sequence**

Id: SEQ0002    Modified: 11:48 Jul 24, 2018  
Select the option to be modified.

Reagent Addition 2:	Disabled
Method:	USER0003, Free Acidity
Linked To:	USER0004, Direct pH reading
Method Options:	
Dispenser Position:	140 mm
Head Up Wait Time:	1 sec
Aspirate Sample:	As: y
Rinse 1:	Home d
Rinse 2:	Sample d
Rinse 3:	Storage d
Beaker Height:	m
Position when finished:	Storage

Select	Escape		
--------	--------	--	--

- Home**            The dispenser head will be in the up positioned above beaker one.
- Sample**        The dispenser head will remain down in the last sample that was analyzed / titrated.
- Storage**        The dispenser head will be down in a preset beaker containing storage solution.

### 11.5.1.17. Storage Beaker (Position when finished, storage only)

User can select the beaker to be placed in storage at the end of a sequence analysis. After the sequence has been completed, the autosampler will automatically move the beaker to storage and lower the dispenser head.

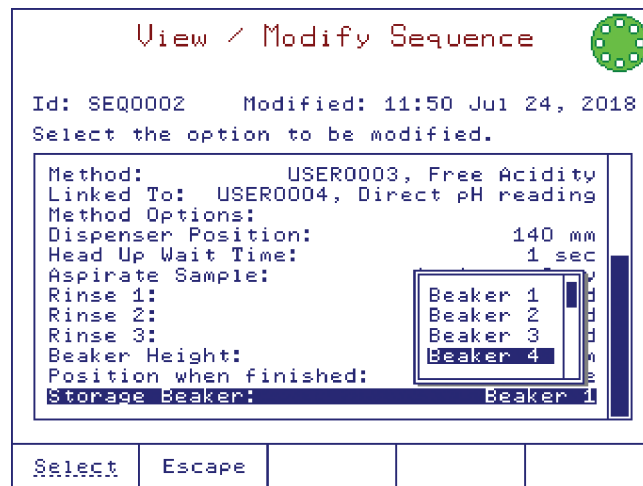

### 11.5.2. SAMPLE TABLE

All sample information is entered into the sample table according to the tray position. The sample table screen is the default screen when entering the autosampler interface while the autosampler is idle. The sample table is automatically formatted with the appropriate beaker number, with rinse / storage beaker positions reserved.

To add a sample to the sample table follow the steps detailed below.

Use the  $\Delta$  and  $\nabla$  keys to highlight an empty beaker position.

 Opens the sample dialog box. The user can then edit the sample name and size.

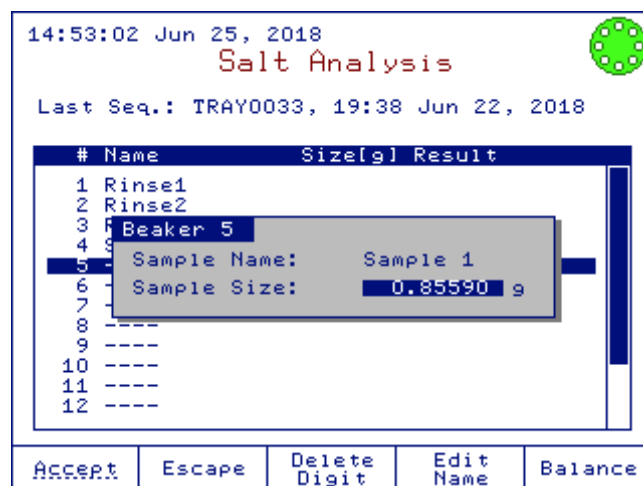

 Enter the current sample name and size into the sample table.

 Return to the sample table.

 Modify the sample size.

 Modify the sample name.

 Access the balance interface for direct entry of sample weight (if available).

Several features have been added to speed up sample entry, depending on your peripheral connections and analysis method. With an empty table position highlighted, below detailed features are available.

<b>Name entry</b>	If a non-numeric character is entered using an external keyboard, the sample name will be updated.
<b>Size entry</b>	If a numeric character is entered on the keypad or external keyboard, the sample size will be updated. The sample name will be auto-incremented.
<b>Barcode reader</b>	Scanning a barcode automatically enters the barcode into the sample name field.
<b>Fixed sample size</b>	The sample dialog box is omitted if the sample size entry is set to Fixed. Any character entered from the keypad or external keyboard will go directly to the Edit Name screen.
<b>Autofill (Fixed sample size)</b>	All empty sample table positions are filled automatically. The sample name will be auto-incremented.

### 11.5.3. RUNNING SAMPLE ANALYSIS SEQUENCE

The sequence can be started by pressing the  key.

The autosampler will process each sample according to the settings in sequence options.

While the autosampler is running, the top part of the screen shows titration information for the current titration, and the bottom part of the screen shows a portion of the sample table.

The sample in progress is marked with  symbol in the sample table.

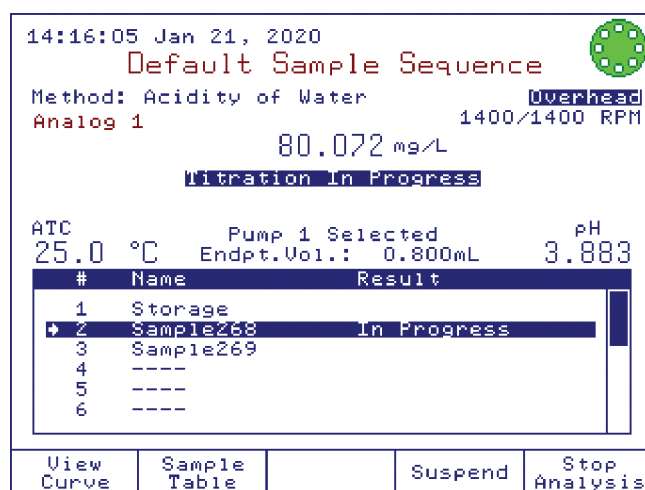

#	Name	Result
1	Storage	
+	Sample268	In Progress
3	Sample269	
4	----	
5	----	
6	----	

If the selected titration method is linked, the linked method will be displayed below the sample when it is in progress.

14:25:56 Jan 21, 2020 





**Default Sample Sequence**

Method: Acidity of Water  
 LinkedTo: pH Direct reading  
 Analog 1 7.074 pH  
 Analysis Completed

#	Name	Result
1	Storage	
2	Sample283	58.034
*	Sample283	7.074
3	Sample284	pH
4	Sample285	
5	Sample286	

Sample Table      Suspend

Use the  and  keys to scroll the sample table.

-  View the graph of the current titration.
-  View or modify the sample table entries. Sample can be added to the sample table while the autosampler is running.
-  Pause the current titration.
-  End the current titration immediately and proceed to the next sample.

#### 11.5.4. RESULTS

Press  to view GLP Data or the  key for more information.

14:30:52 Jan 21, 2020 

**Default Sample Sequence**

Last Seq.: TRAY0013, 14:28 Jan 21, 2020

#	Name	Result
1	Storage	
2	Sample298	7.083
3	Sample299	3.877
4	----	pH
5	----	
6	----	
7	----	
8	----	
9	----	
10	----	
11	----	
12	----	

View Result    Auto Fill    Reset Table    AutoSmp. Setup

**Analysis Reports** 

Sequence Name: Default Sample Sequence  
 Tray ID: TRAY0013  
 Date & Time: 14:28 Jan 21, 2020

#	Sample Name	Result	Report Id
2	Sample298	7.083	pH_11301
3	Sample299	3.877	pH_11302

Escape    View Report    Print Report    Delete Report



## 11.6.1.2. Revision Number

Option: Up to 3 characters

Revision Number												
Select the highlighted letter by using the arrow keys then press "Enter". Select the empty field for a space. Press Accept to save the entered text.												
█	A	B	C	D	E	F	G	H	I	J	K	L
M	N	O	P	Q	R	S	T	U	V	W	X	Y
Z	a	b	c	d	e	f	g	h	i	j	k	l
m	n	o	p	q	r	s	t	u	v	w	x	y
z	À	Á	Â	Ã	Ä	Å	Ç	È	É	Ê	Ë	Ì
Î	Ñ	Ò	Ó	Ô	Õ	Ö	Ù	Ú	Û	Ü	Ý	Þ
à	á	â	ã	ä	å	ç	è	é	ê	ë	ì	í
î	ï	ñ	ò	ó	ô	õ	ö	ù	ú	û	ü	ý
þ	ÿ		!	"	#	\$	%	&	'	(	)	*
+	,	;	:	<	=	>	?					
1	2	3	4	5	6	7	8	9	0	.	.	.
1.0												
Accept	Escape	Delete Letter	Cursor Left	Cursor Right								

## 11.6.1.3. Comments

Option: Up to 20 characters

Comments												
Select the highlighted letter by using the arrow keys then press "Enter". Select the empty field for a space. Press Accept to save the entered text.												
█	A	B	C	D	E	F	G	H	I	J	K	L
M	N	O	P	Q	R	S	T	U	V	W	X	Y
Z	a	b	c	d	e	f	g	h	i	j	k	l
m	n	o	p	q	r	s	t	u	v	w	x	y
z	À	Á	Â	Ã	Ä	Å	Ç	È	É	Ê	Ë	Ì
Î	Ñ	Ò	Ó	Ô	Õ	Ö	Ù	Ú	Û	Ü	Ý	Þ
à	á	â	ã	ä	å	ç	è	é	ê	ë	ì	í
î	ï	ñ	ò	ó	ô	õ	ö	ù	ú	û	ü	ý
þ	ÿ		!	"	#	\$	%	&	'	(	)	*
+	,	;	:	<	=	>	?					
1	2	3	4	5	6	7	8	9	0	.	.	.
Accept	Escape	Delete Letter	Cursor Left	Cursor Right								

## 11.6.1.4. Sequence Type

Option: Sample Analysis, pH Calibration, ISE Calibration

View / Modify Sequence	
Id: SEQ0002      Modified: 18:41 Dec 06, 2019	
Select the option to be modified.	
Sequence Name:	Default pH Sequence
Revision Number:	1.0
Comments:	
Sequence Type:	pH Calibration
Analog Board:	1
Stirrer Type:	
Missing Beaker Behavior:	
pH Setup:	
Edit Sample Table:	
Dispenser Position:	140 mm
Head Up Wait Time:	1 sec
Aspirate Sample:	Disabled
Select	Escape

### 11.6.1.5. Analog Board

Option: Analog 1 or Analog 2 (if installed)

The screenshot shows the 'View / Modify Sequence' screen for sequence ID SEQ0002. The 'Analog Board' option is highlighted, and a dropdown menu is open showing 'Analog 1' and 'Analog 2' as options. Other settings include Sequence Name: Default pH Sequence, Revision Number: 1.0, Sequence Type: pH Calibration, Missing Beaker Behavior: p, pH Setup, Edit Sample Table, Dispenser Position: 140 mm, Head Up Wait Time: 1 sec, and Aspirate Sample: Disabled.

Select	Escape			
--------	--------	--	--	--

### 11.6.1.6. Stirrer Type

Option: Overhead or Magnetic

The screenshot shows the 'View / Modify Sequence' screen for sequence ID SEQ0002. The 'Stirrer Type' option is highlighted, and a dropdown menu is open showing 'Overhead' and 'Magnetic' as options. Other settings include Sequence Name: Default pH Sequence, Revision Number: 1.0, Sequence Type: pH Calibration, Analog Board: Analog 1, Missing Beaker Behavior: p, pH Setup, Edit Sample Table, Dispenser Position: m, Head Up Wait Time: 1 sec, and Aspirate Sample: Disabled.

Select	Escape			
--------	--------	--	--	--

### 11.6.1.7. Missing Beaker Behavior

Option: Pause, Stop

Select type of behaviour when beaker detection is enabled and no beaker is detected.

The screenshot shows the 'View / Modify Sequence' screen for sequence ID SEQ0002. The 'Missing Beaker Behavior' option is highlighted, and a dropdown menu is open showing 'Pause' and 'Stop' as options. Other settings include Sequence Name: Default pH Sequence, Revision Number: 1.0, Sequence Type: pH Calibration, Analog Board: Analog 1, Stirrer Type: Overhead, pH Setup, Edit Sample Table, Dispenser Position: m, Head Up Wait Time: c, and Aspirate Sample: Disabled.

Select	Escape			
--------	--------	--	--	--

- Pause** The autosampler will pause the sequence at the current beaker and wait for the user before continuing the analysis.
- Stop** All operations will stop and the analysis will be stopped.

## 11.6.1.8. pH Setup

This option allows the user to select pH Setup menu. See [6.2. pH SETUP](#) section for more information.

View / Modify Sequence

Id: SEQ0002      Modified: 18:41 Dec 06, 2019  
Select the option to be modified.

Sequence Name:	Default pH Sequence
Revision Number:	1.0
Comments:	
Sequence Type:	pH Calibration
Analog Board:	Analog 1
Stirrer Type:	Overhead
Missing Beaker Behavior:	Stop
<b>pH Setup:</b>	
Edit Sample Table:	
Dispenser Position:	140 mm
Head Up Wait Time:	1 sec
Aspirate Sample:	Disabled

Select	Escape	Print Sequence	Page Up	Page Down
--------	--------	----------------	---------	-----------

pH Setup

Select a menu option.

<b>Buffer Entry Type:</b>	Manual
First Cal Point:	Point
Edit Custom Buffers	
Edit Buffer Group	
Calibration Reminder:	Disabled
Set Reminder Period:	Disabled
Clear Calibration	
pH GLP Data	
Logging Interval:	Disabled
Stability Criteria:	Medium
pH Resolution:	X.XXX
Stirrer Configuration:	Always Stirring

Select	Escape			
--------	--------	--	--	--

## 11.6.1.9. Edit Sample Table

This option allows to add, remove and edit the calibration beakers in the tray.

Edit Sample Table

#	Name
1	Storage
2	Rinse01.679
3	pH01.679Hanna
4	Rinse04.010
5	pH04.010Hanna
6	Rinse10.010
7	pH10.010Hanna
8	Rinse07.010
9	pH07.010Hanna
10	----
11	----
12	----

Edit Buffer	Escape	Delete Buffer		
-------------	--------	---------------	--	--

**Note:** Up to five calibration beakers can be added. Highlighted beakers have already been added to the calibration sequence.



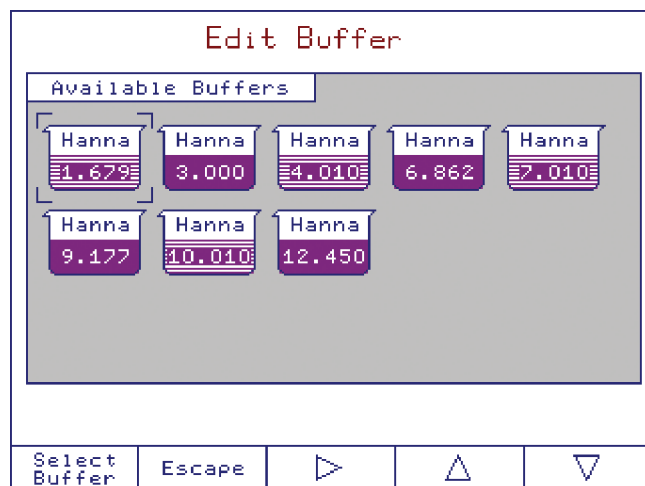

### 11.6.1.10. Dispenser Position

**Option: 10 to 150 mm**

User can select the height for the dispenser head to be positioned at during titration (140 mm - default option).

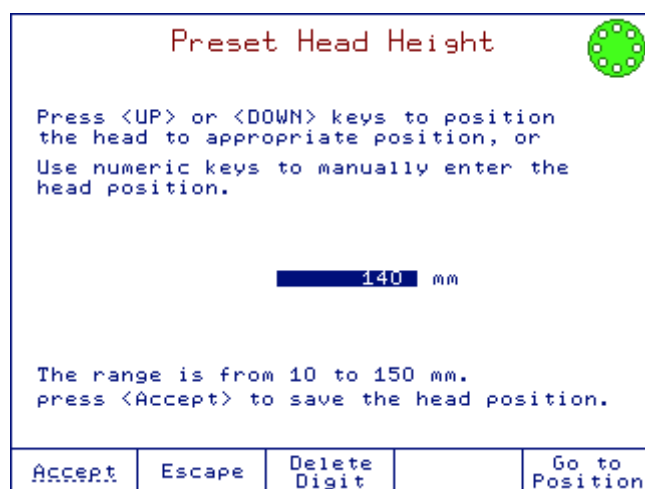

### 11.6.1.11. Head Up Wait Time

**Option: 1 to 30 seconds**

User can set the time for the autosampler to wait, with the dispenser head in the up position to catch any residual droplets, before moving on to the next sample or rinse beaker.

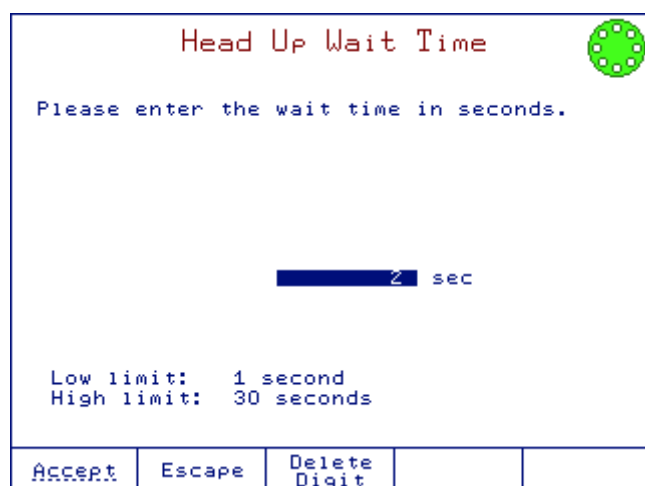

## 11.6.1.12. Sample Aspiration

**Option:** Disabled, Aspirate Only, Aspirate / Spray Rinse

Reacted samples may be aspirated into a waste container after each titration.

**Note:** Sample aspiration requires one peristaltic pump to be configured for aspiration, using [HI920-203 Tubing Set for Aspiration](#).

The screenshot shows a terminal window titled "Aspirate Sample" with a green status icon in the top right. The text "Select the option to be modified." is displayed. A dropdown menu for "Aspiration Option:" is open, showing three options: "Disabled" (highlighted), "Aspirate Only", and "Aspirate/Spray Rinse". At the bottom of the window, there are five buttons: "Select", "Escape", and three empty buttons.

Select the aspiration mode:

**Aspiration Only:** The existing waste from the sample beaker will be removed according to the parameters defined in this menu.

**Aspirate / Spray:** Reserved for future

## 11.6.1.12.1. Aspiration Pump

**Option:** Disabled, Auxiliary Pump 1, Auxiliary Pump 2, Auxiliary Pump 3

Select the peristaltic pump that is connected to the aspiration tube.

The screenshot shows a terminal window titled "Aspirate Sample" with a green status icon in the top right. The text "Select the option to be modified." is displayed. A dropdown menu for "Aspiration Pump:" is open, showing four options: "Disabled" (highlighted), "Aux Pump 1", "Aux Pump 2", and "Aux Pump 3". Other menu items visible include "Aspiration Option: Aspirate Only", "Aspiration Time:", and "Head Height:". At the bottom of the window, there are five buttons: "Select", "Escape", and three empty buttons.

### 11.6.1.12.2. Aspiration Time

**Option: 1 to 300 seconds**

Set the duration that the peristaltic pump will run.

Aspiration Time 				
Enter the period of time for running auxiliary pump.				
15 sec				
Low limit: 1 second High limit: 300 seconds				
Accept	Escape	Delete Digit		

### 11.6.1.12.3. Dispenser Head Height

**Option: 10 to 150 mm**

Set the height for the dispenser head. The aspiration tube should be positioned such that it reaches the bottom of the sample beaker when the dispenser head is positioned in the range of 10 to 150 mm.

Preset Head Height 				
Press <UP> or <DOWN> keys to position the head to appropriate position, or Use numeric keys to manually enter the head position.				
140 mm				
The range is from 10 to 150 mm. press <Accept> to save the head position.				
Accept	Escape	Delete Digit		Go to Position

## 11.6.1.13. Rinse

The autosampler can perform a dip rinse function after each analysis. Up to three dip rinses can be performed in a dedicated rinse beaker dip-rinse function.

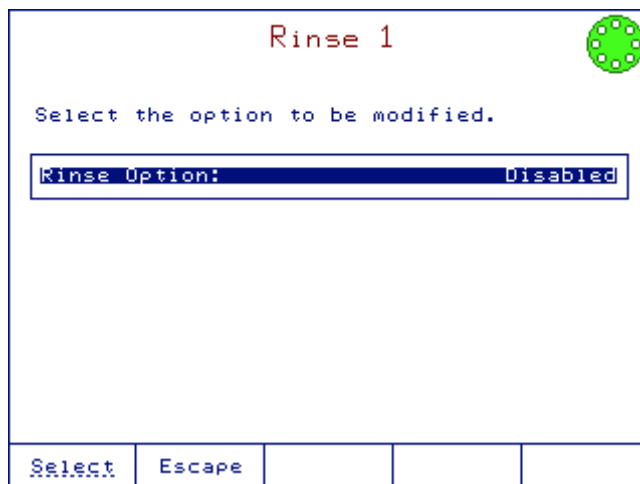

**Dip rinse** Dip rinse option can be used after each analysis to clean the electrodes and stirrer of contaminants, using dedicated rinsing beakers.

**Spray Rinse** Reserved for future

## 11.6.1.13.1. Rinse Beaker

Select the tray position for the dedicated rinse beaker.

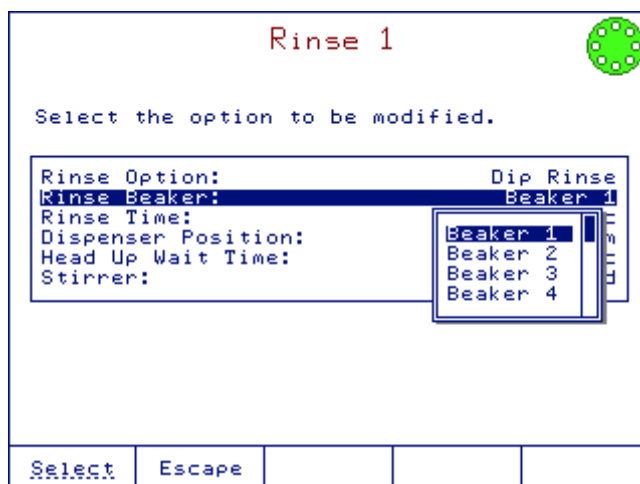

**Note:** If the selected beaker is already in use for buffer, standard or calibration rinse, it will be removed from the sample table.

## 11.6.1.13.2. Rinse Time

Option: 1 to 300 seconds

Rinse Time 				
Enter the period of time you would like to remain in the rinse beaker.				
10 sec				
Low limit: 1 second High limit: 300 seconds				
Accept	Escape	Delete Digit		

## 11.6.1.13.3. Dispenser Position

Option: 10 to 150 mm

Set the height for the dispenser head during rinsing.

Preset Head Height 				
Press <UP> or <DOWN> keys to position the head to appropriate position, or Use numeric keys to manually enter the head position.				
140 mm				
The range is from 10 to 150 mm. press <Accept> to save the head position.				
Accept	Escape	Delete Digit		Go to Position

## 11.6.1.13.4. Head Up Wait Time

Option: 1 to 300 seconds

Set the duration that the autosampler will wait with the dispenser in the up position for any drops of solution to fall off of the electrodes or stirrer before moving to another sample or rinse beaker.

Head Up Wait Time 				
Please enter the stirring time in seconds.				
1 sec				
Low limit: 1 second High limit: 300 seconds				
Accept	Escape	Delete Digit		

## 11.6.1.13.5. Stirrer

## Option: Enabled or Disabled

Select if the stirrer will run during rinsing.

Rinse 1				
Select the option to be modified.				
Rinse Option:	Dip Rinse			
Rinse Beaker:	Beaker 1			
Rinse Time:	10 sec			
Dispenser Position:	140 mm			
Head Up Wait Time:	1 sec			
Stirrer:	Enabled			
<input type="checkbox"/> Disabled <input checked="" type="checkbox"/> Enabled				
Select	Escape			

## 11.6.1.14. Calibration Rinse

The user can select to enable the rinse option during pH calibrations.

Calibration Rinse				
Select the option to be modified.				
Rinse Option:	Enabled			
Rinse Time:	10 sec			
Dispenser Position:	140 mm			
Head Up Wait Time:	1 sec			
Stirrer:	Enabled			
Select	Escape			

## 11.6.1.14.1. Rinse Option

## Option: Enabled or Disabled

Calibration Rinse				
Select the option to be modified.				
Rinse Option:	Enabled			
Rinse Time:				
Dispenser Position:	<input type="checkbox"/> Disabled <input checked="" type="checkbox"/> Enabled			
Head Up Wait Time:				
Stirrer:				
Select	Escape			

## 11.6.1.14.2. Rinse Time

Option: 1 to 300 seconds

Rinse Time 				
Enter the period of time you would like to remain in the rinse beaker.				
10 sec				
Low limit: 1 second High limit: 300 seconds				
Accept	Escape	Delete Digit		

## 11.6.1.14.3. Dispenser Position

Option: 10 to 150 mm

Set the height for the dispenser head during rinsing.

Preset Head Height 				
Press <UP> or <DOWN> keys to position the head to appropriate position, or Use numeric keys to manually enter the head position.				
140 mm				
The range is from 10 to 150 mm. press <Accept> to save the head position.				
Accept	Escape	Delete Digit		Go to Position

## 11.6.1.14.4. Head Up Wait Time

Option: 1 to 300 seconds

Set the duration that the autosampler will wait with the dispenser in the up position for any drops of solution to fall off of the electrodes or stirrer before moving to another sample or rinse beaker.

Head Up Wait Time 				
Please enter the stirring time in seconds.				
1 sec				
Low limit: 1 second High limit: 300 seconds				
Accept	Escape	Delete Digit		

## 11.6.1.14.5. Stirrer

## Option: Enabled or Disabled

Select if the stirrer will run during rinsing.

The screenshot shows a terminal window titled "Rinse 1" with a green status indicator in the top right corner. The text "Select the option to be modified." is displayed. A list of options is shown with "Stirrer:" highlighted. A small dialog box is open over the "Stirrer:" option, showing "Disabled" and "Enabled" with "Enabled" selected. At the bottom of the terminal window, there are five buttons: "Select", "Escape", and three empty buttons.

```

Rinse 1
Select the option to be modified.
Rinse Option:          Dip Rinse
Rinse Beaker:         Beaker 1
Rinse Time:           10 sec
Dispenser Position:   140 mm
Head Up Wait Time:    1 sec
Stirrer:              Enabled
  
```

Disabled  
Enabled

Select Escape

## 11.6.1.15. Clear Calibration at Start

## Option: Prompt, Yes, No

The screenshot shows a terminal window titled "View / Modify Sequence" with a green status indicator in the top right corner. The text "Select the option to be modified." is displayed. A list of options is shown with "Clear Cal at Start:" highlighted. A small dialog box is open over the "Clear Cal at Start:" option, showing "Prompt", "Yes", and "No" with "Prompt" selected. At the bottom of the terminal window, there are five buttons: "Select", "Escape", and three empty buttons.

```

View / Modify Sequence
Id: SEQ0002   Modified: 16:31 Nov 25, 2019
Select the option to be modified.
Stirrer Type:          Overhead
Missing Beaker Behavior: Stop
pH Setup:
Edit Sample Table:
Dispenser Position:   140 mm
Head Up Wait Time:    1 sec
Aspirate Sample:
Rinse 1:
Rinse 2:
Rinse 3:
Calibration Rinse:
Clear Cal at Start:   Yes
  
```

Prompt  
Yes  
No

Select Escape

<b>Prompt</b>	Prompts the user to clear the calibration when the sequence starts
<b>Yes</b>	Always clear the old calibration
<b>No</b>	The new calibration data will be merged with the old data



### 11.6.1.16. Minimum Calibration Stability Time

Option: 1 to 600 seconds

<b>Min. Cal Stability Time</b> 				
Please enter the minimum calibration stability time in seconds.				
██████████ 1 sec				
Low limit: 1 second High limit: 600 seconds				
Accept	Escape	Delete Digit		

### 11.6.1.17. Beaker Height

Option: 30 to 120 mm

Set the height of the beaker being used on the autosampler.

<b>Beaker Height</b> 				
Enter the beaker height in mm.				
██████████ 100 mm				
Low limit: 30 mm High limit: 120 mm				
Accept	Escape	Delete Digit		



### 11.6.2. RUNNING pH CALIBRATION SEQUENCE

The sequence can be started by pressing the  key.

**Note:** If the Calibration Rinse option is enabled, the beaker used for rinsing are positioned before beaker used for buffer calibration.

Edit Sample Table 

#	Name
1	Storage
2	Rinse04.010
3	pH04.010Hanna
4	Rinse07.010
5	pH07.010Hanna
6	Rinse10.010
7	pH10.010Hanna
8	----
9	----
10	----
11	----
12	----

Edit Buffer	Escape	Delete Buffer		
-------------	--------	---------------	--	--

15:02:46 Oct 06, 2019 

Default pH Sequence

----- pH  
Sequence Starting

Manual  
25.0 °C

#	Name	Result
1	Storage	
2	Rinse04.010	
3	pH04.010Hanna	
4	Rinse07.010	
5	pH07.010Hanna	
6	Rinse10.010	

--	--	--	--	--

The autosampler will process each calibration point according to the settings in sequence options.

While the autosampler is running, the top part of the screen shows the calibration information, and the bottom part of the screen shows a portion of the sample table.

The sample in progress is marked with symbol in the sample table.

Use the  and  keys to scroll the sample table.

Press  to pause the current calibration.

Press  to stop the calibration.

15:33:18 Oct 06, 2019 TRAY0024

Default pH Sequence

----- pH  
Sequence Suspended

Hanna  
4.010

Manual  
25.0 °C

#	Name	Result
1	Storage	
2	Rinse04.010	Suspended
3	pH04.010Hanna	
4	Rinse07.010	
5	pH07.010Hanna	
6	Rinse10.010	

Resume

15:33:27 Oct 06, 2019 TRAY0024

Default pH Sequence

----- pH  
Manually Terminated

Hanna  
4.010

Manual  
25.0 °C

#	Name	Result
1	Storage	
2	Rinse04.010	Stopped
3	pH04.010Hanna	Rns. Stopped
4	Rinse07.010	
5	pH07.010Hanna	
6	Rinse10.010	

Suspend

At the end of the sequence "Sequence Completed" will be displayed. The "Result" column will display the status for each beaker.

15:12:26 Oct 06, 2019 TRAY0024

Default pH Sequence



Sequence Completed

#	Name	Result
1	Storage	
2	Rinse04.010	Rinsed
3	pH04.010Hanna	Calibrated
4	Rinse07.010	Rinsed
5	pH07.010Hanna	Calibrated
6	Rinse10.010	Rinsed
7	pH10.010Hanna	Calibrated
8	----	
9	----	
10	----	
11	----	
12	----	

View GLP Clear Results AutoSmp. Setup

**Note:** If errors will appear during calibration the sequence will stop.

### 11.6.3. RESULTS





Press  to view pH GLP Data or the  key for more information.

pH GLP Data			
Analog 2			
Last Calibration:	15:12 Oct 06, 2019		
Offset:	0.5 mV	Average Slope:	100.1%
4.010pH (Hanna)	177.3mV	25.0°C	M
	15:09:25 Oct 06, 2019		
7.010pH (Hanna)	-0.1mV	25.0°C	M
	15:10:40 Oct 06, 2019		
10.010pH (Hanna)	-177.9mV	25.0°C	M
	15:12:05 Oct 06, 2019		
Escape			

Review Result		
TRAY0033.RPT		
2 Rinse04.010	Rinsed	15:09:22
3 pH04.010Hanna	Calibrated	15:09:25
4 Rinse07.010	Rinsed	15:10:25
5 pH07.010Hanna	Calibrated	15:10:40
6 Rinse10.010	Rinsed	15:12:01
7 pH10.010Hanna	Calibrated	15:12:05
-----		
GLP Data		
-----		
Last Calibration:	15:12 Oct 06, 2019	
Offset:	0.5 mV	
Average Slope:	100.1%	
4.010pH (Hanna)	177.3mV	25.0°C M
Escape    Print Report    Page Up    Page Down		

## 11.7. ISE CALIBRATION

### 11.7.1. VIEW / MODIFY SEQUENCE

To modify the sequence options, press  from the main screen. A list of all the parameters for the selected sequence will be displayed. Using the  and  keys, highlight the option you want to modify and press .

View / Modify Sequence	
Id: SEQ0003	Modified: 18:41 Dec 06, 2019
Select the option to be modified.	
Sequence Name:	Default ISE Sequence
Revision Number:	1.0
Comments:	
Sequence Type:	ISE Calibration
Analog Board:	Analog 1
Stirrer Type:	Overhead
Missing Beaker Behavior:	Stop
ISE Setup:	
Edit Sample Table:	
Reagent Addition 1:	Disabled
Dispenser Position:	140 mm
Head Up Wait Time:	1 sec
Select	Escape    Print Sequence    Page Up    Page Down

To exit the View / Modify Sequence screen, press .

You can choose to save the modifications or to discard them.

Saving Sequence

Select a menu option.

Save Sequence  
 Exit Without Saving Sequence

"Escape" - exit without saving sequence.

Select	Escape			
--------	--------	--	--	--

### 11.7.1.1. Sequence Name

Option: Up to 24 characters

Sequence Name

Select the highlighted letter by using the arrow keys then press "Enter".  
 Select the empty field for a space.  
 Press Accept to save the entered text.

█	A	B	C	D	E	F	G	H	I	J	K	L
M	N	O	P	Q	R	S	T	U	V	W	X	Y
Z	a	b	c	d	e	f	g	h	i	j	k	l
m	n	o	p	q	r	s	t	u	v	w	x	y
z	À	Á	Â	Ã	Ä	Å	Ç	È	É	Ê	Ë	Ì
Í	Î	Ï	Ñ	Ò	Ó	Ô	Õ	Ö	ß	à	á	â
ã	ä	å	è	é	ê	ë	ì	í	î	ï	ò	ó
ô	õ	ö	ù	ú	û	ü	¿	¡	*	\	_	\$
'	^	#	:	0	1	2	3	4	5	6	7	8
9	%	.	,	?	!	(	)	[	]	<	>	=
/	+	-										

ISE Calibration

Accept	Escape	Delete Letter	Cursor Left	Cursor Right
--------	--------	---------------	-------------	--------------

### 11.7.1.2. Revision Number

Option: Up to 3 characters

Revision Number

Select the highlighted letter by using the arrow keys then press "Enter".  
 Select the empty field for a space.  
 Press Accept to save the entered text.

█	A	B	C	D	E	F	G	H	I	J	K	L
M	N	O	P	Q	R	S	T	U	V	W	X	Y
Z	a	b	c	d	e	f	g	h	i	j	k	l
m	n	o	p	q	r	s	t	u	v	w	x	y
z	À	Á	Â	Ã	Ä	Å	Ç	È	É	Ê	Ë	Ì
Í	Î	Ï	Ñ	Ò	Ó	Ô	Õ	Ö	ß	à	á	â
ã	ä	å	è	é	ê	ë	ì	í	î	ï	ò	ó
ô	õ	ö	ù	ú	û	ü	¿	¡	*	\	_	\$
'	^	#	:	0	1	2	3	4	5	6	7	8
9	%	.	,	?	!	(	)	[	]	<	>	=
/	+	-										

1.0

Accept	Escape	Delete Letter	Cursor Left	Cursor Right
--------	--------	---------------	-------------	--------------

## 11.7.1.3. Comments

Option: Up to 20 characters

Comments 

Select the highlighted letter by using the arrow keys then press "Enter".  
Select the empty field for a space.  
Press Accept to save the entered text.

█	A	B	C	D	E	F	G	H	I	J	K	L
M	N	O	P	Q	R	S	T	U	V	W	X	Y
Z	a	b	c	d	e	f	g	h	i	j	k	l
m	n	o	p	q	r	s	t	u	v	w	x	y
z	À	Á	Â	Ã	Ä	Å	Æ	Ç	È	É	Ê	Ë
Ì	Í	Î	Ï	Ð	Ñ	Ò	Ó	Ô	Õ	Ö	×	Ø
Ù	Ú	Û	Ü	Ý	Þ	ß	à	á	â	ã	ä	å
æ	ç	è	é	ê	ë	ì	í	î	ï	ð	ñ	ò
ó	ô	õ	ö	÷	¸	¹	º	»	¼	½	¾	¿
0	1	2	3	4	5	6	7	8	9	×	.	:
?	!	(	)	[	]	<	>	=	/	+	-	,

Accept	Escape	Delete Letter	Cursor Left	Cursor Right
--------	--------	---------------	-------------	--------------

## 11.7.1.4. Sequence Type

Option: Sample Analysis, pH Calibration, ISE Calibration

View / Modify Sequence 

Id: SEQ0003      Modified: 18:41 Dec 06, 2019  
Select the option to be modified.

Sequence Name:	Default ISE Sequence
Revision Number:	1.0
Comments:	
Sequence Type:	ISE Calibration
Analog Board:	1
Stirrer Type:	d
Missing Beaker Behavior:	p
ISE Setup:	
Edit Sample Table:	
Reagent Addition 1:	Disabled
Dispenser Position:	140 mm
Head Up Wait Time:	1 sec

Select	Escape			
--------	--------	--	--	--

## 11.7.1.5. Analog Board

Option: Analog 1 or Analog 2 (if installed)

View / Modify Sequence 

Id: SEQ0003      Modified: 18:41 Dec 06, 2019  
Select the option to be modified.

Sequence Name:	Default ISE Sequence
Revision Number:	1.0
Comments:	
Sequence Type:	ISE Calibration
Analog Board:	Analog 1
Stirrer Type:	d
Missing Beaker Behavior:	p
ISE Setup:	
Edit Sample Table:	
Reagent Addition 1:	Disabled
Dispenser Position:	140 mm
Head Up Wait Time:	1 sec

Select	Escape			
--------	--------	--	--	--

## 11.7.1.6. Stirrer Type

Option: Overhead or Magnetic

View / Modify Sequence

Id: SEQ0003 Modified: 18:41 Dec 06, 2019  
Select the option to be modified.

Sequence Name:	Default ISE Sequence
Revision Number:	1.0
Comments:	
Sequence Type:	ISE Calibration
Analog Board:	Analog 1
Stirrer Type:	Overhead
Missing Beaker Behavior:	Overhead
ISE Setup:	Magnetic
Edit Sample Table:	
Reagent Addition 1:	
Dispenser Position:	140 mm
Head Up Wait Time:	1 sec

Select Escape

## 11.7.1.7. Missing Beaker Behavior

Option: Pause, Stop

Select type of behaviour when beaker detection is enabled and no beaker is detected.

View / Modify Sequence

Id: SEQ0003 Modified: 18:41 Dec 06, 2019  
Select the option to be modified.

Sequence Name:	Default ISE Sequence
Revision Number:	1.0
Comments:	
Sequence Type:	ISE Calibration
Analog Board:	Analog 1
Stirrer Type:	Overhead
Missing Beaker Behavior:	Stop
ISE Setup:	Pause
Edit Sample Table:	Stop
Reagent Addition 1:	
Dispenser Position:	
Head Up Wait Time:	1 sec

Select Escape

**Pause** The autosampler will pause the sequence at the current beaker and wait for the user before continuing the analysis.

**Stop** All operations will stop and the analysis will be stopped.



### 11.7.1.8. ISE Setup

This option allows the user to select ISE Setup menu. See [8.2. ISE SETUP](#) section for more information.

View / Modify Sequence 

Id: SEQ0003      Modified: 18:41 Dec 06, 2019  
 Select the option to be modified.

Sequence Name:	Default ISE Sequence
Revision Number:	1.0
Comments:	
Sequence Type:	ISE Calibration
Analog Board:	Analog 1
Stirrer Type:	Overhead
Missing Beaker Behavior:	Stop
<b>ISE Setup:</b>	
Edit Sample Table:	
Reagent Addition 1:	Disabled
Dispenser Position:	140 mm
Head Up Wait Time:	1 sec

Select	Escape	Print Sequence	Page Up	Page Down
--------	--------	----------------	---------	-----------

ISE Setup

Select a menu option.

Calibration Group:	All Standards
Temperature Compensation:	Disabled
Isopotential Point:	None
Edit Custom Standards:	
Edit Standards Group:	
Calibration Reminder:	Disabled
Set Reminder Period:	Disabled
Clear Calibration	
ISE GLP Data	
Electrode Type:	Iodide
Concentration Unit:	ppm
Logging Interval:	Disabled
Stability Criteria:	Medium

Select	Escape			
--------	--------	--	--	--

### 11.7.1.9. Edit Sample Table

This option allows to add, remove and edit the calibration beakers in the tray.

Edit Sample Table 

#	Name
1	Storage
2	Rinse1.00E-1
3	ISE1.00E-1
4	Rinse1.00
5	ISE1.00
6	Rinse10.0
7	ISE10.0
8	Rinse100
9	ISE100
10	----
11	----
12	----

Edit Standard	Escape	Delete Standard		
---------------	--------	-----------------	--	--

**Note:** Up to five calibration beakers can be added. Highlighted beakers have already been added to the calibration sequence.

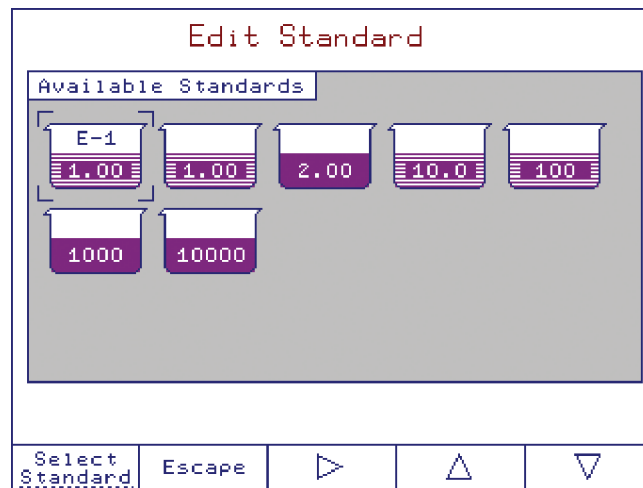

#### 11.7.1.10. Dispenser Position

##### Option: 10 to 150 mm

User can select the height for the dispenser head to be positioned at during titration (140 mm - default option).

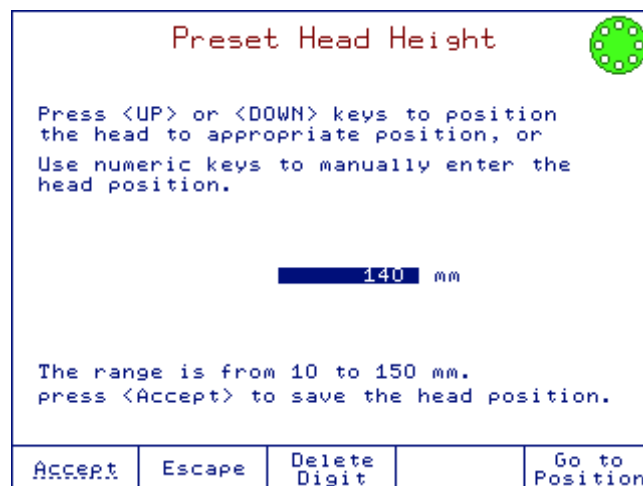

#### 11.7.1.11. Head Up Wait Time

##### Option: 1 to 30 seconds

User can set the time for the autosampler to wait, with the dispenser head in the up position to catch any residual droplets, before moving on to the next sample or rinse beaker.

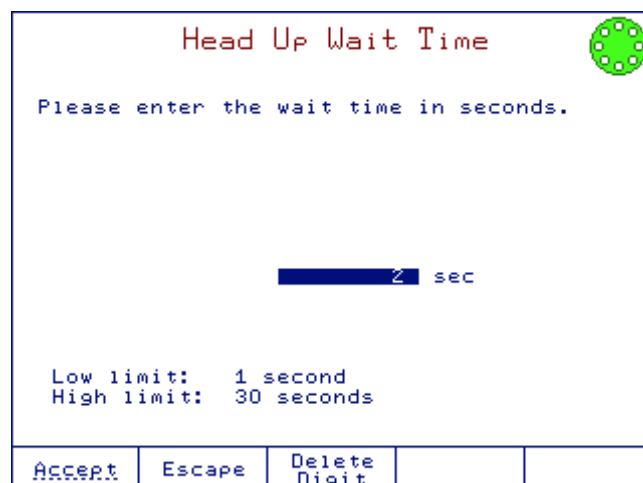

### 11.7.1.12. Sample Aspiration

**Option:** Disabled, Aspirate Only, Aspirate / Spray Rinse

Reacted samples may be aspirated into a waste container after each titration.

**Note:** Sample aspiration requires one peristaltic pump to be configured for aspiration, using [HI920-203 Tubing Set for Aspiration](#).

The screenshot shows a terminal-style interface titled "Aspirate Sample" with a green circular icon in the top right corner. Below the title, it says "Select the option to be modified." A menu box is open, showing "Aspiration Option:" followed by a dropdown list. The dropdown list contains three options: "Disabled" (highlighted), "Aspirate Only", and "Aspirate/Spray Rinse". At the bottom of the screen, there are five buttons: "Select", "Escape", and three empty buttons.

Select the aspiration mode:

**Aspiration Only:** The existing waste from the sample beaker will be removed according to the parameters defined in this menu.

**Aspirate / Spray:** Reserved for future

#### 11.7.1.12.1. Aspiration Pump

**Option:** Disabled, Auxiliary Pump 1, Auxiliary Pump 2, Auxiliary Pump 3

Select the peristaltic pump that is connected to the aspiration tube.

The screenshot shows a terminal-style interface titled "Aspirate Sample" with a green circular icon in the top right corner. Below the title, it says "Select the option to be modified." A menu box is open, showing several options: "Aspiration Option:" (set to "Aspirate Only"), "Aspiration Pump:" (set to "Disabled"), "Aspiration Time:", and "Head Height:". A dropdown list is open for "Aspiration Pump:", showing four options: "Disabled" (highlighted), "Aux Pump 1", "Aux Pump 2", and "Aux Pump 3". At the bottom of the screen, there are five buttons: "Select", "Escape", and three empty buttons.

## 11.7.1.12.2. Aspiration Time

Option: 1 to 300 seconds

Set the duration that the peristaltic pump will run.

Aspiration Time 				
Enter the period of time for running auxiliary pump.				
15 sec				
Low limit: 1 second High limit: 300 seconds				
Accept	Escape	Delete Digit		

## 11.7.1.12.3. Dispenser Head Height

Option: 10 to 150 mm

Set the height for the dispenser head. The aspiration tube should be positioned such that it reaches the bottom of the sample beaker when the dispenser head is positioned in the range of 10 to 150 mm.

Preset Head Height 				
Press <UP> or <DOWN> keys to position the head to appropriate position, or Use numeric keys to manually enter the head position.				
140 mm				
The range is from 10 to 150 mm. press <Accept> to save the head position.				
Accept	Escape	Delete Digit		Go to Position

### 11.7.1.13. Rinse

The autosampler can perform a dip rinse function after each analysis. Up to three dip rinses can be performed in a dedicated rinse beaker dip-rinse function.

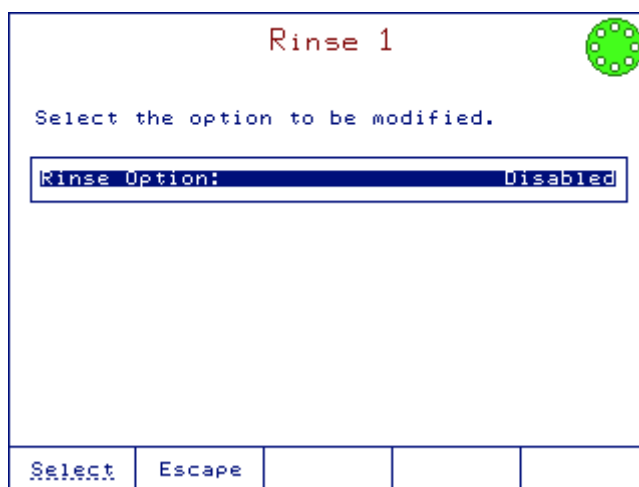

**Dip rinse** Dip rinse option can be used after each analysis to clean the electrodes and stirrer of contaminants, using dedicated rinsing beakers.

**Spray Rinse** Reserved for future

#### 11.7.1.13.1. Rinse Beaker

Select the tray position for the dedicated rinse beaker.

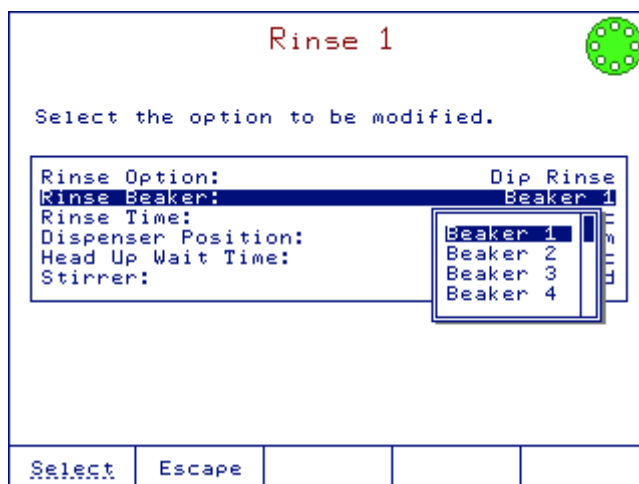

**Note:** If the selected beaker is already in use for buffer, standard or calibration rinse, it will be removed from the sample table.

## 11.7.1.13.2. Rinse Time

Option: 1 to 300 seconds

Rinse Time 				
Enter the period of time you would like to remain in the rinse beaker.				
10 sec				
Low limit: 1 second High limit: 300 seconds				
Accept	Escape	Delete Digit		

## 11.7.1.13.3. Dispenser Position

Option: 10 to 150 mm

Set the height for the dispenser head during rinsing.

Preset Head Height 				
Press <UP> or <DOWN> keys to position the head to appropriate position, or Use numeric keys to manually enter the head position.				
140 mm				
The range is from 10 to 150 mm. press <Accept> to save the head position.				
Accept	Escape	Delete Digit		Go to Position

#### 11.7.1.13.4. Head Up Wait Time

**Option: 1 to 300 seconds**

Set the duration that the autosampler will wait with the dispenser in the up position for any drops of solution to fall off of the electrodes / stirrer before moving to another sample or rinse beaker.

**Head Up Wait Time**

Please enter the stirring time in seconds.

1 sec

Low limit: 1 second  
High limit: 300 seconds

Accept	Escape	Delete Digit	
--------	--------	--------------	--

#### 11.7.1.13.5. Stirrer

**Option: Enabled or Disabled**

Select if the stirrer will run during rinsing.

**Rinse 1**

Select the option to be modified.

Rinse Option:	Dip Rinse
Rinse Beaker:	Beaker 1
Rinse Time:	10 sec
Dispenser Position:	140 mm
Head Up Wait Time:	1 sec
Stirrer:	Enabled

Disabled  
 Enabled

Select	Escape		
--------	--------	--	--

## 11.7.1.14. Calibration Rinse

The user can select to enable the rinse option during ISE calibrations.

Calibration Rinse 														
Select the option to be modified.														
<table border="1"> <tr> <td>Rinse Option:</td> <td>Enabled</td> </tr> <tr> <td>Rinse Time:</td> <td>10 sec</td> </tr> <tr> <td>Dispenser Position:</td> <td>140 mm</td> </tr> <tr> <td>Head Up Wait Time:</td> <td>1 sec</td> </tr> <tr> <td>Stirrer:</td> <td>Enabled</td> </tr> </table>					Rinse Option:	Enabled	Rinse Time:	10 sec	Dispenser Position:	140 mm	Head Up Wait Time:	1 sec	Stirrer:	Enabled
Rinse Option:	Enabled													
Rinse Time:	10 sec													
Dispenser Position:	140 mm													
Head Up Wait Time:	1 sec													
Stirrer:	Enabled													
Select	Escape													

## 11.7.1.14.1. Rinse Option

Option: Enabled or Disabled

Calibration Rinse 														
Select the option to be modified.														
<table border="1"> <tr> <td>Rinse Option:</td> <td>Enabled</td> </tr> <tr> <td>Rinse Time:</td> <td></td> </tr> <tr> <td>Dispenser Position:</td> <td></td> </tr> <tr> <td>Head Up Wait Time:</td> <td></td> </tr> <tr> <td>Stirrer:</td> <td></td> </tr> </table>					Rinse Option:	Enabled	Rinse Time:		Dispenser Position:		Head Up Wait Time:		Stirrer:	
Rinse Option:	Enabled													
Rinse Time:														
Dispenser Position:														
Head Up Wait Time:														
Stirrer:														
Select	Escape													

## 11.7.1.14.2. Rinse Time

Option: 1 to 300 seconds

Rinse Time 						
Enter the period of time you would like to remain in the rinse beaker.						
<table border="1"> <tr> <td>10</td> <td>sec</td> </tr> </table>					10	sec
10	sec					
Low limit: 1 second High limit: 300 seconds						
Accept	Escape	Delete Digit				



### 11.7.1.14.3. Dispenser Position

**Option: 10 to 150 mm**

Set the height for the dispenser head during rinsing.

Preset Head Height 				
Press <UP> or <DOWN> keys to position the head to appropriate position, or Use numeric keys to manually enter the head position.				
140 mm				
The range is from 10 to 150 mm. press <Accept> to save the head position.				
Accept	Escape	Delete Digit		Go to Position

### 11.7.1.14.4. Head Up Wait Time

**Option: 1 to 300 seconds**

Set the duration that the autosampler will wait with the dispenser in the up position for any drops of solution to fall off of the electrodes or stirrer before moving to another sample or rinse beaker.

Head Up Wait Time 				
Please enter the stirring time in seconds.				
1 sec				
Low limit: 1 second High limit: 300 seconds				
Accept	Escape	Delete Digit		

## 11.7.1.14.5. Stirrer

## Option: Enabled or Disabled

Select if the stirrer will run during rinsing.

The screenshot shows a terminal window titled "Rinse 1" with a green status icon in the top right. The text "Select the option to be modified." is displayed. A list of options is shown with their current values: Rinse Option: Dip Rinse, Rinse Beaker: Beaker 1, Rinse Time: 10 sec, Dispenser Position: 140 mm, Head Up Wait Time: 1 sec, and Stirrer: Enabled. A small dialog box is open over the "Stirrer" option, showing "Disabled" and "Enabled" with "Enabled" selected. At the bottom, there are buttons for "Select", "Escape", and three empty buttons.

## 11.7.1.15. Clear Calibration at Start

## Option: Prompt, Yes, No

The screenshot shows a terminal window titled "View / Modify Sequence" with a green status icon in the top right. The text "Id: SEQ0003 Modified: 19:42 Dec 06, 2019" and "Select the option to be modified." is displayed. A list of options is shown with their current values: Missing Beaker Behavior: Stop, ISE Setup: (blank), Edit Sample Table: (blank), Reagent Addition 1: Disabled, Dispenser Position: 140 mm, Head Up Wait Time: 1 sec, Aspirate Sample: (blank), Rinse 1: (blank), Rinse 2: (blank), Rinse 3: (blank), Calibration Rinse: (blank), and Clear Cal at Start: Yes. A small dialog box is open over the "Clear Cal at Start" option, showing "Prompt", "Yes", and "No" with "Yes" selected. At the bottom, there are buttons for "Select", "Escape", and three empty buttons.

- Prompt** Prompts the user to clear the calibration when the sequence starts
- Yes** Always clear the old calibration
- No** The new calibration data will be merged with the old data

## 11.7.1.16. Minimum Calibration Stability Time

Option: 1 to 600 seconds

Min. Cal Stability Time				
Please enter the minimum calibration stability time in seconds.				
1 sec				
Low limit: 1 second High limit: 600 seconds				
Accept	Escape	Delete Digit		

## 11.7.1.17. Beaker Height

Option: 30 to 120 mm

Set the height of the beaker being used on the autosampler.

Beaker Height				
Enter the beaker height in mm.				
100 mm				
Low limit: 30 mm High limit: 120 mm				
Accept	Escape	Delete Digit		

## 11.7.1.18. Position when Finished

Option: Home, Standard, Storage

View / Modify Sequence				
Id: SEQ0003    Modified: 16:31 Nov 25, 2019				
Select the option to be modified.				
Reagent Addition 1:	Disabled			
Dispenser Position:	140 mm			
Head Up Wait Time:	1 sec			
Aspirate Sample:	Disabled			
Rinse 1:	Disabled			
Rinse 2:	Disabled			
Rinse 3:	Disabled			
Calibration Rinse:	Home			
Clear Cal at Start:	Standard			
Min. Cal Stability Time:	Storage			
Beaker Height:				
Position when finished:	Storage			
Select	Escape			



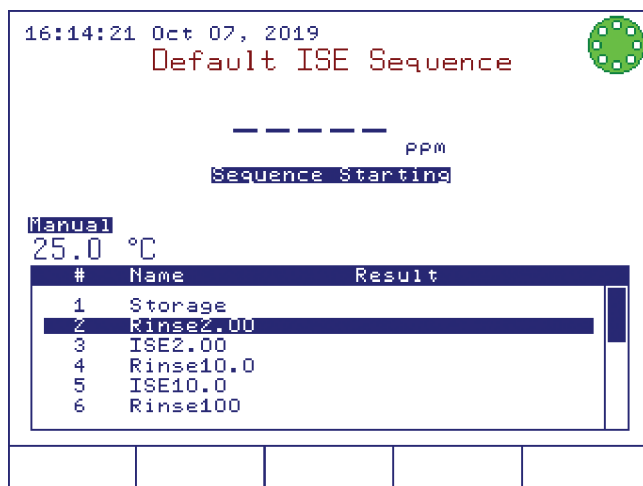

The autosampler will process each calibration point according to the settings in sequence options.

While the autosampler is running, the top part of the screen shows the calibration information, and the bottom part of the screen shows a portion of the sample table.

The sample in progress is marked with symbol in the sample table.

Use the and keys to scroll the sample table.

Press  to pause the current calibration.

Press  to stop the calibration.

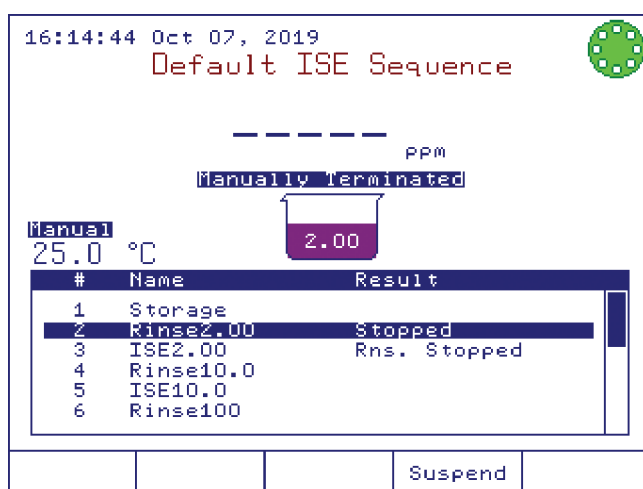
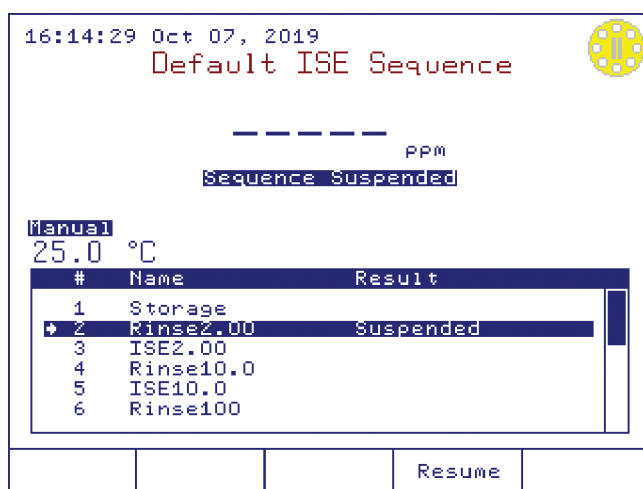

At the end of the sequence "Sequence Completed" will be displayed. The "Result" column will display the status for each beaker.

#	Name	Result
1	Storage	
2	Rinse2.00	Rinsed
3	ISE2.00	Calibrated
4	Rinse10.0	Rinsed
5	ISE10.0	Calibrated
6	Rinse100	Rinsed
7	ISE100	Calibrated
8	----	
9	----	
10	----	
11	----	
12	----	

16:50:32 Oct 07, 2019 TRAY0029  
Default ISE Sequence  
Sequence Completed

View GLP. Clear Results AutoSmp. Setup

*Note: If errors will appear during calibration the sequence will stop.*

### 11.7.3. RESULTS

Press  to view ISE GLP Data or the  key for more information.

ISE GLP Data			
Analog 2			
Last Calibration:	16:50	Oct 07, 2019	ISE: Iodide
Slope:	100.1%		
2.00 ppm,	73.6mV	25.0°C	M
	16:48:01	Oct 07, 2019	
10.0 ppm,	32.3mV	25.0°C	M
	16:49:17	Oct 07, 2019	
100 ppm,	-27.1mV	25.0°C	M
	16:50:32	Oct 07, 2019	

Escape

Review Result			
TRAY0036.RPT			
2 Rinse2.00	Rinsed	16:47:01	
3 ISE2.00	Calibrated	16:47:26	
4 Rinse10.0	Rinsed	16:48:17	
5 ISE10.0	Calibrated	16:48:42	
6 Rinse100	Rinsed	16:49:32	
7 ISE100	Calibrated	16:49:57	
-----			
GLP Data			
-----			
Last Calibration:	16:50	Oct 07, 2019	
Average Slope:	100.1%		
ISE:	Iodide		
2.00 ppm	73.6mV	25.0°C	M

Escape Print Report Page Up Page Down

## 12. ACCESSORIES

### 12.1. SOLUTIONS

#### 12.1.1. pH CALIBRATION BUFFERS

HI7001M	pH 1.68 buffer solution, 230 mL
HI7001L	pH 1.68 buffer solution, 500 mL
HI7004M	pH 4.01 buffer solution, 230 mL
HI7004L	pH 4.01 buffer solution, 500 mL
HI7006M	pH 6.86 buffer solution, 230 mL
HI7006L	pH 6.86 buffer solution, 500 mL
HI7007M	pH 7.01 buffer solution, 230 mL
HI7007L	pH 7.01 buffer solution, 500 mL
HI7009M	pH 9.18 buffer solution, 230 mL
HI7009L	pH 9.18 buffer solution, 500 mL
HI7010M	pH 10.01 buffer solution, 230 mL
HI7010L	pH 10.01 buffer solution, 500 mL

#### 12.1.2. pH CALIBRATION BUFFERS IN FDA APPROVED BOTTLE

HI8004L	pH 4.01 buffer solution, 500 mL
HI8006L	pH 6.86 buffer solution, 500 mL
HI8007L	pH 7.01 buffer solution, 500 mL
HI8009L	pH 9.18 buffer solution, 500 mL
HI8010L	pH 10.01 buffer solution, 500 mL

#### 12.1.3. pH TECHNICAL CALIBRATION BUFFERS

HI5016	pH 1.68 buffer solution, 500 mL
HI5003	pH 3.00 buffer solution, 500 mL
HI5004	pH 4.01 buffer solution, 500 mL
HI5068	pH 6.86 buffer solution, 500 mL
HI5007	pH 7.01 buffer solution, 500 mL
HI5091	pH 9.18 buffer solution, 500 mL
HI5010	pH 10.01 buffer solution, 500 mL
HI5124	pH 12.45 buffer solution, 500 mL

#### 12.1.4. pH MILLESIMAL CALIBRATION BUFFERS

HI6016	pH 1.679 buffer solution, 500 mL
HI6016-01	pH 1.679 buffer solution, 1 L
HI6003	pH 3.000 buffer solution, 500 mL
HI6003-01	pH 3.000 buffer solution, 1 L
HI6004	pH 4.010 buffer solution, 500 mL
HI6004-01	pH 4.010 buffer solution, 1 L
HI6068	pH 6.862 buffer solution, 500 mL
HI6068-01	pH 6.862 buffer solution, 1 L
HI6007	pH 7.010 buffer solution, 500 mL

HI6007-01	pH 7.010 buffer solution, 1 L
HI6091	pH 9.177 buffer solution, 500 mL
HI6091-01	pH 9.177 buffer solution, 1 L
HI6010	pH 10.010 buffer solution, 500 mL
HI6010-01	pH 10.010 buffer solution, 1 L
HI6124	pH 12.450 buffer solution, 500 mL
HI6124-01	pH 12.450 buffer solution, 1 L

#### 12.1.5. ELECTRODE CLEANING SOLUTIONS

HI7061M	General purpose cleaning solution, 230 mL
HI7061L	General purpose cleaning solution, 500 mL
HI7073M	Protein cleaning solution, 230 mL
HI7073L	Protein cleaning solution, 500 mL
HI7074M	Inorganic cleaning solution, 230 mL
HI7074L	Inorganic cleaning solution, 500 mL
HI7077M	Oil & fat cleaning solution, 230 mL
HI7077L	Oil & fat cleaning solution, 500 mL

#### 12.1.6. ELECTRODE CLEANING SOLUTIONS IN FDA APPROVED BOTTLE

HI8061M	General purpose solution, 230 mL
HI8061L	General purpose solution, 500 mL
HI8073M	Protein cleaning solution, 230 mL
HI8073L	Protein cleaning solution, 500 mL
HI8077M	Oil & fat cleaning solution, 230 mL
HI8077L	Oil & fat cleaning solution, 500 mL

#### 12.1.7. ELECTRODE STORAGE SOLUTIONS

HI70300M	Storage solution, 230 mL
HI70300L	Storage solution, 500 mL

#### 12.1.8. ELECTRODE STORAGE SOLUTIONS IN FDA APPROVED BOTTLE

HI80300M	Storage solution, 230 mL
HI80300L	Storage solution, 500 mL

#### 12.1.9. ELECTRODE REFILL ELECTROLYTE SOLUTIONS

HI7071	3.5 M KCl with AgCl Reference Electrolyte Solution, 30 mL
HI7072	1 M Potassium Nitrate Electrode Fill Solution
HI7075	1.7 M Potassium Nitrate, 0.7 M Potassium Chloride Electrode Fill Solution
HI7076	1 M Sodium Chloride Electrode Fill Solution
HI7078	0.5 M Ammonium Sulfate Electrode Fill Solution
HI7082	3.5 M KCl Reference Electrolyte Solution, 30 mL

#### 12.1.10. ELECTRODE REFILL ELECTROLYTE SOLUTIONS IN FDA APPROVED BOTTLE

HI8071	3.5 M KCl with AgCl Reference Electrolyte Solution, 30 mL
HI8072	1 M Potassium Nitrate Electrode Fill Solution
HI8082	3.5 M KCl Reference Electrolyte Solution, 30 mL



**12.1.11. ORP PRETREATMENT SOLUTIONS**

HI7091M	Reducing pretreatment solution, 230 mL
HI7091L	Reducing pretreatment solution, 500 mL
HI7092M	Oxidizing pretreatment solution, 230 mL
HI7092L	Oxidizing pretreatment solution, 500 mL

**12.1.12. TITRATION REAGENTS**

HI70429	0.05 M Silver nitrate titration reagent, 1 L
HI70433	0.01 N Stabilized iodine titration reagent, 1 L
HI70439	0.1 M Sodium thiosulfate titration reagent, 1 L
HI70440	0.02 N Stabilized iodine titration reagent, 1 L
HI70441	0.04 N Stabilized iodine titration reagent, 1 L
HI70448	0.02 M Silver nitrate titration reagent, 1 L
HI70449	0.02 M EDTA titration reagent, 1 L
HI70455	0.01 N Sodium hydroxide titration reagent, 1 L
HI70456	0.1 N Sodium hydroxide titration reagent, 1 L
HI70457	1 N Sodium hydroxide titration reagent, 1 L
HI70458	0.01 M Sulfuric acid titration reagent, 1 L
HI70459	0.05 M Sulfuric acid titration reagent, 1 L
HI70462	0.01 N Hydrochloric acid titration reagent, 1 L
HI70463	0.1 N Hydrochloric acid titration reagent, 1 L
HI70464	1 N Hydrochloric acid titration reagent, 1 L

**12.1.13. ION-SELECTIVE ELECTRODE CALIBRATION STANDARDS**

HI4001-01	0.1 M Ammonia standard
HI4001-02	100 ppm Ammonia standard (as N)
HI4001-03	1000 ppm Ammonia standard (as N)
HI4002-01	0.1 M Bromide standard
HI4003-01	0.1 M Cadmium standard
HI4004-01	0.1 M Calcium standard
HI4005-01	0.1 M Carbon dioxide standard
HI4005-03	1000 ppm Carbon dioxide standard (as CaCO <sub>3</sub> )
HI4007-01	0.1 M Chloride standard
HI4007-02	100 ppm Chloride standard
HI4007-03	1000 ppm Chloride standard
HI4008-01	0.1 M Cupric standard
HI4010-01	0.1 M Fluoride standard
HI4010-02	100 ppm Fluoride standard
HI4010-03	1000 ppm Fluoride standard
HI4011-01	0.1 M Iodide standard
HI4012-01	0.1 M Lead standard
HI4012-21	0.1 M Sulfate standard
HI4013-01	0.1 M Nitrate standard

HI4013-02	100 ppm Nitrate standard
HI4013-03	1000 ppm Nitrate standard
HI4014-01	0.1 M Potassium standard
HI4015-01	0.1 M Silver standard

## 12.2. SENSORS

### 12.2.1. pH ELECTRODES

#### HI1043B

Glass-body, double junction, refillable, combination pH electrode

Use: strong acid and base, paint and solvents

#### HI1053B

Glass-body, triple ceramic, conic shape, refillable, combination pH electrode

Use: emulsions, fats and creams, soil and semi-solids samples

#### HI1083B

Glass-body, micro, Viscolene, nonrefillable, combination pH electrode

Use: biotechnology and micro titration

#### HI1131B

Glass-body, double junction, refillable, combination pH electrode

Use: general purpose

#### HI1330B

Glass-body, semimicro, single junction, refillable, combination pH electrode

Use: laboratory, vials, and test tubes

#### HI1331B

Glass-body, semimicro, single junction, refillable, combination pH electrode

Use: flasks

#### HI1230B

Plastic-body (PEI), double junction, gel-filled, combination pH electrode

Use: general purpose

#### HI2031B

Glass-body, conical tip, refillable, combination pH electrode

Use: dairy and semi-solid products

#### HI1332B

Plastic-body (PEI), double junction, refillable, combination pH electrode

Use: chemicals, field applications and quality control testing

#### FC100B

Plastic-body (PVDF), double junction, refillable, combination pH electrode

Use: cheese

#### FC200B

Plastic-body (PVDF), single junction, conical tip, non-refillable Viscolene electrolyte, combination pH electrode

Use: milk, yogurt, dairy products, and semi-solid foods

#### FC210B

Glass-body, double junction, conical tip, non-refillable Viscolene electrolyte, combination pH electrode

Use: milk, yogurt, and cream

#### **FC220B**

Glass-body, single junction, refillable, combination pH electrode

Use: milk, yogurt, cream, sauce, and fruit juices

#### **FC911B**

Plastic-body (PVDF), double junction, refillable, combination pH electrode

Use: sauce, juices, dairy products and other liquid or slurry forms of food

#### **HI1413B**

Glass-body, single junction, flat tip, non-refillable Viscolene electrolyte, combination pH electrode

Use: surfaces, skin, leather, paper, and emulsions

### **12.2.2. ORP ELECTRODES**

#### **HI3131B**

Glass-body, refillable, combination platinum ORP electrode

Use: laboratories and general purpose

#### **HI3230B**

Plastic-body (PEI), gel-filled, combination platinum ORP electrode

Use: municipal water and quality control

#### **HI4430B**

Plastic-body (PEI), gel-filled, combination gold ORP electrode

Use: oxidants and ozone

### **12.2.3. HALF-CELL ELECTRODES**

#### **HI2110B**

Glass-body, single half-cell pH electrode

Use: general purpose

#### **HI5311**

Glass-body, silver / silver chloride (Ag / AgCl) reference half-cell electrode, double junction, refillable with 4mm banana plug with 1m (3.3') cable

Use: general purpose with wide temperature range

#### **HI5315**

Plastic-body (PEI), double junction, silver / silver chloride (Ag / AgCl) reference half-cell electrode, refillable with 4mm plug with 1 m (3.3') cable.

Use: Ion-Selective Electrodes

#### **HI5412**

Glass-body, single Calomel reference half-cell electrode, refillable with 4mm plug with 1m (3.3') cable

Use: general purpose with constant temperature range

### **12.2.4. ION-SELECTIVE ELECTRODES**

<b>HI4101</b>	Ammonia ion selective electrode
<b>HI4002 / HI4102</b>	Bromide ion selective electrode
<b>HI4003 / HI4103</b>	Cadmium ion selective electrode
<b>HI4004 / HI4104</b>	Chloride ion selective electrode
<b>HI4105</b>	Carbon dioxide ion selective electrode

HI4007 / HI4107	Chloride ion selective electrode
HI4008 / HI4108	Cupric ion selective electrode
HI4009 / HI4109	Cyanide ion selective electrode
HI4010 / HI4110	Fluoride ion selective electrode
HI4011 / HI4111	Iodide ion selective electrode
HI4012 / HI4112	Lead ion selective electrode
HI4013 / HI4113	Nitrate ion selective electrode
HI4014 / HI4114	Potassium ion selective electrode
HI4015 / HI4115	Silver / Sulfide ion selective electrode
FC300B	Sodium electrode

#### 12.2.5. TEMPERATURE SENSOR

##### HI7662-TW

Temperature probe with 1 m (3.3') paneled cable

## 12.3. TITRATOR COMPONENTS

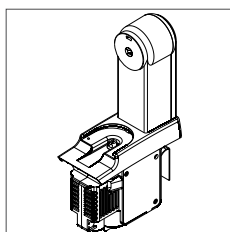

Pump assembly  
HI930100

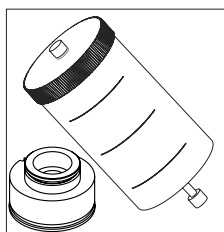

50 mL Syringe  
HI900250

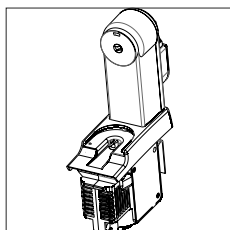

Pump assembly with  
peristaltic pump  
HI930101

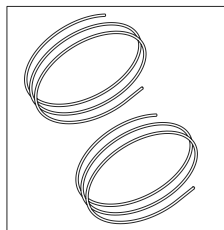

Titrator peristaltic pump complete  
tubing set  
HI930202

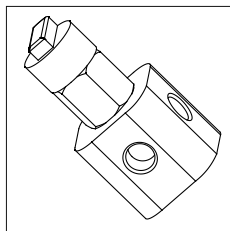

3 Way valve  
HI900260

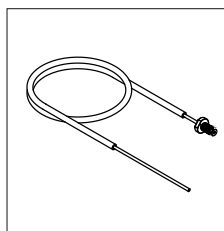

Aspiration tube with fitting and  
protection tube  
HI900270

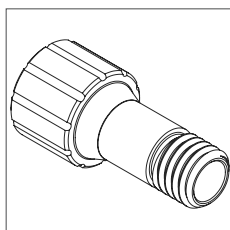

Tool for burette cap removal  
HI900942

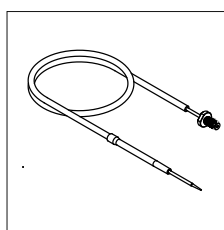

Dispensing tube with dispensing  
tip, fitting, protection tube and  
tube guide  
HI930280

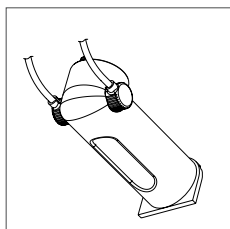

Burette with:  
5 mL syringe - HI930105  
10 mL syringe - HI930110  
25 mL syringe - HI930125  
50 mL syringe - HI930150

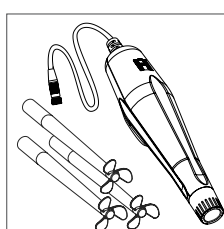

Overhead stirrer &  
3 propellers  
HI930301

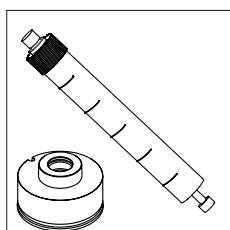

5 mL Syringe  
HI900205

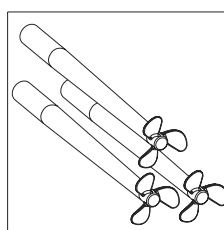

Replacement propellers  
(3 pcs.)  
HI930302

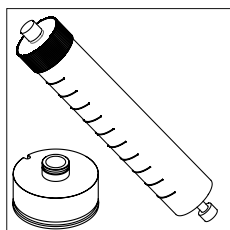

10 mL Syringe  
HI900210

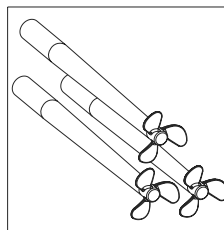

High chemical resistance  
propellers  
(3 pcs.)  
HI930303

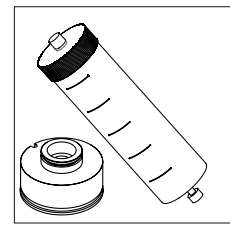

25 mL Syringe  
HI900225

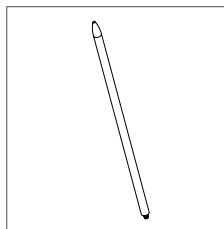

Stirrer support  
HI930320

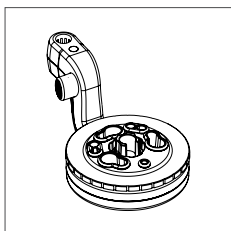

Overhead electrode holder  
HI930310

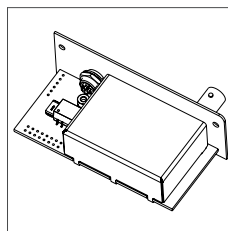

Potentiometric analog board  
HI930401

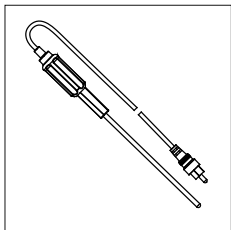

Temperature probe  
HI7662-TW

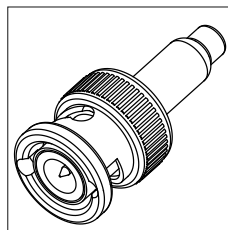

Shorting cap  
HI900945

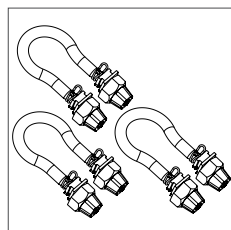

Roller tube for titrator  
peristaltic pump (3 pcs.)  
HI930204

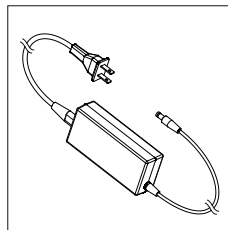

Power adapter (usa plug)  
HI900946

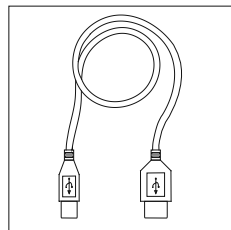

USB Cable  
HI920013

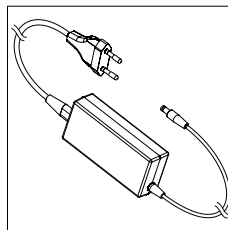

Power adapter (european plug)  
HI900947

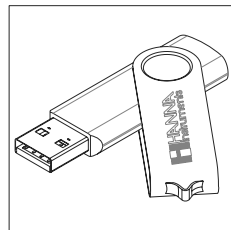

USB Storage device  
HI930900U

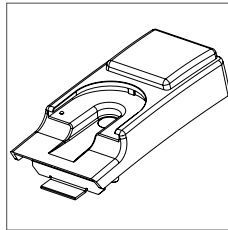

Blank burette support  
HI930190

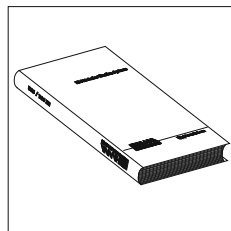

Instruction manual binder  
HI930801

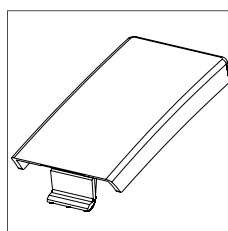

Blank support  
HI930191

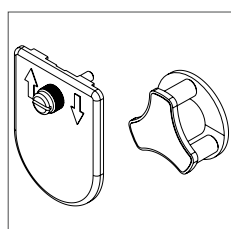

Replacement cap and rotor  
for peristaltic pump  
HI930201

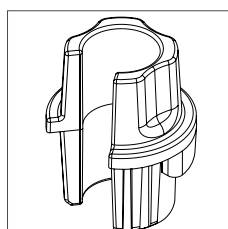

Electrode adapter for overhead  
stirrer holder  
HI930311

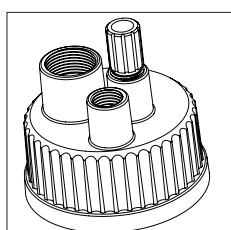

Titrant bottle cap assembly  
HI930330

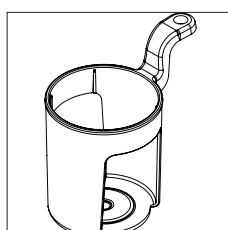

Titrant bottle holder  
HI930315

## 12.4. AUTOSAMPLER COMPONENTS

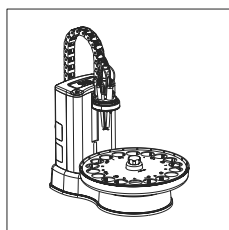

Autosampler  
HI922 - XYZ

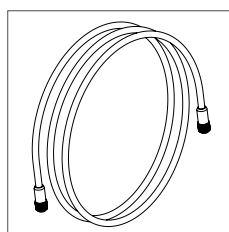

Communication cable  
HI920-933  
(HI932 to HI921 / HI922)

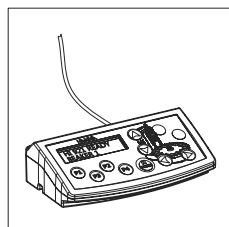

Control panel  
HI920-922

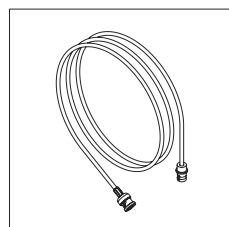

BNC Extension cable (1 m)  
HI920-931

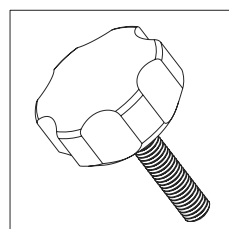

Tray locking screw  
HI920-960

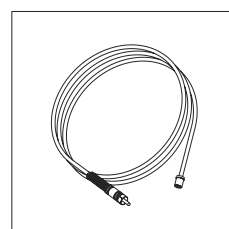

Reference extension cable (1 m)  
HI920-932

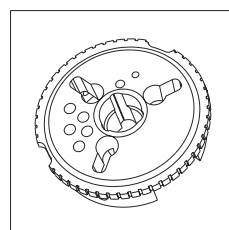

Electrode holder  
HI920-310

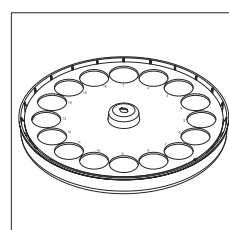

16 beaker tray, 60 mm dia.  
Single row with RFID  
HI920-11660W

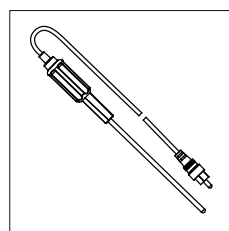

Temperature sensor  
HI7662-AW

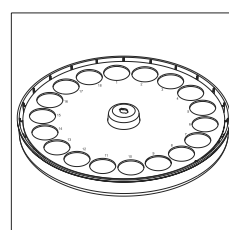

18 beaker tray, 53 mm dia.  
Single row with RFID  
HI920-11853W

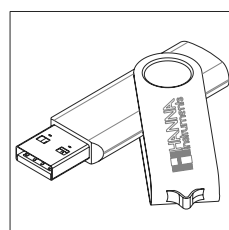

USB Memory stick  
HI920-901

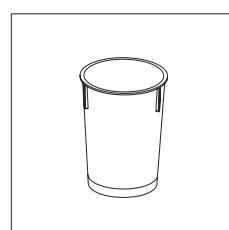

Plastic Beaker for  
HI920-11660 (20 pcs.)  
HI920-060

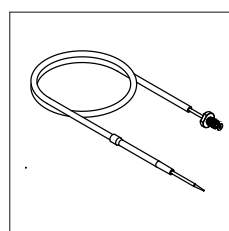

Titrant dispensing tube  
(1.5 m)  
HI920-281

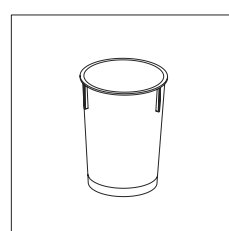

Plastic beaker for  
HI920-11853 (20 pcs.)  
HI920-053

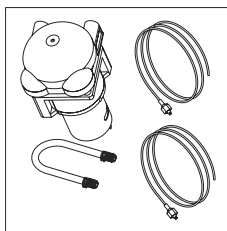

Peristaltic Pump with  
dispensing tubing  
**HI920-103**

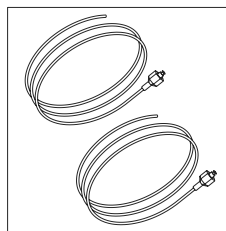

Membrane Pump Complete  
Tubing Set  
**HI920-212**

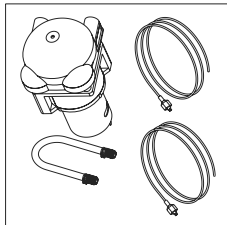

Peristaltic pump with  
aspiration tubing  
**HI920-104**

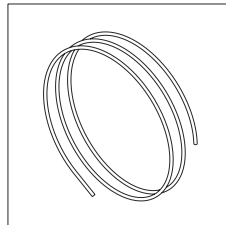

TYGON Tube (5 m)  
**HI920-290**

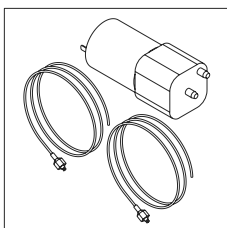

Membrane Pump with tubing  
**HI920-113**

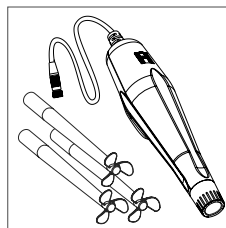

Overhead Stirrer + 3 propellers  
**HI930301**

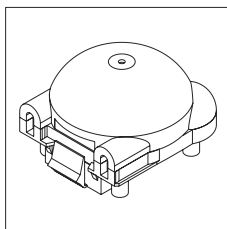

Replacement Cap and Rotor  
for Peristaltic Pump  
**HI920-201**

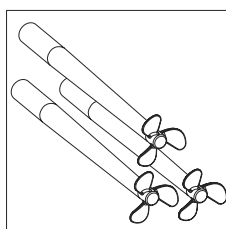

Replacement Propellers (3 pcs.)  
**HI930302**

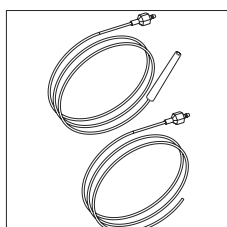

Tubing Set with plastic  
dispensing tube guide for  
peristaltic pump  
**HI920-208**

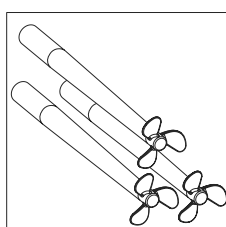

High Chemical Resistance  
Propellers (3 pcs.)  
**HI930303**

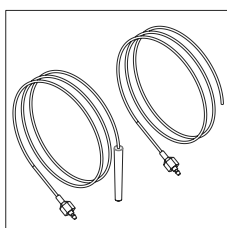

Tubing Set with stainless  
steel aspiration tube for  
peristaltic pump  
**HI920-203**

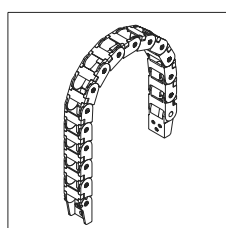

Cable Chain  
**HI920-320**

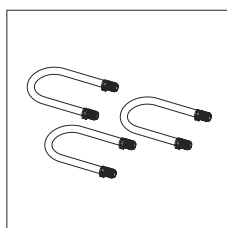

Roller Tube for Autosampler  
peristaltic pump (3 pcs.)  
**HI920-204**

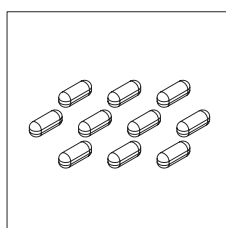

25 mm x 7 mm Stir Bars  
(10 pcs.)  
**HI731319**

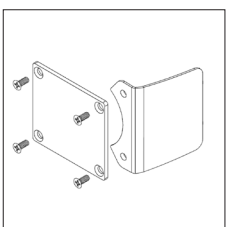

Pump covers  
**HI920-191**



## PART 3:

## APPLICATIONS



## HI0001EN 0.1N SODIUM HYDROXIDE TITRANT CONCENTRATION

### DESCRIPTION

Method for the standardization (titer determination) of 0.1N Sodium Hydroxide (NaOH) titrant solution against Potassium Hydrogen Phthalate (KHP). The results are expressed in **N (eq/L)**.

### REFERENCE

AOAC Official Methods of Analysis, Official Method 936.16

### ELECTRODE

- HI1131B Combination pH Electrode
- HI7662-T Temperature Probe

### REAGENTS

- HI70456 0.1N Sodium Hydroxide (1 L)
- HI70401 Potassium Hydrogen Phthalate (20 g)
- HI70436 Deionized Water (1 gal)

### ACCESSORIES

- HI70300L Storage Solution (500 mL)
- HI7071 Electrode Fill Solution (30 mL x 4)
- HI7004L pH 4.01 Buffer Solution (500 mL)
- HI7007L pH 7.01 Buffer Solution (500 mL)
- HI7010L pH 10.01 Buffer Solution (500 mL)
- HI740036P 100 mL Plastic Beaker (10 pcs)
- Analytical Balance with 0.0001 g resolution

### DEVICE PREPARATION

- Connect the pH electrode and temperature probe to the titrator.
- Install a 25 mL burette filled with 0.1N sodium hydroxide (HI70456) on pump one and verify that no air bubbles are present in the burette or tubing. If necessary prime the burette until all the air has been removed completely.
- Press Select Method from the main screen. Use the arrow keys to highlight *HI0001EN 0.1N Sodium Hydroxide* and press Select.

### ELECTRODE PREPARATION

- Press Mode from the main screen, if necessary select the analog board and press pH.
- Calibrate the electrode using pH 4.01, 7.01 and 10.01 buffers. Refer to the instruction manual for calibration procedure.

### SAMPLE PREPARATION

- Crush approximately 3 grams of potassium hydrogen phthalate (HI70401) and dry it for 2 hours at 120°C. Cool to room temperature in a desiccator.
- Place a clean 100 mL plastic beaker on the analytical balance.
- Zero the balance.
- Carefully weigh approximately 0.20 grams of dried potassium hydrogen phthalate into the beaker. Ensure that all of the potassium hydrogen phthalate is on the bottom of the beaker.
- Record the exact weight of the sample once the balance has stabilized with an accuracy of 0.0001 grams.
- Remove the beaker from the balance and add deionized water to the 50 mL mark on the beaker.

### ANALYSIS

- Place the beaker under the stirrer assembly and lower it to immerse the pH electrode, temperature probe and stirrer. Ensure that the reference junction of the pH electrode is 5 to 6 mm below the surface. If necessary add extra deionized water.

**Note:** *The dispensing tip should be slightly submerged in the sample.*

- Press start stop. You will be prompted to enter the weight of the analyte (weight of potassium hydrogen phthalate). Use the numeric keypad to enter the exact weight and press enter to start the analysis.

**Note:** *Ensure that the potassium hydrogen phthalate dissolves completely during the pre-titration stir time. Erroneous results may occur if the sample does not dissolve completely prior to titration. If necessary the pre-titration stir time can be increased.*

- At the end of the titration, after detection of the equivalence point, "Titration Completed" will appear with the result. The result is expressed in **N (eq/L) of sodium hydroxide**.
- Remove the pH electrode, temperature probe and stirrer from the sample and rinse them thoroughly with deionized water.
- Record the result.

**Note:** For improved accuracy, repeat this procedure a minimum of three times and calculate the average value.

For methods utilizing 0.1N sodium hydroxide titrant solution, follow the steps below to enter the titer/standardized value.

- Select the method utilizing 0.1N sodium hydroxide.
- Press  from the main screen.

## METHOD PARAMETERS

Name: 0.1N Sodium Hydroxide  
 Method Revision: 3.0  
 Analysis Type: Standard Titration  
 Analog Board: Analog 1  
 Stirrer Configuration:  
   Stirrer: Stirrer 1  
   Stirring Speed: 1400 RPM  
 Pump Configuration:  
   Titrant Pump: Pump 1  
 Reagent Addition 1: Disabled  
 Reagent Addition 2: Disabled  
 Dosing Type: Dynamic  
   Min Vol: 0.030 mL  
   Max Vol: 0.500 mL  
   delta E: 4.500 mV  
 End Point Mode:pH 1EQ point, 1st Der  
 Recognition Options:  
   Threshold: 500 mV/mL  
   Range: NO  
   Filtered Derivatives: NO  
 Pre-Titration Volume: 5.000 mL  
 Pre-Titration Stir Time: 60 sec  
 Measurement Mode: Signal Stability  
   delta E: 0.3 mV  
   delta t: 2 sec  
   Min wait: 3 sec  
   Max wait: 30 sec  
 Electrode Type: pH  
 Blank Option: No Blank  
 Calculations:Stdz. Titrant by Weight  
 Dilution Option: Disabled  
 Titrant Name: 0.1N NaOH  
 Analyte Size: 0.20000 g  
 Analyte Entry: Manual  
 Maximum Titrant Volume: 15.000 mL  
 Potential Range:-2000.0 to 2000.0 mV  
 Volume/Flow Rate: 25 mL/50.0 mL/min  
 Signal Averaging: 1 Reading  
 Significant Figures: XXXXX

- Using the arrow keys, highlight Titrant Conc. and press .
- Use the numeric keypad to enter the standardized (titer) value of the titrant then press .
- Press  to exit the **View/Modify Method** screen. Use the arrow keys to highlight *Save Method* and press .

## CALCULATIONS

Calculations:Stdz. Titrant by Weight  
 Titrant units: N (eq/L)  
 Titrant volume dosed: V (L)  
 Standard weight: 0.200 g  
 mw of standard: 204.23 g/mol  
 Titrant/Standard: 1.000 eq/mol

$$\frac{\text{eq}}{\text{L}} \text{ NaOH} = \frac{0.200 * 1.000}{204.23 * \text{V(L)}}$$

## RESULTS

Titration Report  
 Method Name: 0.1N Sodium Hydroxide  
 Time & Date: 17:03 Jun 07, 2018  
 Report ID: Ti\_00053

Titration Results  
 Method Name: 0.1N Sodium Hydroxide  
 Time & Date: 17:03 Jun 07, 2018  
 Analyte Size: 0.20920 g  
 End Point Volume: 10.215 mL  
 pH Equivalence Point: 8.394  
 Result: 0.10027 N(eq/L)  
 Initial & Final pH: 4.173 to 9.570  
 Titration Duration: 6:25 [mm:ss]  
 Titration went to Completion

Analyst Signature: \_\_\_\_\_

## HI0002EN 0.1N HYDROCHLORIC ACID TITRANT CONCENTRATION

### DESCRIPTION

Method for the standardization (titer determination) of 0.1N Hydrochloric Acid (HCl) titrant solution against Sodium Hydroxide (NaOH). The results are expressed in **N (eq/L)**.

### REFERENCE

AOAC Official Methods of Analysis, Official Method 936.15

### ELECTRODE

- HI1131B Combination pH Electrode
- HI7662-T Temperature Probe

### REAGENTS

- HI70463 0.1N Hydrochloric Acid (1 L)
- HI70456 0.1N Sodium Hydroxide (1 L)
- HI70436 Deionized Water (1 gal)

### ACCESSORIES

- HI70300L Storage Solution (500 mL)
- HI7071 Electrode Fill Solution (30 mL x 4)
- HI7004L pH 4.01 Buffer Solution (500 mL)
- HI7007L pH 7.01 Buffer Solution (500 mL)
- HI7010L pH 10.01 Buffer Solution (500 mL)
- HI740036P 100 mL Plastic Beaker (10 pcs)
- 10 mL Class A Volumetric Pipette

### DEVICE PREPARATION

- Connect the pH electrode and temperature probe to the titrator.
- Install a 25 mL burette filled with 0.1N hydrochloric acid (HI70453) on pump one and verify that no air bubbles are present in the burette or tubing. If necessary prime the burette until all the air has been removed completely.
- Press  from the main screen. Use the arrow keys to highlight *HI0002EN 0.1N Hydrochloric Acid* and press .

### ELECTRODE PREPARATION

- Press  from the main screen, if necessary select the analog board and press .
- Calibrate the electrode using pH 4.01, 7.01 and 10.01 buffers. Refer to the instruction manual for calibration procedure.

### SAMPLE PREPARATION

- Use a Class A volumetric pipette to transfer exactly 10.00 mL of 0.1N sodium hydroxide (HI70456) to a clean 100 mL beaker
- Add deionized water to the 50 mL mark on the beaker.

### ANALYSIS

- Place the beaker under the stirrer assembly and lower it to immerse the pH electrode, temperature probe and stirrer. Ensure that the reference junction of the pH electrode is 5 to 6 mm below the surface. If necessary add extra deionized water.

**Note:** *The dispensing tip should be slightly submerged in the sample.*

- Press . The titrator start the analysis.
- At the end of the titration, after detection of the equivalence point, "Titration Completed" will appear with the result. The result is expressed in **N (eq/L) of hydrochloric acid**.
- Remove the pH electrode, temperature probe and stirrer from the sample and rinse them thoroughly with deionized water.
- Record the result.

**Note:** *For improved accuracy, repeat this procedure a minimum of three times and calculate the average value.*

**For methods utilizing 0.1N hydrochloric acid titrant solution, follow the steps below to enter the titer/standardized value.**

- Select the method utilizing 0.1N hydrochloric acid.
- Press  from the main screen.
- Using the arrow keys, highlight Titrant Conc. and press .
- Use the numeric keypad to enter the standardized (titer) value of the titrant then press .
- Press  to exit the **View/Modify Method** screen. Use the arrow keys to highlight *Save Method* and press .

## METHOD PARAMETERS

Name: 0.1N Hydrochloric Acid  
 Method Revision: 3.0  
 Analysis Type: Standard Titration  
 Analog Board: Analog 1  
 Stirrer Configuration:  
   Stirrer: Stirrer 1  
   Stirring Speed: 1400 RPM  
 Pump Configuration:  
   Titrant Pump: Pump 1  
 Reagent Addition 1: Disabled  
 Reagent Addition 2: Disabled  
 Dosing Type: Dynamic  
   Min Vol: 0.030 mL  
   Max Vol: 0.500 mL  
   delta E: 6.000 mV  
 End Point Mode:pH 1EQ point, 1st Der  
 Recognition Options:  
   Threshold: 500 mV/mL  
   Range: NO  
   Filtered Derivatives: NO  
 Pre-Titration Volume: 5.000 mL  
 Pre-Titration Stir Time: 0 sec  
 Measurement Mode: Signal Stability  
   delta E: 1.0 mV  
   delta t: 2 sec  
   Min wait: 3 sec  
   Max wait: 15 sec  
 Electrode Type: pH  
 Blank Option: No Blank  
 Calculations:Stdz. Titrant by Weight  
 Dilution Option: Disabled  
 Titrant Name: 0.1N HCl  
 Analyte Size: 10.0000 mL  
 Analyte Entry: Fixed  
 Maximum Titrant Volume: 15.000 mL  
 Potential Range:-2000.0 to 2000.0 mV  
 Volume/Flow Rate: 25 mL/50.0 mL/min  
 Signal Averaging: 1 Reading  
 Significant Figures: XXXXX

## CALCULATIONS

Calculations:Stdz. Titrant by Weight  
 Titrant units: N (eq/L)  
 Titrant volume dosed: V (L)  
 Standard volume: 10.000 mL  
 Standard conc.: 0.100 eq/L

$$\frac{\text{eq}}{\text{L}} \text{ HCl} = \frac{10.000 * 0.100}{\text{V(L)} * 1000}$$

## RESULTS

## Titration Report

Method Name: 0.1N Hydrochloric Acid  
 Time & Date: 14:55 July 30, 2018  
 Report ID: Ti\_00002

## Titration Results

Method Name: 0.1N Hydrochloric Acid  
 Time & Date: 14:55 July 30, 2018  
 Analyte Size: 10.000 mL  
 End Point Volume: 9.979 mL  
 pH Equivalence Point: 5.059  
 Result: 0.10020 N(eq/L)  
 Initial & Final pH: 12.135 to 4.989  
 Titration Duration: 2:45 [mm:ss]  
 Titration went to Completion

Analyst Signature: \_\_\_\_\_

## HI0003EN 0.1M SODIUM THIOSULFATE TITRANT CONCENTRATION

### DESCRIPTION

Method for the standardization (titer determination) of 0.1M Sodium Thiosulfate ( $\text{Na}_2\text{S}_2\text{O}_3$ ) titrant solution against Potassium Iodate ( $\text{KIO}_3$ ). The results are expressed in **M (mol/L)**.

### REFERENCE

Standard Methods for the Examination of Water and Wastewater 19<sup>th</sup> Edition, Method 4500-Cl B

### ELECTRODE

- HI3131B Combination ORP Electrode



### REAGENTS

- HI70439 0.1M Sodium Thiosulfate (1 L)
- HI70407 Potassium Iodate (20 g)
- HI70425 16% Sulfuric Acid (500 mL)
- HI70468 Potassium Iodide (35 g)
- HI70436 Deionized Water (1 gal)

### ACCESSORIES

- HI70300L Storage Solution (500 mL)
- HI7071 Electrode Fill Solution (30 mL x 4)
- HI740036P 100 mL Plastic Beakers (10 pcs)
- Analytical Balance 0.0001 g
- 100 mL Class A Volumetric Flask
- 10 mL Class A Volumetric Pipette

### DEVICE PREPARATION

- Connect the ORP electrode to the titrator.
- Install a 25 mL burette filled with 0.1M sodium thiosulfate (HI70439) on pump one and verify that no air bubbles are present in the burette or tubing. If necessary prime the burette until all the air has been removed completely.
- Press  from the main screen. Use the arrow keys to highlight *HI0003EN 0.1M Sodium Thiosulfate* and press .

### ELECTRODE PREPARATION

- Prepare the ORP electrode according to the procedure in the manual.

### SAMPLE PREPARATION



- Crush approximately 2 grams of potassium iodate (HI70407) and dry it for 2 hours at 120°C. Cool to room temperature in a desiccator.

- Carefully weigh approximately 0.35 grams of dried potassium iodate.
- Record the exact weight of the sample once the balance has stabilized with an accuracy of 0.0001 grams.
- Carefully transfer the salt to a 100 mL Class A volumetric flask. Add approximately 80 mL of deionized water, and mix to dissolve. Once the salt is completely dissolved bring the flask to volume with deionized water, mix well.
- Use a Class A volumetric pipette to transfer exactly 10.00 mL of the solution to a clean 100 mL plastic beaker.
- Add deionized water to the 50 mL mark on the beaker.
- Add 5.00 mL of 16% sulfuric acid (HI70425) and 1.5 grams of potassium iodide (HI70468) to the beaker.

### ANALYSIS

- Place the beaker under the stirrer assembly and lower it to immerse the ORP electrode and stirrer. Ensure that the reference junction of the ORP electrode is 5 to 6 mm below the surface. If necessary add extra deionized water.

**Note:** *The dispensing tip should be slightly submerged in the sample.*

- Press . You will be prompted to enter the weight of the analyte (weight of potassium iodate). Use the numeric keypad to enter the exact weight and press  to start the analysis.
- At the end of the titration, after detection of the equivalence point, "Titration Completed" will appear with the result. The result is expressed in **M (mol/L) of sodium thiosulfate**.
- Remove the ORP electrode and stirrer from the sample and rinse them thoroughly with deionized water.
- Record the result.

**Note:** *For improved accuracy, repeat this procedure a minimum of three times and calculate the average value.*

For methods utilizing 0.1M sodium thiosulfate titrant solution, follow the steps below to enter the titer/standardized value.

- Select the method utilizing 0.1M sodium thiosulfate.
- Press **Method Options** from the main screen.
- Using the arrow keys, highlight Titrant Conc. and press **Select**.

## METHOD PARAMETERS

```
Name:          0.1M Sodium Thiosulfate
Method Revision:      3.0
Analysis Type:   Standard Titration
Analog Board:      Analog 1
Stirrer Configuration:
  Stirrer:         Stirrer 1
  Stirring Speed:  1400 RPM
Pump Configuration:
  Titrant Pump:    Pump 1
Reagent Addition 1: Disabled
Reagent Addition 2: Disabled
Dosing Type:      Dynamic
  Min Vol:         0.030 mL
  Max Vol:         0.600 mL
  delta E:         6.500 mV
End Point Mode:mV 1EQ point, 1st Der
Recognition Options:
  Threshold:       50 mV/mL
  Range:           NO
  Filtered Derivatives: NO
Pre-Titration Volume:  5.000 mL
Pre-Titration Stir Time:  0 sec
Measurement Mode:   Signal Stability
  delta E:         0.3 mV
  delta t:         2 sec
  Min wait:        2 sec
  Max wait:        20 sec
Electrode Type:      ORP
Blank Option:        No Blank
Calculations:Stdz. Titrant by Weight
Dilution Option:    Enabled
  Final Dilution Volume: 100.000 mL
  Aliquot Volume:        10.000 mL
Titrant Name:        0.1M Na2S2O3
Analyte Size:        0.35000 g
Analyte Entry:       Manual
Maximum Titrant Volume: 15.000 mL
Potential Range:-2000.0 to 2000.0 mV
Volume/Flow Rate:   25 mL/50.0 mL/min
Signal Averaging:   1 Reading
Significant Figures: XXXXXX
```

- Use the numeric keypad to enter the standardized (titer) value of the titrant then press **Accept**.
- Press **Escape** to exit the **View/Modify Method** screen. Use the arrow keys to highlight **Save Method** and press **Select**.

## CALCULATIONS

```
Calculations:Stdz. Titrant by Weight
Titrant units:      M (mol/L)
Titrant volume dosed:  V (L)
Standard weight:    0.350 g
Dilution Factor:   0.100
  Final Dilution volume: 100.000 mL
  Aliquot Volume:        10.000 mL
mw of standard:     214.00 g/mol
Titrant/Standard:   6.000 mol/mol
```

$$\frac{\text{mol}}{\text{L}} \text{Na}_2\text{S}_2\text{O}_3 = \frac{0.350 * 0.10 * 6.0}{214.00 * V(L)}$$

## RESULTS

```
Titration Report
Method Name: 0.1M Sodium Thiosulfate
Time & Date: 17:03 Jun 07, 2018
Report ID:   Ti_00073
```

```
Titration Results
Method Name: 0.1M Sodium Thiosulfate
Time & Date: 17:03 Jun 07, 2018
Analyte Size: 0.35020 g
End Point Volume: 9.635 mL
mV Equivalence Point: 233.0
Result: 0.10191 M (mol/L)
Initial & Final mV: 361.8 to 173.4
Titration Duration: 2:51 [mm:ss]
Titration went to Completion
```

Analyst Signature: \_\_\_\_\_

## HI0010EN 0.1M FERROUS AMMONIUM SULFATE TITRANT CONCENTRATION

### DESCRIPTION

Method for the standardization (titer determination) of 0.1M Ferrous Ammonium Sulfate (FAS) titrant solution against Potassium Dichromate ( $K_2Cr_2O_7$ ). The results are expressed in **M (mol/L)**.

### REFERENCE

Standard Methods for the Examination of Water and Wastewater 21<sup>st</sup> Edition, Method 5220B

### ELECTRODE

- HI3131B Combination ORP Electrode

### REAGENTS

- HI70444 25% Sulfuric Acid
- HI70436 Deionized Water (1 gal)
- Ferrous Ammonium Sulfate (ACS Grade)
- Potassium Dichromate (ACS Grade)

### ACCESSORIES



- HI70300L Storage Solution (500 mL)
- HI7071 Electrode Fill Solution (30 mL x 4)
- HI740036P 100 mL Plastic Beakers (10 pcs)
- Analytical Balance with 0.0001 g resolution
- 100 mL Class A Volumetric Flask
- 500 mL Class A Volumetric Flask
- 10 mL Class A Volumetric Pipette

### TITRANT PREPARATION

- Carefully weigh 19.607 grams of ferrous ammonium sulfate.
- Carefully transfer the salt to a 500 mL Class A volumetric flask. Add approximately 300 mL of deionized water, and mix to dissolve.
- Add 40.00 mL of 25% sulfuric acid (HI70444) to the flask. Invert the solution to mix.
- Allow the flask to return to room temperature.
- Bring the flask to volume with deionized water, mix well.

### DEVICE PREPARATION

- Connect the ORP electrode to the titrator.
- Install a 25 mL burette filled with 0.1M ferrous ammonium sulfate on pump one and verify that no air bubbles are present in the burette or tubing. If necessary prime the burette until all the air has been removed completely.

- Press  from the main screen. Use the arrow keys to highlight *HI0010EN 0.1M FAS* and press .

### ELECTRODE PREPARATION

- Prepare the ORP electrode according to the procedure in the manual.



### SAMPLE PREPARATION

- Carefully weigh approximately 0.49 grams of dried potassium dichromate.
- Record the exact weight of the sample once the balance has stabilized with an accuracy of 0.0001 grams.
- Carefully transfer the salt to a 100 mL Class A volumetric flask. Add approximately 80 mL of deionized water, and mix to dissolve. Once the salt is completely dissolved bring the flask to volume with deionized water, mix well.
- Use a Class A volumetric pipette to transfer exactly 10.00 mL of the solution to a clean 100 mL plastic beaker.
- Add 25.00 mL of 25% sulfuric acid (HI70444) to the beaker.
- Add deionized water to the 50 mL mark on the beaker.

### ANALYSIS

- Place the beaker under the stirrer assembly and lower it to immerse the electrode and stirrer. Ensure that the reference junction of the ORP electrode is 5 to 6 mm below the surface. If necessary add extra deionized water.

**Note:** *The dispensing tip should be slightly submerged in the sample.*

- Press . You will be prompted to enter the weight of the analyte (weight of potassium dichromate). Use the numeric keypad to enter the exact weight and press  to start the analysis.
- At the end of the titration, after detection of the equivalence point, "Titration Completed" will appear with the result. The result is expressed in **M (mol/L) of ferrous ammonium sulfate**.
- Remove the ORP electrode and stirrer from the sample and rinse them thoroughly with deionized water.



- Record the result.

**Note:** For improved accuracy, repeat this procedure a minimum of three times and calculate the average value.

For methods utilizing 0.1M ferrous ammonium sulfate titrant solution, follow the steps below to enter the titer/standardized value.

- Select the method utilizing 0.1M ferrous ammonium sulfate.

## METHOD PARAMETERS

```
Name: 0.1M FAS
Method Revision: 3.0
Analysis Type: Standard Titration
Analog Board: Analog 1
Stirrer Configuration:
  Stirrer: Stirrer 1
  Stirring Speed: 1400 RPM
Pump Configuration:
  Titrant Pump: Pump 1
Reagent Addition 1: Disabled
Reagent Addition 2: Disabled
Dosing Type: Dynamic
  Min Vol: 0.030 mL
  Max Vol: 0.500 mL
  delta E: 4.500 mV
End Point Mode:mV 1EQ point, 1st Der
Recognition Options:
  Threshold: 35 mV/mL
  Range: NO
  Filtered Derivatives: NO
Pre-Titration Volume: 5.000 mL
Pre-Titration Stir Time: 0 sec
Measurement Mode: Signal Stability
  delta E: 0.5 mV
  delta t: 3 sec
  Min wait: 2 sec
  Max wait: 20 sec
Electrode Type: ORP
Blank Option: No Blank
Calculations:Stdz. Titrant by Weight
Dilution Option: Enabled
  Final Dilution Volume: 100.000 mL
  Aliquot Volume: 10.000 mL
Titrant Name: 0.1M FAS
Analyte Size: 0.49000 g
Analyte Entry: Manual
Maximum Titrant Volume: 15.000 mL
Potential Range:-2000.0 to 2000.0 mV
Volume/Flow Rate: 25 mL/50.0 mL/min
Signal Averaging: 1 Reading
Significant Figures: XXXXXX
```

- Press **Method Options** from the main screen.
- Using the arrow keys, highlight Titrant Conc. and press **Select**.
- Use the numeric keypad to enter the standardized (titer) value of the titrant then press **Accept**.
- Press **Escape** to exit the **View/Modify Method** screen. Use the arrow keys to highlight **Save Method** and press **Select**.

## CALCULATIONS

```
Calculations:Stdz. Titrant by Weight
Titrant units: M (mol/L)
Titrant volume dosed: V (L)
Standard weight: 0.490 g
Dilution Factor: 0.100
  Final Dilution volume: 100.000 mL
  Aliquot Volume: 10.000 mL
mw of standard: 294.18 g/mol
Titrant/Standard: 6.000 mol/mol
```

$$\frac{\text{mol}}{\text{L}} \text{ FAS} = \frac{0.490 * 0.10 * 6.0}{294.18 * V(L)}$$

## RESULTS

```
Titration Report
Method Name: 0.1M FAS
Time & Date: 15:59 August 1, 2018
Report ID: Ti_00015
```

```
Titration Results
Method Name: 0.1M FAS
Time & Date: 15:59 August 1, 2018
Analyte Size: 0.491 g
End Point Volume: 9.879 mL
mV Equivalence Point: 667.4
Result: 0.10137 M (mol/L)
Initial & Final mV: 791.3 to 598.0
Titration Duration: 3:05 [mm:ss]
Titration went to Completion
```

Analyst Signature: \_\_\_\_\_

## HI0200EN 0.02M SILVER NITRATE TITRANT CONCENTRATION

### DESCRIPTION

Method for the standardization (titer determination) of 0.02M Silver Nitrate ( $\text{AgNO}_3$ ) titrant solution against Sodium Chloride ( $\text{NaCl}$ ). The results are expressed in **M (mol/L)**.

### REFERENCE

AOAC Official Methods of Analysis, Official Method 941.18

### ELECTRODE

- HI4115 Silver/Sulfide Combination ISE



### REAGENTS

- HI70448 0.02M Silver Nitrate (1 L)
- HI70406 Sodium Chloride (20 g)
- HI70427 1.5M Nitric Acid Solution (500 mL)
- HI70436 Deionized Water (1 gal)

### ACCESSORIES

- HI7072 Electrode Fill Solution (4 x 30 mL)
- Analytical Balance with 0.0001 g resolution
- 150 mL Glass Beaker
- 100 mL Class A Volumetric Flask
- 5 mL Class A Volumetric Pipette

### DEVICE PREPARATION

- Connect the Silver/Sulfide electrode to the titrator.
- Install a 25 mL burette filled with 0.02M silver nitrate (HI70448) on pump one and verify that no air bubbles are present in the burette or tubing. If necessary prime the burette until all the air has been removed completely.
- Press  from the main screen. Use the arrow keys to highlight *HI0200EN 0.02M Silver Nitrate* and press .

### ELECTRODE PREPARATION

- Prepare the Silver/Sulfide electrode according to the procedure in the manual.

### SAMPLE PREPARATION



- Crush approximately 2 grams of sodium chloride (HI70406) and dry it for 2 hours at 140°C. Cool to room temperature in a desiccator.
- Weigh 0.20 g of dried sodium chloride with an accuracy of 0.0001 g. Transfer the salt to a 100 mL volumetric flask. Add approximately 80 mL of distilled water and mix. Dissolve completely before bringing to volume.

- Use a Class A volumetric pipette to transfer exactly 5.00 mL of prepared standard solution to a 150 mL glass beaker and add distilled water to the 100 mL mark on the beaker.
- Add 10.00 mL of 1.5M nitric acid (HI70427) to the beaker.

### ANALYSIS





- Place the beaker under the stirrer assembly and lower it to immerse the Silver/Sulfide electrode and stirrer. Ensure that the reference junction of the electrode is 5 to 6 mm below the surface. If necessary add extra deionized water.

**Note:** *The dispensing tip should be slightly submerged in the sample.*

- Press . You will be prompted to enter the weight of the analyte (weight of sodium chloride). Use the numeric keypad to enter the exact weight and press  to start the analysis.
- At the end of the titration, after detection of the equivalence point, "Titration Completed" will appear with the result. The result is expressed in **M (mol/L) of silver nitrate**.
- Remove the electrode and stirrer from the sample and rinse them thoroughly with deionized water.
- Record the result.

**Note:** *For improved accuracy, repeat this procedure a minimum of three times and calculate the average value.*

**For methods utilizing 0.02M silver nitrate titrant solution, follow the steps below to enter the titer/standardized value.**

- Select the method utilizing 0.02M silver nitrate.
- Press  from the main screen.
- Using the arrow keys, highlight Titrant Conc. and press .
- Use the numeric keypad to enter the standardized (titer) value of the titrant then press .
- Press  to exit the **View/Modify Method** screen. Use the arrow keys to highlight *Save Method* and press .

## METHOD PARAMETERS

Name: 0.02M Silver Nitrate  
 Method Revision: 3.0  
 Analysis Type: Standard Titration  
 Analog Board: Analog 1  
 Stirrer Configuration:  
   Stirrer: Stirrer 1  
   Stirring Speed: 1400 RPM  
 Pump Configuration:  
   Titrant Pump: Pump 1  
 Reagent Addition 1: Disabled  
 Reagent Addition 2: Disabled  
 Dosing Type: Dynamic  
   Min Vol: 0.030 mL  
   Max Vol: 0.500 mL  
   delta E: 8.000 mV  
 End Point Mode:mV 1EQ point, 1st Der  
 Recognition Options:  
   Threshold: 100 mV/mL  
   Range: NO  
   Filtered Derivatives: YES  
 Pre-Titration Volume: 6.000 mL  
 Pre-Titration Stir Time: 0 sec  
 Measurement Mode: Signal Stability  
   delta E: 1.0 mV  
   delta t: 2 sec  
   Min wait: 2 sec  
   Max wait: 20 sec  
 Electrode Type: Silver/Sulfide  
 Blank Option: No Blank  
 Calculations:Stdz. Titrant by Weight  
 Dilution Option: Enabled  
   Final Dilution Volume: 100.000 mL  
   Aliquot Volume: 5.000 mL  
 Titrant Name: 0.02M AgNO3  
 Analyte Size: 0.20000 g  
 Analyte Entry: Manual  
 Maximum Titrant Volume: 15.000 mL  
 Potential Range:-2000.0 to 2000.0 mV  
 Volume/Flow Rate: 25 mL/50.0 mL/min  
 Signal Averaging: 1 Reading  
 Significant Figures: XXXXX

## CALCULATIONS

Calculations:Stdz. Titrant by Weight  
 Titrant units: M (mol/L)  
 Titrant volume dosed: V (L)  
 Standard weight: 0.200 g  
 Dilution Factor: 0.05  
   Final Dilution volume: 100.000 mL  
   Aliquot Volume: 5.000 mL  
 mw of standard: 58.440 g/mol  
 Titrant/Standard: 1.000 mol/mol

$$\frac{\text{mol}}{\text{L}} \text{AgNO}_3 = \frac{0.200 * 0.05 * 1.0}{58.440 * V(L)}$$

## RESULTS

## Titration Report

Method Name: 0.02M Silver Nitrate  
 Time & Date: 15:52 August 1, 2018  
 Report ID: Ti\_00037

## Titration Results

Method Name: 0.02M Silver Nitrate  
 Time & Date: 15:52 August 1, 2018  
 Analyte Size: 0.1923 g  
 End Point Volume: 9.065 mL  
 mV Equivalence Point: 273.1  
 Result: 0.01815 M (mol/L)  
 Initial & Final mV: 146.9 to 291.0  
 Titration Duration: 2:21 [mm:ss]  
 Titration went to Completion

Analyst Signature: \_\_\_\_\_

## HI1004EN ALKALINITY OF WATER

### 0 to 2500 mg/L CaCO<sub>3</sub>, pH 4.5 Endpoint

#### DESCRIPTION

Method for the determination of total (methyl red) alkalinity in water by titration of a sample to pH 4.5. The results are expressed in **mg/L (ppm) as calcium carbonate**.

For the determination of phenolphthalein alkalinity, set the endpoint to pH 8.3.

#### REFERENCE

Standard Methods for the Examination of Water and Wastewater 21<sup>st</sup> edition, Method 2320B

#### ELECTRODE

- HI1131B Combination pH Electrode
- HI7662-T Temperature Probe

#### REAGENTS

- HI70463 0.1N Hydrochloric Acid (1 L)
- HI70436 Deionized Water (1 gal)

#### ACCESSORIES

- HI70300L Storage Solution (500 mL)
- HI7082 Electrode Fill Solution (4 x 30 mL)
- HI7004L pH 4.01 Buffer Solution (500 mL)
- HI7007L pH 7.01 Buffer Solution (500 mL)
- HI7010L pH 10.01 Buffer Solution (500 mL)
- HI740036P 100 mL Plastic Beaker (10 pcs)
- 50 mL Class A Volumetric Pipette

#### DEVICE PREPARATION

- Connect the pH electrode and temperature probe to the titrator.
- Install a 25 mL burette filled with 0.1N hydrochloric acid (HI70463) on pump one and verify that no air bubbles are present in the burette or tubing. If necessary prime the burette until all the air has been removed completely.
- For the determination of the exact concentration of the 0.1N hydrochloric acid, follow *HI0002EN 0.1N Hydrochloric Acid Titrant Concentration*.
- Press  from the main screen. Use the arrow keys to highlight *HI1004EN Alkalinity of Water* and press .

#### ELECTRODE PREPARATION

- Press  from the main screen, if necessary select the analog board and press .
- Calibrate the electrode using pH 4.01, 7.01 and 10.01 buffers. Refer to the instruction manual for calibration procedure.

#### SAMPLE PREPARATION

- Use a Class A volumetric pipette to transfer exactly 50.00 mL of sample to a clean 100 mL plastic beaker.

#### ANALYSIS

- Place the beaker under the stirrer assembly and lower it to immerse the pH electrode, temperature sensor and stirrer. Ensure that the reference junction of the pH electrode is 5 to 6 mm below the surface. If necessary add extra deionized water.

**Note:** *The dispensing tip should be slightly submerged in the sample.*

- Press . The titrator will start the analysis.
- At the end of the titration, when pH 4.50 is reached, "Titration Completed" will appear with the result. The result is expressed in **mg/L as calcium carbonate**.
- Remove the electrode and stirrer from the sample and rinse them thoroughly with deionized water.
- Record the result.

## METHOD PARAMETERS

Name: Alkalinity of Water  
 Method Revision: 3.0  
 Analysis Type: Standard Titration  
 Analog Board: Analog 1  
 Stirrer Configuration:  
   Stirrer: Stirrer 1  
   Stirring Speed: 1400 RPM  
 Pump Configuration:  
   Titrant Pump: Pump 1  
 Reagent Addition 1: Disabled  
 Reagent Addition 2: Disabled  
 Dosing Type: Dynamic  
   Min Vol: 0.050 mL  
   Max Vol: 0.500 mL  
   delta E: 5.000 mV  
 End Point Mode: Fixed 4.500 pH  
 Pre-Titration Volume: 0.000 mL  
 Pre-Titration Stir Time: 0 sec  
 Measurement Mode: Signal Stability  
   delta E: 1.0 mV  
   deltat: 2 sec  
   Min wait: 2 sec  
   Max wait: 20 sec  
 Electrode Type: pH  
 Blank Option: No Blank  
 Calculations: Sample Calc. by Volume  
 Dilution Option: Disabled  
 Titrant Name: 0.1N HCl  
 Titrant Conc.: 0.1000 N(eq/L)  
 Analyte Size: 50.000 mL  
 Analyte Entry: Fixed  
 Maximum Titrant Volume: 25.000 mL  
 Potential Range: -2000.0 to 2000.0 mV  
 Volume/Flow Rate: 25 mL/50.0 mL/min  
 Signal Averaging: 1 Reading  
 Significant Figures: XXXXX

## CALCULATIONS

Calculations: Sample Calc. by Volume  
 Titrant units: N (eq/L)  
 Titrant volume dosed: V (L)  
 Final result units: mg/L  
 Titrant Conc.: 0.1000 N(eq/L)  
 Sample/Titrant: 0.500 mol/eq  
 mw of standard: 100.09 g/mol  
 Sample Volume: 50.000 mL

$$\frac{\text{mg}}{\text{L}} \text{CaCO}_3 = \frac{V(\text{L}) * 1000 * 0.10 * 0.5 * 100.09 * 1000}{50.00}$$

## RESULTS

## Titration Report

Method Name: Alkalinity of Water  
 Time & Date: 14:36 August 1, 2018  
 Report ID: Ti\_00036

## Titration Results

Method Name: Alkalinity of Water  
 Time & Date: 14:36 August 1, 2018  
 Analyte Size: 50.000 mL  
 End Point Volume: 9.336 mL  
 pH Fixed End Point: 4.500  
 Result: 934.44 mg/L  
 Initial & Final pH: 10.232 to 4.419  
 Titration Duration: 3:23 [mm:ss]  
 Titration went to Completion

Analyst Signature: \_\_\_\_\_

## HI1005EN ACIDITY OF WATER

### 0 to 2500 mg/L, pH 8.3 Endpoint

#### DESCRIPTION

Method for the determination of total (phenolphthalein) acidity in water by titration of a sample to pH 8.3. The results are expressed in **mg/L (ppm) as calcium carbonate**.

For the determination of methyl orange acidity, set the endpoint to pH 3.7.

#### REFERENCE

Standard Methods for the Examination of Water and Wastewater 21<sup>st</sup> edition, Method 2310B

#### ELECTRODE

- HI1131B Combination pH Electrode
- HI7662-T Temperature Probe

#### REAGENTS

- HI70456 0.1N Sodium Hydroxide (1 L)
- HI70436 Deionized Water (1 gal)

#### ACCESSORIES

- HI70300L Storage Solution (500 mL)
- HI7082 Electrode Fill Solution (4 x 30 mL)
- HI7004L pH 4.01 Buffer Solution (500 mL)
- HI7007L pH 7.01 Buffer Solution (500 mL)
- HI7010L pH 10.01 Buffer Solution (500 mL)
- HI740036P 100 mL Plastic Beaker (10 pcs)
- 50 mL Class A Volumetric Pipette

#### DEVICE PREPARATION

- Connect the pH electrode and temperature probe to the titrator.
- Install a 25 mL burette filled with 0.1N sodium hydroxide (HI70456) on pump one and verify that no air bubbles are present in the burette or tubing. If necessary prime the burette until all the air has been removed completely.
- For the determination of the exact concentration of the 0.1N sodium hydroxide, follow *HI0001EN 0.1N Sodium Hydroxide* Titrant Concentration.
- Press **Select Method** from the main screen. Use the arrow keys to highlight *HI1005EN Acidity in Water* and press **Select**.

#### ELECTRODE PREPARATION

- Press **Mode** from the main screen, if necessary select the analog board and press **pH**.
- Calibrate the electrode using pH 4.01, 7.01 and 10.01 buffers. Refer to the instruction manual for calibration procedure.

#### SAMPLE PREPARATION

- Use a Class A volumetric pipette to transfer exactly 50.00 mL of sample to a clean 100 mL plastic beaker.

#### ANALYSIS

- Place the beaker under the stirrer assembly and lower it to immerse the pH electrode, temperature sensor and stirrer. Ensure that the reference junction of the pH electrode is 5 to 6 mm below the surface. If necessary add extra deionized water.

**Note:** *The dispensing tip should be slightly submerged in the sample.*

- Press **start stop**, the titrator will start the analysis.
- At the end of the titration, when pH 8.30 is reached, "Titration Completed" will appear with the result. The result is expressed in **mg/L as calcium carbonate**.
- Remove the pH electrode, temperature probe and stirrer from the sample and rinse them thoroughly with deionized water.
- Record the result.

## METHOD PARAMETERS

Name: Acidity of Water  
 Method Revision: 3.0  
 Analysis Type: Standard Titration  
 Analog Board: Analog 1  
 Stirrer Configuration:  
   Stirrer: Stirrer 1  
   Stirring Speed: 1400 RPM  
 Pump Configuration:  
   Titrant Pump: Pump 1  
 Reagent Addition 1: Disabled  
 Reagent Addition 2: Disabled  
 Dosing Type: Dynamic  
   Min Vol: 0.050 mL  
   Max Vol: 0.500 mL  
   delta E: 5.000 mV  
 End Point Mode: Fixed 8.300 pH  
 Pre-Titration Volume: 0.000 mL  
 Pre-Titration Stir Time: 0 sec  
 Measurement Mode: Signal Stability  
   delta E: 1.0 mV  
   delta t: 2 sec  
   Min wait: 2 sec  
   Max wait: 20 sec  
 Electrode Type: pH  
 Blank Option: No Blank  
 Calculations: Sample Calc. by Volume  
 Dilution Option: Disabled  
 Titrant Name: 0.1N NaOH  
 Titrant Conc.: 0.1000 N(eq/L)  
 Analyte Size: 50.000 mL  
 Analyte Entry: Fixed  
 Maximum Titrant Volume: 25.000 mL  
 Potential Range: -2000.0 to 2000.0 mV  
 Volume/Flow Rate: 25 mL/50.0 mL/min  
 Signal Averaging: 1 Reading  
 Significant Figures: XXXXX

## CALCULATIONS

Calculations: Sample Calc. by Volume  
 Titrant units: N (eq/L)  
 Titrant volume dosed: V (L)  
 Final result units: (mg/L)  
 Titrant Conc.: 0.1000 N(eq/L)  
 Sample/Titrant: 0.500 mol/eq  
 mw of standard: 100.09 g/mol  
 Sample Volume: 50.000 mL

$$\frac{\text{mg}}{\text{L}} \text{CaCO}_3 = \frac{V(\text{L}) * 1000 * 0.10 * 0.5 * 100.09 * 1000}{50.0}$$

## RESULTS

## Titration Report

Method Name: Acidity of Water  
 Time & Date: 14:54 August 1, 2018  
 Report ID: Ti\_00023

## Titration Results

Method Name: Acidity of Water  
 Time & Date: 14:54 August 1, 2018  
 Analyte Size: 50.000 mL  
 End Point Volume: 5.879 mL  
 pH Fixed End Point: 8.300  
 Result: 588.43 (mg/L)  
 Initial & Final pH: 2.465 to 8.398  
 Titration Duration: 3:42 [mm:ss]  
 Titration went to Completion

Analyst Signature: \_\_\_\_\_

## HI1007EN CHLORIDE IN WATER

### 0 to 150 ppm (mg/L)

#### DESCRIPTION

Method for the determination of chloride in water. The results are expressed as **ppm (mg/L) as Chloride**.

#### REFERENCE

Standard Methods for the Examination of Water and Wastewater 21<sup>st</sup> edition, Method 4500-Cl

#### ELECTRODE

- HI4115 Silver/Sulfide Combination ISE



#### REAGENTS

- HI70448 0.02M Silver Nitrate (1 L)
- HI70427 1.5M Nitric Acid Solution (500 mL)
- HI70436 Deionized Water (1 gal)

#### ACCESSORIES

- HI7072 Electrode Fill Solution (4 x 30 mL)
- 150 mL Glass Beaker
- 100 mL Class A Volumetric Pipette
- 10 mL Class A Volumetric Pipette

#### DEVICE PREPARATION

- Connect the Silver/Sulfide electrode to the titrator.
- Install a 25 mL burette filled with 0.02M silver nitrate (HI70448) on pump one and verify that no air bubbles are present in the burette or tubing. If necessary prime the burette until all the air has been removed completely.
- For the determination of the exact concentration of the 0.02M Silver Nitrate, follow *HI0200EN 0.02M Silver Nitrate* Titrant Concentration.
- Press  from the main screen. Use the arrow keys to highlight *HI1007EN Chloride in Water* and press .

#### ELECTRODE PREPARATION

- Prepare the Silver/Sulfide electrode according to the procedure in the manual.

#### SAMPLE PREPARATION

- Use a class A volumetric pipette to transfer exactly 100.00 mL of sample to a clean 150 mL beaker.
- Add 10.00 mL of 1.5M nitric acid (HI70427) to the beaker.

#### ANALYSIS

- Place the beaker under the stirrer assembly and lower it to immerse the electrode and stirrer. Ensure that the reference junction of the electrode is 5 to 6 mm below the surface. If necessary add extra deionized water.

**Note:** *The dispensing tip should be slightly submerged in the sample.*

- Press , the titrator will start the analysis.
- At the end of the titration, after detection of the equivalence point, "Titration Completed" will appear with the result. The result is expressed in **ppm (mg/L) of chloride**.
- Remove the electrode and stirrer from the sample and rinse them thoroughly with deionized water.
- Record the result.



## METHOD PARAMETERS

Name: Chloride in Water  
 Method Revision: 3.0  
 Analysis Type: Standard Titration  
 Analog Board: Analog 1  
 Stirrer Configuration:  
   Stirrer: Stirrer 1  
   Stirring Speed: 1400 RPM  
 Pump Configuration:  
   Titrant Pump: Pump 1  
 Reagent Addition 1: Disabled  
 Reagent Addition 2: Disabled  
 Dosing Type: Dynamic  
   Min Vol: 0.030 mL  
   Max Vol: 0.500 mL  
   delta E: 5.000 mV  
 End Point Mode: mv 1EQ point, 1st Der  
 Recognition Options:  
   Threshold: 100 mV/mL  
   Range: NO  
   Filtered Derivatives: NO  
 Pre-Titration Volume: 0.000 mL  
 Pre-Titration Stir Time: 0 sec  
 Measurement Mode: Signal Stability  
   delta E: 1.0 mV  
   delta t: 2 sec  
   Min wait: 2 sec  
   Max wait: 20 sec  
 Electrode Type: Silver/Sulfide  
 Blank Option: No Blank  
 Calculations: Sample Calc. by Volume  
 Dilution Option: Disabled  
 Titrant Name: 0.02M AgNO3  
 Titrant Conc.: 2.0000E-2 M (mol/L)  
 Analyte Size: 100.000 mL  
 Analyte Entry: Manual  
 Maximum Titrant Volume: 25.000 mL  
 Potential Range: -2000.0 to 2000.0 mV  
 Volume/Flow Rate: 25 mL/50.0 mL/min  
 Signal Averaging: 1 Reading  
 Significant Figures: XXXXX

## CALCULATIONS

Calculations: Sample Calc. by Volume  
 Titrant units: M (mol/L)  
 Titrant volume dosed: V (L)  
 Final result units: (mg/L)  
 Titrant Conc.: 2.0000E-2 M (mol/L)  
 Sample/Titrant: 1.000 mol/mol  
 mw of sample: 35.453 g/mol  
 Sample Volume: 100.000 mL

$$\frac{\text{mg}}{\text{L}} = \frac{\text{V(L)} * 1000 * 0.02 * 1.0 * 35.45 * 1000}{100.0}$$

## RESULTS

## Titration Report

Method Name: Chloride in Water  
 Time & Date: 15:11 August 1, 2018  
 Report ID: Ti\_00052

## Titration Results

Method Name: Chloride in Water  
 Time & Date: 15:11 August 1, 2018  
 Analyte Size: 100.000 mL  
 End Point Volume: 4.781 mL  
 mV Fixed End Point: 280.3  
 Result: 33.897 ppm (mg/L)  
 Initial & Final mV: 94.8 to 298.5  
 Titration Duration: 1:24 [mm:ss]  
 Titration went to Completion

Analyst Signature: \_\_\_\_\_

## HI1008EN NEUTRALIZATION WITH SULFURIC ACID 0 to 200 meq/L

### DESCRIPTION

Method for the determination of strong or weak base concentration by titration of a sample to the equivalence point with sulfuric acid. The results are expressed as **meq/L**.

### ELECTRODE

- HI1131B Combination pH Electrode
- HI7662-T Temperature Probe



### REAGENTS

- HI70459 0.05M Sulfuric Acid (1 L)
- HI70436 Deionized Water (1 gal)



### ACCESSORIES

- HI70300L Storage Solution (500 mL)
- HI7082 Electrode Fill Solution (4 x 30 mL)
- HI7004L pH 4.01 Buffer Solution
- HI7007L pH 7.01 Buffer Solution
- HI7010L pH 10.01 Buffer Solution
- HI740036P 100 mL Plastic Beaker (10 pcs)
- 10 mL Class A Volumetric Pipette

### DEVICE PREPARATION

- Connect the pH electrode and temperature probe to the titrator.
- Install a 25 mL burette filled with 0.05M sulfuric acid (HI70459) on pump one and verify that no air bubbles are present in the burette or tubing. If necessary prime the burette until all the air has been removed completely.
- For the determination of the exact concentration of the 0.05M sulfuric acid, follow *HI10703EN 0.05M Sulfuric Acid* Titrant Concentration.
- Press  from the main screen. Use the arrow keys to highlight *HI1008EN Neutralization w/H2SO4* and press .

### ELECTRODE PREPARATION

- Press  from the main screen, if necessary select the analog board and press .
- Calibrate the electrode using pH 4.01, 7.01 and 10.01 buffers. Refer to the instruction manual for calibration procedure.

### SAMPLE PREPARATION

- Use a class A volumetric pipette to transfer exactly 10.00 mL of sample to a clean 100 mL plastic beaker.
- Add deionized water to the 50 mL mark on the beaker.

### ANALYSIS

- Place the beaker under the stirrer assembly and lower it to immerse the pH electrode, temperature probe and stirrer. Ensure that the reference junction of the pH electrode is 5 to 6 mm below the surface.

**Note:** *The dispensing tip should be slightly submerged in the sample.*

- Press , the titrator will start the analysis.
- At the end of the titration, after detection of the equivalence point, "Titration Completed" will appear with the result. The result is expressed in **meq/L**.
- Remove the pH electrode and stirrer from the sample and rinse them thoroughly with deionized water.
- Record the result.

## METHOD PARAMETERS

Name: Neutralization w/ H2SO4  
 Method Revision: 3.0  
 Analysis Type: Standard Titration  
 Analog Board: Analog 1  
 Stirrer Configuration:  
   Stirrer: Stirrer 1  
   Stirring Speed: 1400 RPM  
 Pump Configuration:  
   Titrant Pump: Pump 1  
 Reagent Addition 1: Disabled  
 Reagent Addition 2: Disabled  
 Dosing Type: Dynamic  
   Min Vol: 0.050 mL  
   Max Vol: 0.500 mL  
   delta E: 20.000 mV  
 End Point Mode:pH 1EQ point, 1st Der  
 Recognition Options:  
   Threshold: 50 mV/mL  
   Range: NO  
   Filtered Derivatives: NO  
 Pre-Titration Volume: 0.000 mL  
 Pre-Titration Stir Time: 0 sec  
 Measurement Mode: Signal Stability  
   delta E: 1.0 mV  
   delta t: 2 sec  
   Min wait: 2 sec  
   Max wait: 15 sec  
 Electrode Type: pH  
 Blank Option: No Blank  
 Calculations: Sample Calc. by Volume  
 Dilution Option: Disabled  
 Titrant Name: 0.05M H2SO4  
 Titrant Conc.: 5.0000E-2 M (mol/L)  
 Analyte Size: 10.000 mL  
 Analyte Entry: Fixed  
 Maximum Titrant Volume: 20.000 mL  
 Potential Range:-2000.0 to 2000.0 mV  
 Volume/Flow Rate: 25 mL/50.0 mL/min  
 Signal Averaging: 1 Reading  
 Significant Figures: XXXXX

## CALCULATIONS

Calculations: Sample Calc. by Volume  
 Titrant units: M (mol/L)  
 Titrant volume dosed: V (L)  
 Final result units: meq/L  
 Titrant Conc.: 5.0000E-2 M (mol/L)  
 Sample/Titrant: 2.000 eq/mol  
 Sample Volume: 10.000 mL

$$\frac{\text{meq}}{\text{L}} = \frac{\text{V(L)} * 1000 * 0.05 * 2.0 * 1000}{10.0}$$

## RESULTS

## Titration Report

Method Name: Neutralization w/ H2SO4  
 Time & Date: 09:46 August 1, 2018  
 Report ID: Ti\_00027

## Titration Results

Method Name: Neutralization w/ H2SO4  
 Time & Date: 09:46 August 1, 2018  
 Analyte Size: 10.000 mL  
 End Point Volume: 9.562 mL  
 mV Equivalence Point: 7.966  
 Result: 95.620 meq/L  
 Initial & Final pH: 11.655 to 6.248  
 Titration Duration: 1:24 [mm:ss]  
 Titration went to Completion

Analyst Signature: \_\_\_\_\_

## HI1009EN NEUTRALIZATION WITH SODIUM HYDROXIDE 0 to 200 meq/L

### DESCRIPTION

Method for the determination of strong or weak acid concentration by titration of a sample to the equivalence point with sodium hydroxide. The results are expressed as meq/L.

### ELECTRODE

- HI1131B Combination pH Electrode
- HI7662-T Temperature Probe

### REAGENTS

- HI70456 0.1N Sodium Hydroxide (1 L)
- HI70436 Deionized Water (1 gal)

### ACCESSORIES

- HI70300L Storage Solution (500 mL)
- HI7082 Electrode Fill Solution (4 x 30 mL)
- HI7004L pH 4.01 Buffer Solution
- HI7007L pH 7.01 Buffer Solution
- HI7010L pH 10.01 Buffer Solution
- HI740036P 100 mL Plastic Beaker (10 pcs)
- 10 mL Class A Volumetric Pipette

### DEVICE PREPARATION

- Connect the pH electrode and temperature probe to the titrator.
- Install a 25 mL burette filled with 0.1N sodium hydroxide (HI70456) on pump one and verify that no air bubbles are present in the burette or tubing. If necessary prime the burette until all the air has been removed completely.
- For the determination of the exact concentration of the 0.1N sodium hydroxide, follow *HI0001EN 0.1N Sodium Hydroxide Titrant Concentration*
- Press Select Method from the main screen. Use the arrow keys to highlight *HI1009EN Neutralization w/NaOH* and press Select.

### ELECTRODE PREPARATION

- Press Mode from the main screen, if necessary select the analog board and press pH.
- Calibrate the electrode using pH 4.01, 7.01 and 10.01 buffers. Refer to the instruction manual for calibration procedure.

### SAMPLE PREPARATION

- Use a class A volumetric pipette to transfer exactly 10.00 mL of sample to a clean 100 mL plastic beaker.
- Add deionized water to the 50 mL mark on the beaker.

### ANALYSIS

- Place the beaker under the stirrer assembly and lower it to immerse the pH electrode, temperature probe and stirrer. Ensure that the reference junction of the pH electrode is 5 to 6 mm below the surface.

**Note:** The dispensing tip should be slightly submerged in the sample.

- Press start stop, the titrator will start the analysis.
- At the end of the titration, after detection of the equivalence point, "Titration Completed" will appear with the result. The result is expressed in meq/L.
- Remove the pH electrode and stirrer from the sample and rinse them thoroughly with deionized water.
- Record the result.

## METHOD PARAMETERS

Name: Neutralization w/ NaOH  
 Method Revision: 3.0  
 Analysis Type: Standard Titration  
 Analog Board: Analog 1  
 Stirrer Configuration:  
   Stirrer: Stirrer 1  
   Stirring Speed: 1400 RPM  
 Pump Configuration:  
   Titrant Pump: Pump 1  
 Reagent Addition 1: Disabled  
 Reagent Addition 2: Disabled  
 Dosing Type: Dynamic  
   Min Vol: 0.050 mL  
   Max Vol: 0.500 mL  
   delta E: 20.000 mV  
 End Point Mode:pH 1EQ point, 1st Der  
 Recognition Options:  
   Threshold: 50 mV/mL  
   Range: NO  
   Filtered Derivatives: NO  
 Pre-Titration Volume: 0.000 mL  
 Pre-Titration Stir Time: 0 sec  
 Measurement Mode: Signal Stability  
   delta E: 1.0 mV  
   delta t: 2 sec  
   Min wait: 2 sec  
   Max wait: 15 sec  
 Electrode Type: pH  
 Blank Option: No Blank  
 Calculations: Sample Calc. by Volume  
 Dilution Option: Disabled  
 Titrant Name: 0.1N NaOH  
 Titrant Conc.: 0.1000 N(eq/L)  
 Analyte Size: 10.000 mL  
 Analyte Entry: Fixed  
 Maximum Titrant Volume: 20.000 mL  
 Potential Range:-2000.0 to 2000.0 mV  
 Volume/Flow Rate: 25 mL/50.0 mL/min  
 Signal Averaging: 1 Reading  
 Significant Figures: XXXXX

## CALCULATIONS

Calculations: Sample Calc. by Volume  
 Titrant units: N (eq/L)  
 Titrant volume dosed: V (L)  
 Final result units: meq/L  
 Titrant Conc.: 5.0000E-2 M (mol/L)  
 Sample/Titrant: 0.1000 N(eq/L)  
 Sample Volume: 10.000 mL

$$\frac{\text{meq}}{\text{L}} = \frac{V(\text{L}) * 1000 * 0.1 * 1.0 * 1000}{10.0}$$

## RESULTS

## Titration Report

Method Name: Neutralization w/ NaOH  
 Time & Date: 10:29 August 2, 2018  
 Report ID: Ti\_00017

## Titration Results

Method Name: Neutralization w/ NaOH  
 Time & Date: 10:29 August 2, 2018  
 Analyte Size: 10.000 mL  
 End Point Volume: 15.970 mL  
 pH Equivalence Point: 8.431  
 Result: 159.70 meq/L  
 Initial & Final pH: 2.675 to 10.316  
 Titration Duration: 3:20 [mm:ss]  
 Titration went to Completion

Analyst Signature: \_\_\_\_\_

## HI1011EN TROUBLESHOOTING 1

## DESCRIPTION

Method for verifying the dosing and potentiometric signal accuracy of the titrator. This method should be used to troubleshoot a titrator equipped with a 25 mL burette. The titrator dispenses a 20.00 mL pre-titration volume, waits 20 seconds and dispenses an additional 20.00 mL dose, bringing the total volume to 40.00 mL. This procedure can also be used to check the stability of the mV and temperature channels.

The dosing accuracy of the 25 mL burette is  $\pm 0.025$  mL ( $\pm 0.1\%$  of the full volume).

If the results are not correct, check all fittings for leakage, and burette and tubing for air bubbles. Repeat the measurement.



## REFERENCE

ISO/TC 48/SC1N 380E and 383E: "Piston and/or Plunger Operated Volumetric Apparatus"

## ACCESSORIES

- HI762000C 0°C Temperature Key
- HI762070C 70°C Temperature Key
- HI70436 Deionized Water (1 gal)
- HI7662-T Temperature Probe
- Shorting Cap
- Narrow Neck Beaker
- Analytical Balance with 0.0001g resolution

## DEVICE PREPARATION

- Connect the shorting cap to the BNC socket on Analog Board 1
- Install a 25 mL burette filled with room temperature deionized water (HI70436) on pump one and verify that no air bubbles are present in the burette or tubing. If necessary prime the burette until all the air has been removed completely.
- Press  from the main screen. Use the arrow keys to highlight *HI1011EN Troubleshooting 1* and press .

## LARGE DOSE DISPENSING PROCEDURE

- Add a small amount of deionized water to a narrow neck beaker.

- Place the narrow neck beaker on an analytical balance and zero the balance.
- Place the dosing tip through the neck of the beaker. Take care not to immerse it in the liquid during dispensing and not to touch the beaker walls.
- Press .
- Write down the exact weight displaced on the balance after each dose.
- This procedure can be repeated on pump 2.

Other burette sizes can be checked using the following settings, see instruction manual for accuracy:

Burette Volume	Pre-titration Volume	Max. Titrant Volume
5 mL	4.000 mL	8.000 mL
10 mL	8.000 mL	16.000 mL

## METHOD PARAMETERS

Name: Troubleshooting 1  
 Method Revision: 3.0  
 Analysis Type: Standard Titration  
 Analog Board: Analog 1  
 Stirrer Configuration:  
   Stirrer: Stirrer 1  
   Stirring Speed: 0 RPM  
 Pump Configuration:  
   Titrant Pump: Pump 1  
 Reagent Addition 1: Disabled  
 Reagent Addition 2: Disabled  
 Dosing Type: Linear - 20.000 mL  
 End Point Mode: Fixed 10.0 mV  
 Pre-Titration Volume: 20.000 mL  
 Pre-Titration Stir Time: 0 sec  
 Measurement Mode: Timed Increment  
   Time interval: 20 sec  
 Electrode Type: Shorting Cap  
 Blank Option: No Blank  
 Calculations: No Formula (mL only)  
 Titrant Name: DI Water  
 Maximum Titrant Volume: 40.000 mL  
 Potential Range: -2000.0 to 2000.0 mV  
 Volume/Flow Rate: 25 mL/50.0 mL/min  
 Signal Averaging: 1 Reading  
 Significant Figures: XXXXX

## CALCULATIONS

$$V = m * \frac{1}{\rho} * \left( 1 + \frac{\rho_{\text{air}}}{\rho_L} - \frac{\rho_{\text{air}}}{\rho_{\text{std}}} \right)$$

- V Volume of measure mass of water (mL)  
 m Measure mass of water (g)  
 $\rho_L$  Density of dispensed water (g/mL)  
 $\rho_{\text{air}}$  Density of ambient air (g/mL)  
 $\rho_{\text{std}}$  Density of calibration standard weight (g/mL)

## ALTERNATIVE CALCULATIONS

If the actual values of the above parameters are not accessible the following equation can be used:

$$V = M * F$$

- V Volume of measured mass of water (mL)  
 F Transformation factor

The values from the table have been calculated by correcting the air and water density with temperature, assuming the density of dry air  $\rho_{\text{air}} = 0.0012$  g/mL and density of calibration steel standard weigh  $\rho_{\text{STD}} = 8$  g/mL.

Temperature ( °C)	Factor
17.0	1.002290
18.0	1.002467
19.0	1.002654
20.0	1.002853
21.0	1.003061
22.0	1.003282
23.0	1.003512
24.0	1.003752
25.0	1.004002
26.0	1.004261
27.0	1.004531
28.0	1.004809
29.0	1.005097
30.0	1.005395

## TEMPERATURE CHANNEL FAST CHECK PROCEDURE

- Connect the shorting cap to the BNC socket on Analog Board 1.
- Connect the HI762000C 0°C temperature key to the RCA socket (temperature sensor input) on Analog Board 1.

- On the main screen select **Mode** if necessary select the analog board and press **mV**.
- The titrator should display ATC 0.0 ± 0.4°C with no fluctuations or drift.
- Connect the HI762070C 70°C temperature key to the RCA socket (temperature sensor input) on Analog Board 1.
- The titrator should display ATC 70.0 ± 0.4°C with no fluctuations or drift.
- This procedure can be repeated on analog board 2.

## TEMPERATURE & mV CHANNEL LOGGING PROCEDURE

- Connect the shorting cap to the BNC socket on Analog Board 1.
- Connect the HI762000C 0°C temperature key to the RCA socket (temperature sensor input) on Analog Board 1.
- On the main screen select **Mode** if necessary select the analog board and press **mV**.
- Press **mV Setup** and use the arrow keys to highlight Logging Interval. Set the logging interval to 15 seconds and press **Accept**. Press **Escape** to return to the main screen.
- Press the **results** key and use the arrow keys to highlight Setup pH/mV/ISE Report, press **Select**.
- Select Potential and Temperature and Units. All other fields should be unselected.
- Press **Save Report** to return to the Data Parameters screen.
- Press **Escape** to return to the main screen.
- Once on the main screen press **Start Log** to start the automatic log.
- Let the log run for about 10 minutes. Press **Stop Log** to stop the automatic log.
- Press **results**, use the arrow keys to highlight Review Last Analysis Report, and press **Select**.
- The mV column should display 0.0 ± 0.1 mV and the temperature column should display 0.0°C ± 0.4°C.
- This procedure can be repeated using the HI762070C 70°C temperature key and on analog board 2.

## HI1012EN TROUBLESHOOTING 2

## DESCRIPTION

Method for verifying the dosing of the titrator. This method should be used to troubleshoot a titrator equipped with a 25 mL burette. The titrator dispenses a 10.00 mL pre-titration volume, waits 20 seconds and dispenses an additional 0.5 mL dose twenty times, waiting 20 seconds between each dose, bringing the total volume to 20 mL. This procedure can also be used to check the stirrer functionality.

The dosing accuracy of the 25 mL burette is  $\pm 0.025$  mL ( $\pm 0.1\%$  of the full volume).

If the results are not correct, check all fittings for leakage, and burette and tubing for air bubbles. Repeat the measurement.



## REFERENCE

ISO/TC 48/SC1N 380E and 383E: "Piston and/or Plunger Operated Volumetric Apparatus"

## ACCESSORIES

- HI762000C 0°C Temperature Key
- HI70436 Deionized Water (1 gal)
- HI7662-T Temperature Probe
- Shorting Cap
- Narrow Neck Beaker
- Analytical Balance with 0.0001g resolution

## DEVICE PREPARATION

- Connect the shorting cap to the BNC socket on Analog Board 1
- Install a 25 mL burette filled with room temperature deionized water (HI70436) on pump one and verify that no air bubbles are present in the burette or tubing. If necessary prime the burette until all the air has been removed completely.
- Press  from the main screen. Use the arrow keys to highlight *HI1012EN Troubleshooting 2* and press .

## SMALL DOSE DISPENSING PROCEDURE

- Add a small amount of deionized water to a narrow neck beaker. By doing this the air space in the beaker will be vapor-saturated minimizing evaporation.
- Place the narrow neck beaker on an analytical balance and zero the balance.
- Place the dosing tip through the neck of the beaker. Take care not to immerse it in the liquid during dispensing and not to touch the beaker walls.
- Press .
- Write down the exact weight displaced on the balance after each dose.
- This procedure can be repeated on pump 2.

Other burette sizes can be checked using the following settings, see instruction manual for accuracy:

Burette Volume	Pre-titration Volume	Max. Titrant Volume
5 mL	4.000 mL	8.000 mL
10 mL	8.000 mL	16.000 mL



## METHOD PARAMETERS

Name: Troubleshooting 2  
 Method Revision: 3.0  
 Analysis Type: Standard Titration  
 Analog Board: Analog 1  
 Stirrer Configuration:  
   Stirrer: Stirrer 1  
   Stirring Speed: 0 RPM  
 Pump Configuration:  
   Titrant Pump: Pump 1  
 Reagent Addition 1: Disabled  
 Reagent Addition 2: Disabled  
 Dosing Type: Linear - 0.500 mL  
 End Point Mode: Fixed 10.0 mV  
 Pre-Titration Volume: 10.000 mL  
 Pre-Titration Stir Time: 0 sec  
 Measurement Mode: Timed Increment  
   Time interval: 10 sec  
 Electrode Type: Shorting Cap  
 Blank Option: No Blank  
 Calculations: No Formula (mL only)  
 Titrant Name: DI Water  
 Maximum Titrant Volume: 20.000 mL  
 Potential Range: -2000.0 to 2000.0 mV  
 Volume/Flow Rate: 25 mL/50.0 mL/min  
 Signal Averaging: 1 Reading  
 Significant Figures: XXXXX

## CALCULATIONS

$$V = m * \frac{1}{\rho} * \left( 1 + \frac{\rho_{\text{air}}}{\rho_L} - \frac{\rho_{\text{air}}}{\rho_{\text{std}}} \right)$$

- V Volume of measure mass of water (mL)
- m Measure mass of water (g)
- $\rho_L$  Density of dispensed water (g/mL)
- $\rho_{\text{air}}$  Density of ambient air (g/mL)
- $\rho_{\text{std}}$  Density of calibration standard weight (g/mL)

## ALTERNATIVE CALCULATIONS

If the actual values of the above parameters are not accessible the following equation can be used:

$$V = M * F$$

- V Volume of measured mass of water (mL)
- F Transformation factor

The values from the table have been calculated by correcting the air and water density with temperature, assuming the density of dry air  $\rho_{\text{air}} = 0.0012$  g/mL and density of calibration steel standard weigh  $\rho_{\text{STD}} = 8$  g/mL.

Temperature (°C)	Factor
17.0	1.002290
18.0	1.002467
19.0	1.002654
20.0	1.002853
21.0	1.003061
22.0	1.003282
23.0	1.003512
24.0	1.003752
25.0	1.004002
26.0	1.004261
27.0	1.004531
28.0	1.004809
29.0	1.005097
30.0	1.005395

## STIRRING SPEED FAST CHECK PROCEDURE

- On the main screen select **Mode** if necessary select the analog board and press **mV**.
- Press **mV Setup** and use the arrow keys to highlight Stirrer Configuration. Use the arrow keys to highlight Stirrer 1. Press **Accept**.
- Use the arrow keys to highlight String Speed. Use the numeric keypad to enter 200 rpms then press **Accept**.
- Press **Escape** to exit the mV Setup screen.
- From the main screen, press **stir**, use the up arrow key to increase the stir speed slowly to 2500 rpms.
- Check that the propeller continues to increase speed, following the commands.
- This procedure can be repeated on stirrer 2.

## HI1014EN CONCENTRATION OF PHOSPHORIC ACID 0.00 to 0.01 M (mol/L)

### DESCRIPTION

Method for the determination of phosphoric acid ( $H_3PO_4$ ), by titration of a sample to the point of inflection with sodium hydroxide.

The first inflection point corresponds to the  $H_3PO_4$  content and the difference between the first and second corresponds to  $H_2PO_4^-$ . The results are expressed as **M (mol/L) phosphoric acid**.

If only phosphoric acid and no other acids or bases are present in the sample, then  $H_3PO_4 = H_2PO_4^-$ . If  $H_3PO_4$  is greater than  $H_2PO_4^-$  this means other weak acids or bases are present (e.g. citric acid / citrate or ascorbic acid / ascorbate).

### ELECTRODE

- HI1131B Combination pH Electrode
- HI7662-T Temperature Probe

### REAGENTS



- HI70456 0.1N Sodium Hydroxide (1 L)
- HI70436 Deionized Water (1 gal)

### ACCESSORIES



- HI70300L Storage Solution (500 mL)
- HI7082 Electrode Fill Solution (4 x 30 mL)
- HI7004L pH 4.01 Buffer Solution (500 mL)
- HI7007L pH 7.01 Buffer Solution (500 mL)
- HI7010L pH 10.01 Buffer Solution (500 mL)
- 100 mL Class A Volumetric Pipette
- 150 mL Glass Beaker

### DEVICE PREPARATION

- Connect the pH electrode and temperature probe to the titrator.
- Install a 25 mL burette filled with 0.1N sodium hydroxide (HI70456) on pump one and verify that no air bubbles are present in the burette or tubing. If necessary prime the burette until all the air has been removed completely.
- For the determination of the exact concentration of the 0.1 N sodium hydroxide, follow *HI0001EN 0.1N Sodium Hydroxide* Titrant Concentration.

- Press  from the main screen. Use the arrow keys to highlight *HI1014EN Concentration of H3PO4* and press .

### ELECTRODE PREPARATION

- Press  from the main screen, if necessary select the analog board and press .
- Calibrate the electrode using pH 4.01, 7.01 and 10.01 buffers. Refer to the instruction manual for calibration procedure.

### SAMPLE PREPARATION

- Use a Class A volumetric pipette to transfer exactly 100.00 mL of sample to a clean 150 mL glass beaker.

### ANALYSIS

- Place the beaker under the stirrer assembly and lower it to immerse the pH electrode, temperature probe and stirrer. Ensure that the reference junction of the pH electrode is 5 to 6 mm below the surface.

**Note:** *The dispensing tip should be slightly submerged in the sample.*

- Press , the titrator will start the analysis.
- At the end of the titration, after detection of the equivalence point, "Titration Completed" will appear with the result. The result is expressed in **M (mol/L) of phosphoric acid**.
- Remove the pH electrode and stirrer from the sample and rinse them thoroughly with deionized water.
- Record the result.

## METHOD PARAMETERS

Name: Concentration of H3PO4  
 Method Revision: 3.0  
 Analysis Type: Standard Titration  
 Analog Board: Analog 1  
 Stirrer Configuration:  
   Stirrer: Stirrer 1  
   Stirring Speed: 1400 RPM  
 Pump Configuration:  
   Titrant Pump: Pump 1  
 Reagent Addition 1: Disabled  
 Reagent Addition 2: Disabled  
 Dosing Type: Dynamic  
   Min Vol: 0.030 mL  
   Max Vol: 0.500 mL  
   delta E: 8.000 mV  
 End Point Mode: pH 2EQ points, 1st Der  
 Recognition Options:  
   Threshold: 50 mV/mL  
   Range: NO  
   Filtered Derivatives: NO  
 Pre-Titration Volume: 0.000 mL  
 Pre-Titration Stir Time: 10 sec  
 Measurement Mode: Signal Stability  
   delta E: 0.8 mV  
   delta t: 2 sec  
   Min wait: 2 sec  
   Max wait: 20 sec  
 Electrode Type: pH  
 Blank Option: No Blank  
 Calculations: Sample Calc. by Volume  
 Dilution Option: Disabled  
 Titrant Name: 0.1N NaOH  
 Titrant Conc.: 0.1000 N(eq/L)  
 Analyte Size: 100.000 mL  
 Analyte Entry: Fixed  
 Maximum Titrant Volume: 20.000 mL  
 Potential Range: -2000.0 to 2000.0 mV  
 Volume/Flow Rate: 25 mL/50.0 mL/min  
 Signal Averaging: 1 Reading  
 Significant Figures: XXXXX

## CALCULATIONS

Calculations: Sample Calc. by Volume  
 Titrant units: N (eq/L)  
 Titrant volume dosed: V (L)  
 Final result units: M (mol/L)  
 Titrant Conc.: 0.1000 N(eq/L)  
 Sample/Titrant: 1.000 mol/eq  
 Sample Volume: 100.000 mL

$$\frac{\text{mol}}{\text{L}} = \frac{V(\text{L}) * 100 * 0.1 * 1.0}{100.00}$$

## RESULTS

## Titration Report

Method Name: Concentration of H3PO4  
 Time & Date: 11:56 August 2, 2018  
 Report ID: Ti\_00034

## Titration Results

Method Name: Concentration of H3PO4  
 Time & Date: 11:56 August 2, 2018  
 Analyte Size: 100.000 mL  
 Equivalence point 1:  
   pH: 4.677  
   Volume: 4.397 mL  
   Result: 4.3972E-03 M (mol/L)  
 Equivalence point 2:  
   pH: 8.916  
   Volume: 4.429 mL  
   Result: 4.4293E-03 M (mol/L)  
 Titration Duration: 1:24 [mm:ss]  
 Titration went to Completion

Analyst Signature: \_\_\_\_\_



## PART 4:

## TITRATION THEORY

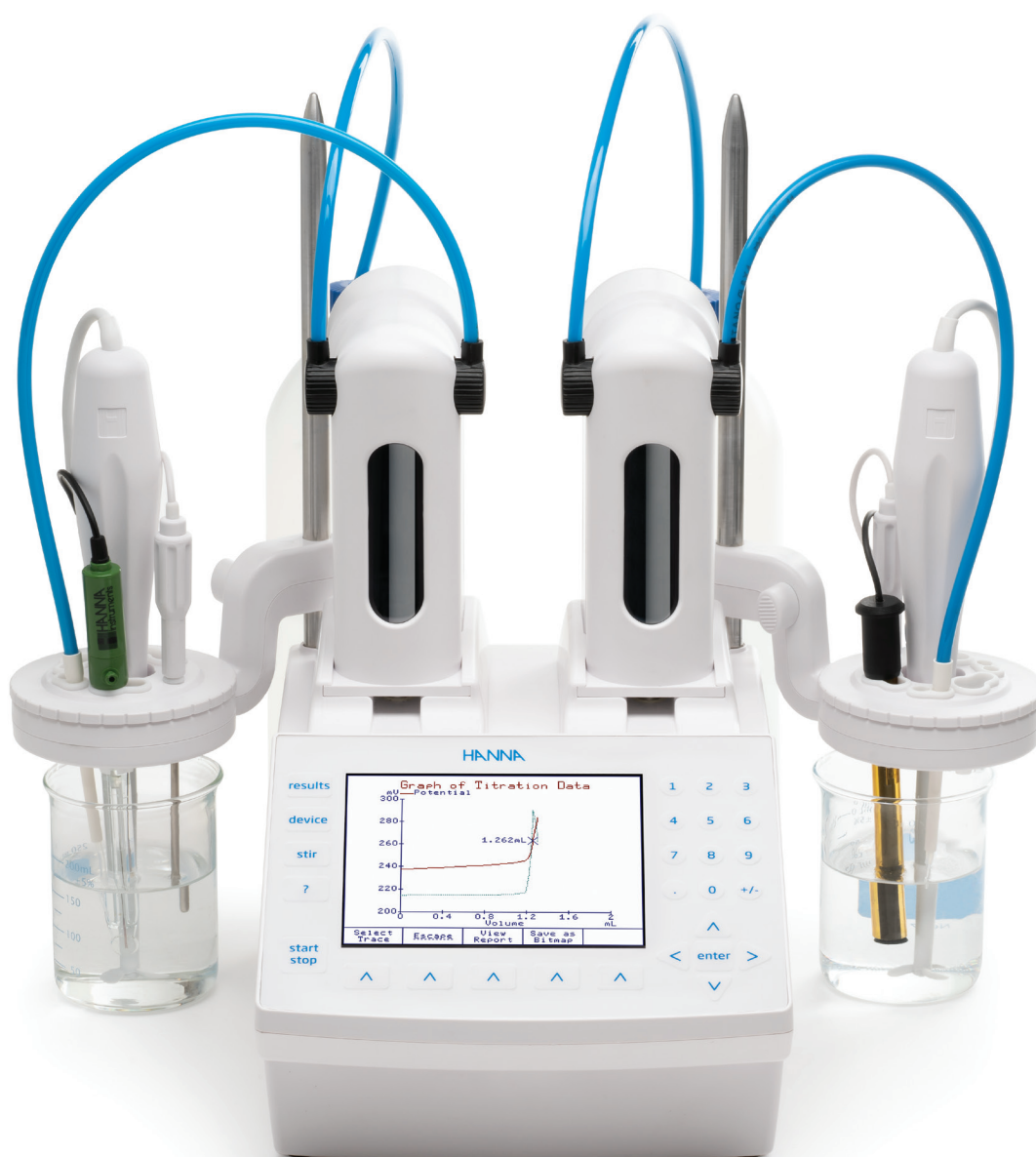

## 1. TITRATION THEORY

### 1.1. INTRODUCTION

A titration is a quantitative, volumetric procedure used in analytical chemistry to determine the concentration of an analyte (the species being measured) in solution. The concentration of the analyte is determined by slowly adding a titrant (reagent) to the solution. As the titrant is added, a chemical reaction occurs between the titrant and the analyte. Titration reactions are relatively fast, simple reactions that can be expressed using a chemical equation. The titration reaction continues as the titrant is added until all of the analyte is consumed and the analyte reacts completely and quantitatively with the titrant.

The point at which all of the analyte has been reacted is called the equivalence point, also known as the theoretical or stoichiometric endpoint. This point is accompanied by an abrupt physical change in the solution, which sharply defines the endpoint of the reaction. The physical change associated with the titration endpoint can be produced by the titrant, or an indicator, and can be detected visually or by physical measurements.

Titration cannot be used to determine the quantity of all analytes.

The chemical reaction between the titrant and analyte must fulfill four requirements:

- Must be fast and occur within approximately one second after the titrant is added
- Must go to completion
- Must have well-known stoichiometry (reaction ratios)
- A convenient endpoint or inflection point

Titration provides many advantages over alternative methods; they are highly precise, quickly performed and require relatively simple apparatus and instrumentation.

### 1.2. USES OF TITRATIONS

- Acid content of plant effluents, food (e.g.: cheese and wine), plating and etching baths, petroleum products, drugs
- Base content of fertilizer (containing ammonia), bleach, minerals
- Hardness in water
- Metal content of alloys, minerals, ores, clays, waters, plating baths, paints, paper, plant materials, biological fluids, petroleum products
- Moisture content in foodstuffs, petrochemicals, plastics, pharmaceutical products
- Redox reagent concentrations such as available chlorine in potable water, peroxide, traces of oxidants and reductants in food, reductants in high temperature or high pressure boiler water, vitamin analysis

### 1.3. ADVANTAGES & DISADVANTAGES

Advantages of titration as an analytical technique:

- More precise results than many instrumental methods, such as measurement by electrode, the accuracy of the measurement is up to 0.1%
- Simple methods, reasonable capital costs and easy training
- Suitability to measure major components of a mixture or product
- Automation can reduce time and labor spent on each analysis

Disadvantages of titration as an analytical technique:

- The time it takes to prepare standards and titrants
- Good technique is required to achieve precise results (training and practice required)
- Not suitable for determining trace or minor components of a mixture or product
- Limited dynamic range, it may require additional sample preparation (dilution) and repeat analyses

## 2. TYPES OF TITRATIONS

### 2.1. TITRATIONS ACCORDING TO THE MEASUREMENT METHOD

#### 2.1.1. AMPEROMETRIC TITRATIONS

An amperometric titration is performed by placing two electrodes (typically a metal ion-selective electrode and a reference electrode) into the sample solution and keeping the potential of the metal electrode at a selected voltage. The current that flows, due to the oxidation or reduction of a reactant or product, is plotted vs. volume of titrant to provide the titration curve and locate the equivalence point. Changes in the current are due to changes in the concentration of a particular species (being oxidized or reduced at the electrode).

Generally, the reaction between the analyte and titrant forms a new species. Depending on the titration, the reactants are electroactive and the products are not or vice-versa. Amperometric titration curves look like two straight lines intersecting at the equivalence point, this is due to the change in the electroactivity of the solution. **Figure 1A**, Amperometric titrations, shows an active analyte and non-reactive titrant. **Figure 1B** and **1D**, Amperometric titrations, shows a nonreactive analyte and a reactive titrant. **Figure 1C**, Amperometric titrations, shows a reactive analyte and titrant.

Many metal ions can be amperometrically titrated using a precipitation, complexation or redox reaction. Some metal ions and species that can be determined in this manner include silver, barium, halides, potassium, magnesium, palladium, molybdate, sulfate, tungstate, zinc, bismuth, cadmium, fluoride, indium, thallium, iodine and gold.

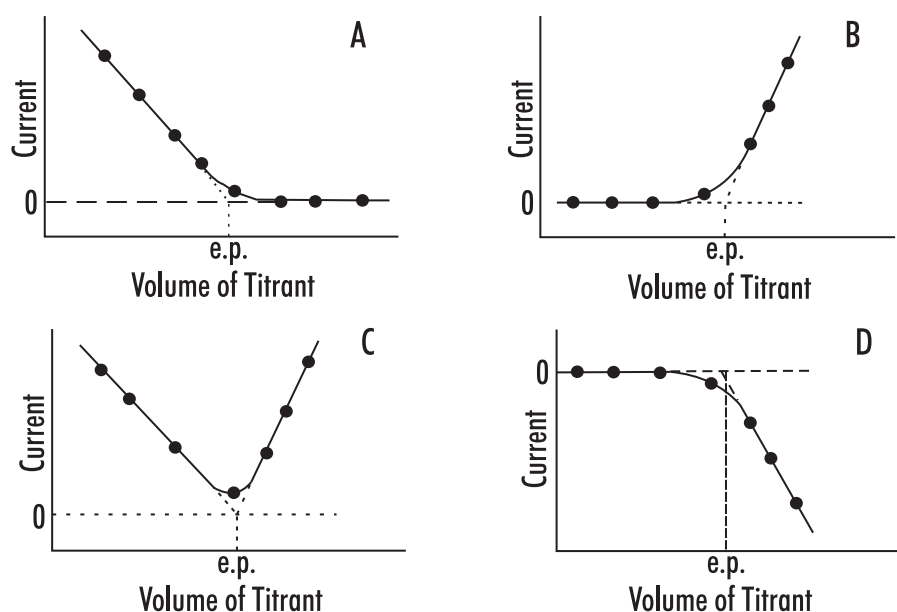

Figure 1: Amperometric titrations

#### 2.1.2. POTENTIOMETRIC TITRATIONS

Potentiometric titrations are done by measuring the voltage across the solution using an electrode system. An electrode system consists of an indicator electrode and a reference electrode. As titrant is added, the variations in the potential of the indicator electrode, with respect to the reference electrode, are monitored to show the progress of the titration.

Potentiometry is the measurement of a potential under conditions of zero current flow. The measured potential can then be used to determine the analytical quantity of interest, generally a component concentration of the analyte solution. The potential that develops in the electrochemical cell is the result of the free energy change that would occur if the chemical phenomena were to proceed until the equilibrium condition has been satisfied.

There are many types of titrations where potentiometry can be used, e.g. pH electrodes for acid-base titrations, platinum ORP electrodes in redox titrations, ion-selective electrodes, such as chloride or fluoride for a specific ion titration, and silver electrodes for argentometric (silver-based) titrations.

In **Figure 2A**, Potentiometric titrations, the pH of the solution is plotted against the volume of titrant. In **Figure 2B**, Potentiometric titrations, the electrode potential is plotted against the volume of titrant.

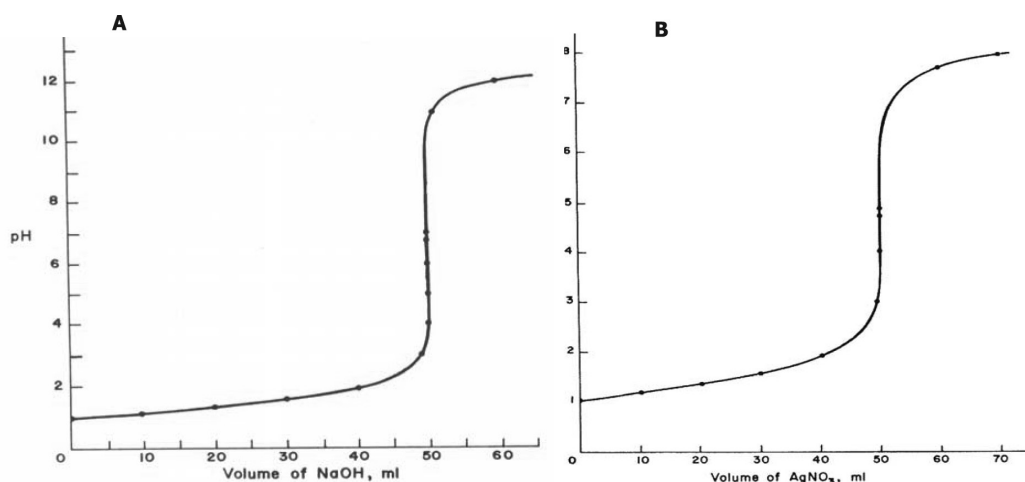

**Figure 2:** Potentiometric titrations

### 2.1.3. SPECTROPHOTOMETRIC TITRATIONS

The name comes from the method used to detect the endpoint of the titration, not its chemistry. Highly colored indicators that change color during the course of the titration are available for many titrations. More accurate data on the titration curve can be obtained if the light absorption is monitored instrumentally using a light source, a simple monochromator and a photodetector, rather than visually determining the color or light absorption change. Light absorption by either an indicator or by one of the reactants or products can be used to monitor the titration.

In **Figure 3A**, Spectrophotometric titrations, the absorption of a metal-indicator complex is being monitored. The absorption is constant while the metal is complexed by the ethylenediaminetetraacetic acid (EDTA) titrant. The metal indicator complex was stripped, causing a sharp break in the titration curve. The point where all the metal is complexed and stripped from the indicator is the equivalence point. This point is marked by "e.p." on the graph.

In **Figure 3B**, Spectrophotometric titrations, the metal complex is being measured while being titrated with EDTA. The new complex being formed is not colored and does not absorb light. The extrapolated intersection of the two lines determines the equivalence point.

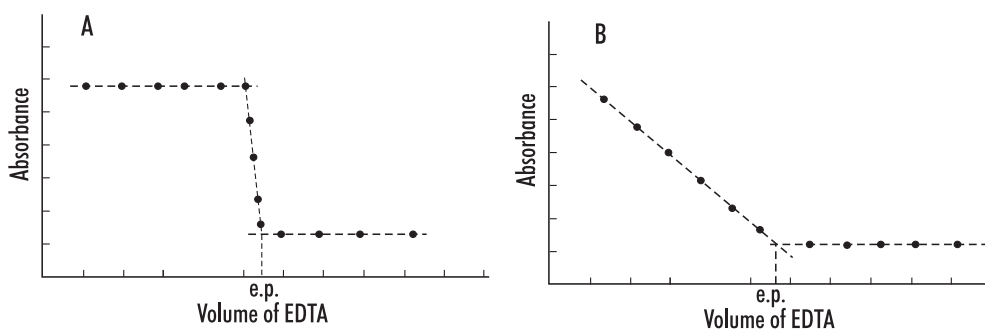

**Figure 3:** Spectrophotometric titrations



## 2.2. TITRATIONS ACCORDING TO THE REACTION TYPE

### 2.2.1. ACID-BASE TITRATIONS

Acid-base titrations are the most common type of titrations. They are based upon a reaction between an acid and a base, a stoichiometric neutralization or the exchange of protons. Virtually all acid-base titrations are carried out using a strong acid or a strong base as the titrant. The endpoint of a titration carried out with a weak acid or a weak base would be difficult to detect due to a small change in pH at the equivalence point.

Chemical indicators can be used to determine the endpoint. The indicator will change color to signify that the end of the titration has been reached. The color of the indicator is dependent upon the concentration of ions in the solution. An acid-base indicator is composed of a conjugate weak acid-weak base pair, where the two forms exhibit different colors depending on the pH of the solution. For an indicator, the acid ionization constant ( $K_a$ ) is usually written as:

$$K_a = \frac{[H_3O^+][In^-]}{[HIn]}$$

HIn is the acid form of the indicator and  $In^-$  is the base form. At the center of the change region, the ratio of  $[In^-]$  to  $[HIn]$  is one,  $[H_3O^+] = K_a$  and  $pH = pK_a$ . The color change region is usually  $\pm 1$  pH unit around this point.

**Table 1**, Aqueous acid-base chemical indicators, contains a list of aqueous acid-base chemical indicators, the pH range, the  $pK_a$  and the expected color (acid and base form). It is generally recommended to select a chemical indicator that has a  $pK_a$  as close to the endpoint of the titration as possible.

When chemical indicators are not suitable, a potentiometric pH titration can also be used. The pH of the solution is plotted versus the volume of titrant added.

**Table 1:** Aqueous acid-base chemical indicators

pH Range	Indicator	$pK_a$	Acid Form	Base Form
0.0 - 1.6	Methyl Violet		Yellow	Blue
1.2 - 2.8	Thymol Blue	1.65	Red	Yellow
3.2 - 4.4	Methyl Orange	3.46	Red	Yellow
3.8 - 5.4	Bromocresol Green	4.90	Yellow	Blue
4.8 - 6.0	Methyl Red	5.00	Red	Yellow
5.2 - 6.8	Chlorophenol Blue	6.25	Yellow	Red
6.0 - 7.6	Bromothymol Blue	7.30	Yellow	Blue
6.6 - 8.0	Phenol Red	8.00	Yellow	Red
7.4 - 9.0	Metacresol Purple	8.30	Yellow	Purple
8.0 - 9.6	Thymol Blue	9.20	Yellow	Blue
8.2 - 10.0	Phenolphthalein	9.50	Clear	Pink
9.4 - 10.6	Thymolphthalein		Clear	Blue
10.1 - 12.0	Alizarin Yellow R		Yellow	Red
11.4 - 12.6	Indigo Carmine		Blue	Yellow

**Figure 4**, Acid-base titration, shows a traditional strong acid-strong base titration curve, the volume of sodium hydroxide (NaOH) added to the solution is plotted against the pH of the solution. Note the abrupt change in the pH at the equivalence point.

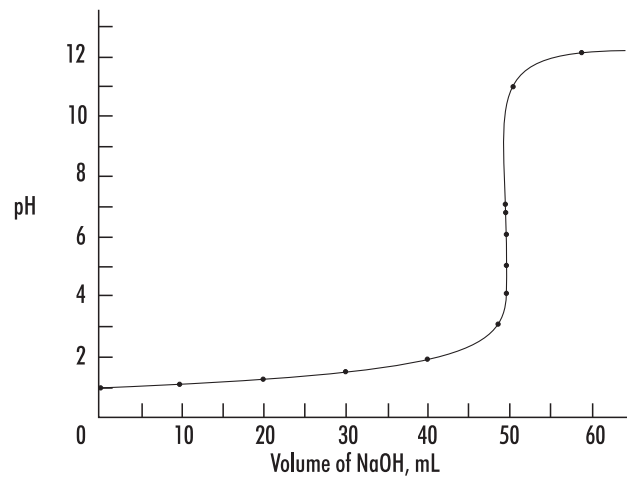

**Figure 4:** Acid-base titration

### 2.2.2. ARGENTOMETRIC TITRATIONS

Argentometric titrations use silver (nitrate) as the titrant and are generally precipitation titrations, as many silver salts are insoluble. These titrations are commonly used to titrate and determine the concentration of bromide, chloride, cyanide, iodide and sulfide.

Argentometric titrations can be done with Mohr's indicator. After all of the chloride has reacted, a red silver chromate precipitate is formed or the titration can be easily followed with a silver ISE (or chloride ISE for chloride titrations) and a reference electrode.

**Figure 5**, Argentometric titration, shows the titration of a sodium chloride solution with silver nitrate ( $\text{AgNO}_3$ ). The volume of  $\text{AgNO}_3$  is plotted against the potentiometric signal from a chloride ISE.

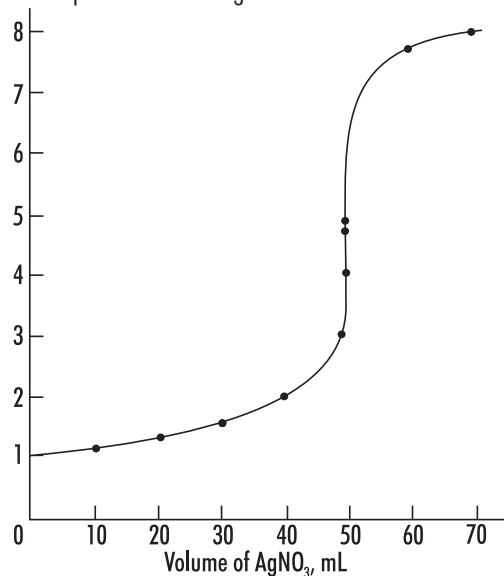

**Figure 5:** Argentometric titration

### 2.2.3. COMPLEXOMETRIC TITRATIONS

A complex is a species where a central metal ion is covalently bonded to one or more electron donating groups called ligands. In a complexometric titration, metal ions are titrated using a titrant that binds strongly to it. Often these titrants contain EDTA

or CDTA, polydentate ligands that form very stable coordination compounds with metal ions. The complexation reaction must be fast in order to be useful for direct titration. Some metal ions react too slowly with EDTA for a direct titration.

An indicator electrode that responds to the metal ion can be used to monitor the titration progress. The titration curve will appear similar to a potentiometric titration. Complexation indicators change color at the endpoint as all metal ions are “consumed” or complexed by the titrant.

**Figure 6**, Complexometric titration, shows a typically complexometric titration curve when using an indicator electrode that responds to the metal ion.

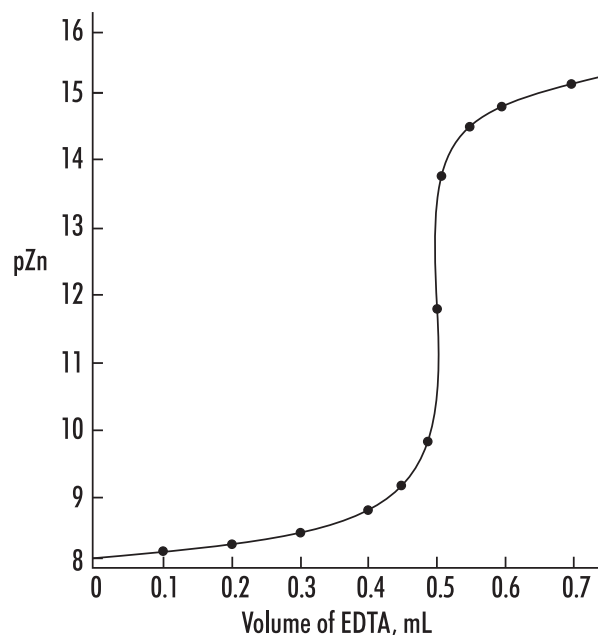

**Figure 6:** Complexometric titration

### 2.2.4. ION-SELECTIVE TITRATIONS

The most popular ion-selective titration is an acid-base titration. The hydrogen ion concentration is specifically measured and monitored during the titration process to locate the equivalence point. Using an ion-selective electrode (ISE) as the indicator electrode, the potentiometric signal (in mV) is used to directly follow a specific ion's concentration (or activity). Examples of ISE titrations include titrating fluoride with an aluminum titrant using a fluoride ISE, chloride with silver nitrate using a chloride ISE, sodium with a sodium ISE, etc. The equivalence point can be determined by plotting the mV value vs. the amount of titrant added.

### 2.2.5. NON-AQUEOUS SOLVENT ACID-BASE TITRATIONS

Non-aqueous solvents must be used to titrate very weak acids and bases due to the inherent leveling effect water has on all acids and bases dissolved in it. A wide variety of weak acids and bases can be titrated using non-aqueous solvents. Mixtures of acids or bases can often be individually analyzed in a single sequential titration.

### 2.2.5.1. TITRATION OF ACIDS

Weak acids with  $pK_a$ 's up to about 11 can be titrated in non-aqueous solvents. These include carboxylic acids, enols, phenols, imides, sulfonic acids and inorganic acids. Water or lower alcohols are suitable for titrating medium to strong acids ( $pK_a$  less than 5). Titrating a weaker acid with a strong base titrant requires a solvent less acidic than water or ethanol/methanol. Solvents such as acetone, acetonitrile, *t*-butyl alcohol, dimethylformamide, isopropanol and pyridine have been found to work well for acid-base titrations of strong, medium and weak acids/bases. Titrants include alcoholic potassium hydroxide and various sodium or potassium alkoxides in a 10:1 mixture of benzene/methanol. The best titrants are quaternary ammonium hydroxides (such as tetrabutylammonium hydroxide) due to good solubility of tetraalkylammonium salts of the titrated acids and the clean potentiometric titration curve obtained. **Figure 7**, Non-aqueous titration, shows an example of titration with tributylmethylammonium hydroxide titrant.

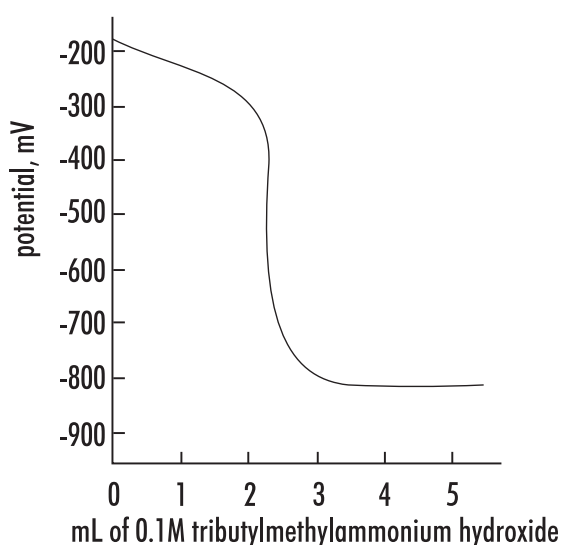

**Figure 7:** Non-aqueous titration

### 2.2.5.2. TITRATION OF BASES

Weak bases with  $pK_b$ 's up to about 11, which do not ionize with water, can be titrated in non-aqueous solvents. These bases include aliphatic and aromatic amines, basic nitrogen heterocycles, alkali metal and amine salts of acids, and many other organic basic compounds. Titrating a weak base with a strong acid titrant requires a basic solvent that is as weak as possible. Water and alcohols allow the titration of medium strength bases, such as aliphatic amines ( $pK_b = 4$  to 5), but not the titration of weaker bases such as pyridine ( $pK_b = 8.8$ ). Glacial acetic acid works well for weak bases and has been used extensively. Less basic solvents such as acetone, acetonitrile and nitromethane extend the range of titratable compounds.

The endpoint for non-aqueous titrations are usually determined potentiometrically using a pH glass electrode, a modified calomel or double junction reference electrode with a low-flow rate reference junction. Good potentiometric titration curves are obtained in most solvents, except those with very low dielectric constants such as benzene or chloroform, when high electrical resistance of the solvent causes unstable potentials.

### 2.2.6. PRECIPITATION TITRATIONS

Precipitation titrations allow for faster analysis when compared to gravimetric analysis, where a precipitate is formed, filtered, dried and weighed to analyze a compound. Typically silver halides, silver thiocyanate and a few mercury, lead, and zinc salts are titrated using this method. The chemical reactions must form an insoluble salt and precipitate out quickly in order to be analyzed by this method. When the reaction is not quick, a back titration can be used. A measured excess of the precipitating reagent (titrant) is added to force the reaction to occur, and then unreacted titrant is titrated with a standard solution of another reagent.

### 2.2.7. REDOX TITRATIONS

There are a number of oxidation-reduction reactions that can be used to determine unknown concentration by titration. If the reaction goes to completion, is fast and has an analytical signal available to follow it, a titration can be performed. The term “fast” means that each addition of titrant is reacted completely and the sensing electrode is able to detect the change in solution in less than one second. **Figure 8**, Redox titration, shows an example of a redox titration using Cerium (IV) as a titrant.

Redox titrations are potentiometric titrations where the mV signal from a combination ORP (redox) electrode (usually with a platinum indicator electrode) is used to follow the reaction of oxidant/reductant. The electrode potential is determined by the Nernst equation and is controlled by the oxidant/reductant ratio.

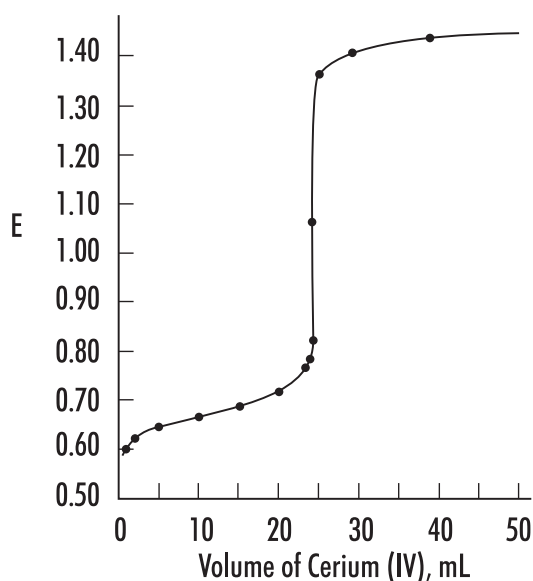

**Figure 8:** Redox titration

Visual indicators, such as Ferroin, are also available. The oxidized and reduced form of the indicator will have different colors and can be used to determine the endpoint.

Various reductants can be determined by titrants with oxidants such as potassium permanganate, potassium chromate or iodine. Commonly used reductants that are used as titrants include sodium thiosulfate and ferrous ammonium sulfate. As with acid-base titrations, the potential changes dramatically at the equivalence point.

### 2.2.8. KARL FISCHER TITRATIONS

This method is based on a well-defined chemical reaction between water and the Karl Fischer reagent. The chemistry provides excellent specificity for water determination. The method can be used to determine free and bound water in a sample matrix. The Karl Fischer method is widely considered to produce the most rapid, accurate and reproducible results and has the largest detectable concentration range spanning 1 ppm to 100%.

The determination of water content is one of the most commonly practiced methods in laboratories around the world. Knowledge of water content is critical to understanding chemical and physical properties of materials and ascertaining product quality. Water content determination is conducted on many sample types including pharmaceuticals and cosmetics, foods and natural products, organic and inorganic compounds, chemicals, solvents and gases, petroleum and plastic products as well as paints and adhesives. The KF method is verifiable and can be fully documented. As a result, Karl Fischer titration is the standard method for analysis of water in a multitude of samples as specified by numerous organizations including the Association of Official Analytical Chemists, the United States and European Pharmacopoeia, ASTM, American Petroleum Institute, British Standards and DIN.

## 2.3. TITRATIONS ACCORDING TO THE TITRATION SEQUENCE

### 2.3.1. BACK TITRATIONS

Back titrations are generally used when a reaction is too slow to be directly accomplished during a “direct” titration, where the reaction goes to completion within a few seconds. In a back titration, a large excess of a reagent is added to the sample solution, helping a slow reaction to go to completion. The unreacted, excess reagent is then titrated. The difference in the total volume of the first reagent added and amount determined from the second titration is the quantity of reagent required to complete the first reaction.

### 2.3.2. MULTIPLE ENDPOINT TITRATIONS

Under certain conditions, some titrations can exhibit more than one equivalence point and be titratable to the individual endpoints to determine the concentration of each individual component. Examples of these types of titrations include acid-base (different strengths acids or bases are in a mixture), redox (each species has a different reduction potential), complexometric (different species are separately titratable), and acid-base, using polyprotic acids (the  $pK_a$  of the different protons varies enough to separate them).

In **Figure 9A**, Multiple endpoint titrations, a titration of a polyprotic acid is shown, the different acid strengths of the first and second proton can be determined. **Figure 9B**, Multiple endpoint titrations, shows a titration with two different metal redox species, the different redox potentials allow the species to be separated. In **Figure 9C**, Multiple endpoint titrations, the solution being titrated contains a mixture of strong, weak, and very weak acids, the different  $pK_a$ 's allow the species to be separated.

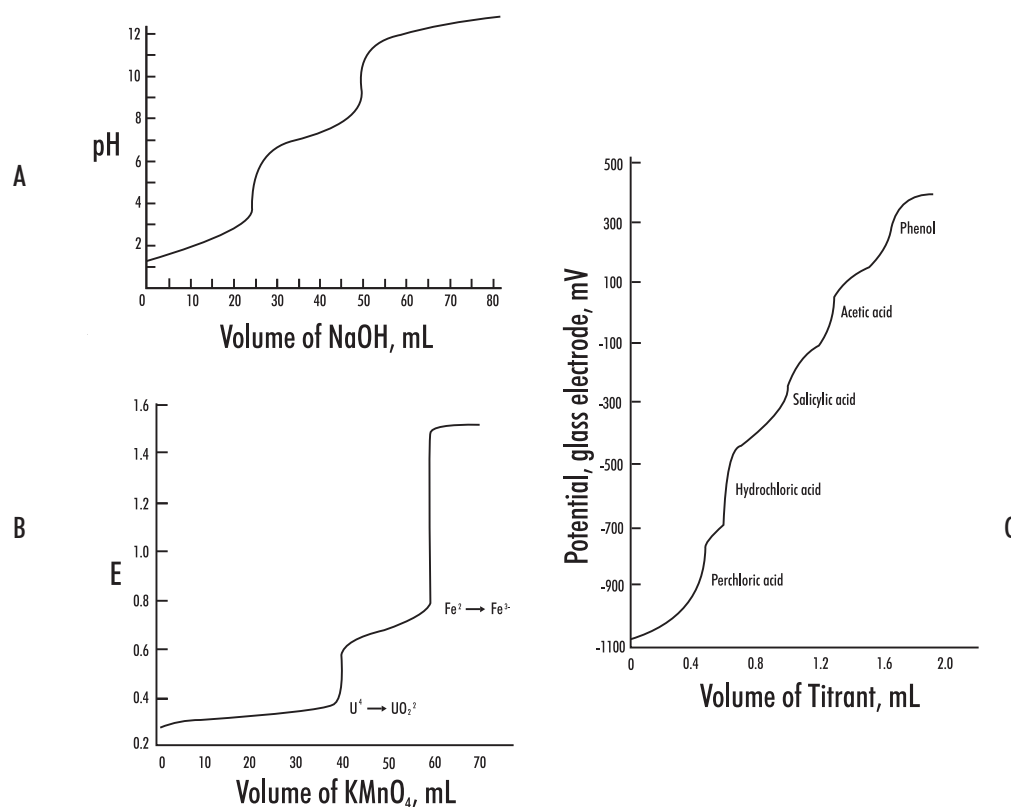

Figure 9: Multiple endpoint titrations

### 3. TITRATION PROCEDURE

#### 3.1. MANUAL TITRATION

Apparatus required for manual titration include:

- Volumetric burette, for precisely controlled delivery of titrant to the reaction vessel
- Erlenmeyer, or similar flask, that facilitates constant mixing or swirling required to ensure solution homogeneity
- Volumetric pipettes for the precise addition of samples and indicator solutions
- Titrant solutions of known concentration
- A visual or instrumental indicator for detecting the completion of the reaction

A typical manual titration consists of the following steps:

- 1) A volumetric pipette is used to add a known volume of sample to the flask.
- 2) An indicator solution or instrument probe is added to the flask.
- 3) A burette is used to measure the addition of titrant to the flask and dispense titrant in a controlled manner.
- 4) Titrant is added via the burette until the method indication signals the reaction endpoint.
- 5) Analyte concentration is calculated based on the concentration and volume of titrant required to reach the endpoint.

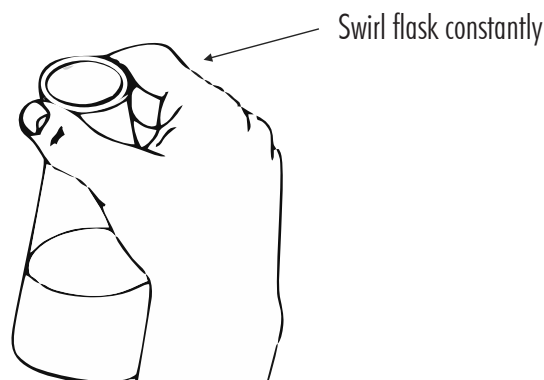
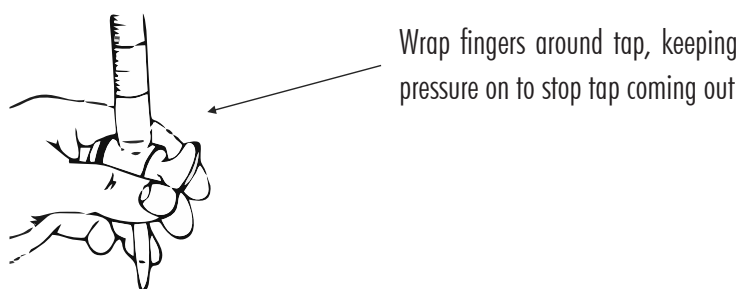

#### 3.2. AUTOMATIC TITRATION

Automatic titrators are high-precision analytical instruments that deliver the titrant, monitor the physical change associated with the titration reaction, automatically stop at the endpoint and calculates the concentration of the analyte. Automatic titrators are best for repetitive titrations and high-accuracy analyses.

An automatic titrator must have an accurate liquid dispensing system. In high-accuracy systems like the **HI900**-series titrators, the liquid dispensing system consists of three main components: motor-driven syringe burette capable of accurately and precisely dispensing very small volumes of titrant, valve system capable of switching between titrant intake and outlet and a dispensing tip. These three main subsystem components must be as accurate as possible, with very low gear backlash in the burette pump, minimal piston seal flexing, precision ground inner diameter of the glass syringe, a low dead-volume valve, minimal evaporation/permeation, and chemically resistant tubing.

Apparatus required for automatic titration include:

- An automatic titrator, equipped with a burette
- A beaker
- An electronic stirring system, either a propeller stirrer or a magnetic stir bar and stir plate
- Volumetric pipettes for the precise addition of samples
- Standard titrant solutions of known concentration
- An electrode system that can be used to determine the endpoint of the titration

A typical automatic titration consists of the following steps:

- 1) Set up the automatic titrator according to the manufacturer's instructions.
- 2) Use a volumetric pipette to add a known volume of sample to the beaker.
- 3) Submerge the propeller stirrer or add the stir bar to the beaker and turn on.
- 4) Start the titration.
- 5) The titrator will automatically stop at the endpoint and determine the concentration of the analyte.



## 4. TITRATION RESULTS

### 4.1. ACCURACY

The factors most critical to achieving accurate results with the **HI900** titration systems are the concentration of the sample, size of the sample and having an optimized set of method parameters.

### 4.2. REPEATABILITY

Repeatability or the agreement between replicate determinations, is expressed quantitatively as the relative standard deviation (RSD).

### 4.3. SOURCES OF ERROR

One of the advantages of volumetric analysis is excellent accuracy and precision. The sources of error can be grouped into sampling, titrant and standards, chemical reactions, endpoint determination and calculations.

#### 4.3.1. SAMPLING ERRORS

- Selection of a non-homogeneous or non-representative sample
- Sample changed or was contaminated during collection, storage or transfers
- Poor technique when transferring sample to beaker or flask
- Errors in the balance (calibrate and check balance regularly)

#### 4.3.2. PREPARATION ERRORS

Incorrect preparation due to:

- Poor technique in weighing the salt or when transferring to volumetric glassware
- Low-purity salts or water used to make titrant and standard
- Dirty or wet glassware
- Improper storage of titrant or standard which allows water gain, evaporation or deterioration
- Failure to standardize frequently, to adjust for change in titrant
- Failure to flush titrator tubing with a volume of titrant before standardizing
- Volume errors from pipettes and volumetric flasks (grade A glassware is required)
- Balance errors when weighing out salts (calibrate and check balance regularly)

#### 4.3.3. DISPENSING ERRORS

Incorrect dispensing due to:

- Dead valve volume and leaking valve
- Inaccuracy in motor drive and gear lash or backlash
- Poor burette or piston seal
- Non-uniform diameter of burette glass cylinder
- Chemical incompatibility with tubing or bubble generation
- Density or temperature changes in titrant
- Inadequate volume to cover electrode

#### 4.3.4. CHEMICAL REACTION ERRORS

- Inappropriate solvent or sample, resulting in side reactions
- Poor mixing in the titration vessel
- Reaction between titrant and sample is not rapid
- Reaction does not go to completion
- Reaction has side reactions

#### 4.3.5. ENDPOINT DETERMINATION ERRORS

Most manual titrations use a visual indicator to indicate when the endpoint is reached and the titration should be stopped. Automatic titrators use instrumental methods to determine the end of a titration and the equivalence point. There are two predominant methods used to determine the equivalence point, first derivative and second derivative.

The first derivative is often used to determine the inflection point. The inflection point of the titration curve (mV vs. volume) is normally assumed to be the equivalence point. The maximum value of the first derivative ( $\Delta mV$  vs.  $\Delta V$ ) corresponds to the theoretical equivalence point. During a titration it is rare to have a data point exactly at the first derivative maximum, the maximum value is determined by interpolating the first derivative data points.

The second derivative ( $\Delta mV^2$  vs.  $\Delta V^2$ ) can also be used to determine the equivalence point, and can offer advantages over the first derivative method. Second derivatives have increased sensitivity to smaller inflection points and easier numerical evaluation of the actual equivalence point. The value where the second derivative is equal to zero is the equivalence point. The second derivative requires fewer points located near the equivalence point, where data is often not obtained or not as reliable.

Errors in determining the endpoint can result from:

- Incorrect signals from the sensor
- Sensor drift
- Sensor or instrument has slow response (it is recommended to keep the sensors in good condition)
- Inappropriate setting on the titrator

## 5. CALCULATIONS

The main variables used in calculating a result from a titration are the sample volume, the concentration of the titrant, and the volume of titrant required to reach the equivalence point. At the equivalence point, an equal number of equivalents of the analyte and titrant has been added.

### 5.1. SAMPLE CALCULATION BY MASS

$$C_{\text{sample}} = \frac{V_{\text{titrant}} \times C_{\text{titrant}} \times \text{Ratio} \times \text{FW}_{\text{analyte}}}{m_{\text{sample}}} \times 100$$

$C_{\text{sample}}$	Sample Concentration (g/100g)
$V_{\text{titrant}}$	Volume of Titrant
$C_{\text{titrant}}$	Titrant Concentration (eq/L)
Ratio	Equivalence Ratio of analyte / titrant (mol analyte / eq titrant)
$\text{FW}_{\text{analyte}}$	Formula Weight of the Analyte (g/mol)
$m_{\text{sample}}$	Mass of Sample (g)

### 5.2. SAMPLE CALCULATION BY VOLUME

$$C_{\text{sample}} = \frac{V_{\text{titrant}} \times C_{\text{titrant}} \times \text{Ratio} \times \text{FW}_{\text{analyte}}}{V_{\text{sample}}} \times 100$$

$C_{\text{sample}}$	Sample Concentration (g/100mL)
$V_{\text{titrant}}$	Volume of Titrant
$C_{\text{titrant}}$	Titrant Concentration (eq/L)
Ratio	Equivalence Ratio of analyte / titrant (mol analyte / eq titrant)
$\text{FW}_{\text{analyte}}$	Formula Weight of the Analyte (g/mol)
$V_{\text{sample}}$	Volume of Sample (mL)

### 5.3. STANDARDIZE TITRANT BY MASS

Titrant standardization is the second most important calculation in titrations. A primary standard is titrated in order to determine the concentration of the titrant. This is essentially a typical titration calculated in “reverse”, where the concentration of the solution is known and the titrant is unknown.

$$C_{\text{titrant}} = \frac{m_{\text{standard}} \times \text{Ratio}}{\text{FW}_{\text{standard}} \times V_{\text{titrant}}}$$

$C_{\text{titrant}}$	Titrant Concentration (N)
$m_{\text{standard}}$	Mass of Standard (g)
Ratio	Equivalence Ratio of titrant / standard (eq titrant / mol standard)
$\text{FW}_{\text{standard}}$	Formula Weight of the Standard (g/mol)
$V_{\text{titrant}}$	Volume of Titrant (L)

### 5.4. STANDARDIZE TITRANT BY VOLUME

Titrant standardization is the second most important calculation in titrations. A primary standard is titrated in order to determine the concentration of the titrant. This is essentially a typical titration calculated in “reverse”, where the concentration of the solution is known and the titrant is unknown.

$$C_{\text{titrant}} = \frac{V_{\text{standard}} \times (1 \text{ L}/1000 \text{ mL}) \times C_{\text{standard}}}{V_{\text{titrant}}}$$

$C_{\text{titrant}}$	Titrant Concentration (N)
$V_{\text{standard}}$	Volume of Standard (mL)
$C_{\text{standard}}$	Concentration of Standard (eq/L)
$V_{\text{titrant}}$	Volume of Titrant (L)

### 5.5. BLANK TITRATION

In a blank titration a pre-titration is performed, often times on the solvent to be used for the sample titration, and the titrant volume required to reach the endpoint is noted. This blank value nullifies error due to titrant required to react with the components of the titration solution matrix. The basic titration equation can be used for a blank titration, with the single modification that the volume of titrant used in the blank titration should be subtracted from the regular titration titrant volume.

$$C_{\text{sample}} = \frac{C_{\text{titrant}} \times (V_{\text{sample}} - V_{\text{blank}}) \times \text{Ratio} \times \text{FW}_{\text{analyte}}}{m_{\text{sample}}} \times 100$$

$C_{\text{sample}}$	Sample Concentration (g/100 g)
$C_{\text{titrant}}$	Titrant Concentration (eq/L)
$V_{\text{sample}}$	Volume of Titrant required for the sample (L)
$V_{\text{blank}}$	Volume of Titrant required for the blank (L)
Ratio	Equivalence ratio of analyte / titrant (mol analyte / eq titrant)
$\text{FW}_{\text{analyte}}$	Formula Weight of the Analyte (g/mol)
$m_{\text{sample}}$	Mass of Sample (g)

### 5.6. MULTIPLE ENDPOINT TITRATION

Some titrations have two or more endpoints, each corresponding to the equivalence point for a specific reaction. Multiple endpoint titrations are similar to a blank titration in that the volume of titrant required to reach the first endpoint is subtracted from the titrant volume used to reach the next sequential endpoint.

$$C_{\text{sample1}} = \frac{V_{\text{titrant1}} \times C_{\text{titrant}} \times \text{Ratio} \times \text{FW}_{\text{analyte1}}}{m_{\text{sample}}} \times 100$$

$$C_{\text{sample2}} = \frac{(V_{\text{titrant2}} - V_{\text{titrant1}}) \times C_{\text{titrant}} \times \text{Ratio} \times \text{FW}_{\text{analyte2}}}{m_{\text{sample}}} \times 100$$

$$C_{\text{sample3}} = \frac{(V_{\text{titrant3}} - V_{\text{titrant2}}) \times C_{\text{titrant}} \times \text{Ratio} \times \text{FW}_{\text{analyte3}}}{m_{\text{sample}}} \times 100$$

$C_{\text{sample1}}$	Sample 1 Concentration (g/100g)
$C_{\text{sample2}}$	Sample 2 Concentration (g/100g)
$C_{\text{sample3}}$	Sample 3 Concentration (g/100g)
$V_{\text{titrant 1}}$	Volume of titrant required to reach the first endpoint (L)
$V_{\text{titrant 2}}$	Volume of titrant required to reach the second endpoint (L)
$V_{\text{titrant 3}}$	Volume of titrant required to reach the third endpoint (L)
$C_{\text{titrant}}$	Concentration of Titrant (N)
Ratio	Equivalence Ratio of analyte / titrant (mol analyte / eq titrant)
$FW_{\text{analyte 1}}$	Formula Weight of the analyte 1 (g/mol)
$FW_{\text{analyte 2}}$	Formula Weight of the analyte 2 (g/mol)
$FW_{\text{analyte 3}}$	Formula Weight of the analyte 3 (g/mol)
$m_{\text{sample}}$	Mass of Sample (g)

### 5.6.1. BACK TITRATION

The equation used in back titration calculations is also similar to the equation for a blank titration. Instead of subtracting the initial amount of titrant needed to react with the blank, the amount of second titrant needed to react with the excess titrant added in the first titration is subtracted from the amount of the first titrant added. The difference between the two amounts is the amount of titrant necessary to reach the first equivalence point.

$$C_{\text{sample}} = \frac{(C_{\text{titrant1}} \times V_{\text{titrant1}} - C_{\text{titrant2}} \times V_{\text{titrant2}}) \times \text{Ratio} \times FW_{\text{analyte}}}{V_{\text{sample}}} \times 100$$

$C_{\text{sample}}$	Sample Concentration (g/100mL)
$C_{\text{titrant 1}}$	Concentration of Titrant 1 (N)
$V_{\text{titrant 1}}$	Volume of Titrant 1 (L)
$C_{\text{titrant 2}}$	Concentration of Titrant 2 (N)
$V_{\text{titrant 2}}$	Volume of Titrant 2 (L)
Ratio	Equivalence Ratio of analyte / titrant (mol analyte / eq titrant)
$FW_{\text{analyte}}$	Formula Weight of the analyte (g/mol)
$V_{\text{sample}}$	Volume of Sample (mL)

## 6. GLOSSARY

### Acid

A chemical species that can donate one or more protons (hydrogen ions).

### Acid-Base Titration

Stoichiometric neutralization titrations, based upon the reaction that occurs between an acid and a base.

### Activity

A physical property corresponding to the concentration of all ions in a solution. Electrodes respond to activity.

### Amperometric Titration

Titrations where the current flow between two electrodes (often a metal electrode and a reference electrode) are used to monitor the titration progress.

### Analyte

The chemical species being measured in a titration.

### Argentometric Titration

Titrations that use silver (nitrate) as the titrant. These titrations are typically precipitation titrations.

### Automatic Titrator

An instrument designed to automatically carry out a titration. It will add the appropriate amount of titrant, determine the endpoint and calculate the results.

### Back Titration

A type of titration where an excess amount of titrant is added to a sample, forcing a sluggish reaction to go to completion. The excess reagent is then "back" titrated with a second titrant.

### Base

A chemical species that can accept one or more protons (hydrogen ions).

### Biamperometric Indication

Uses a dual platinum pin electrode to measure the current flow through a titration solution.

### Bivoltametric Indication

Uses a dual platinum pin electrode to measure the voltage required to maintain a constant current flow through a titration solution while constant voltage is applied across the platinum elements of the electrode.

### Burette

A graduated cylindrical piece of laboratory glassware that is used to dispense precise amounts of solution.

### Complex Ion

A species where a central metal ion is covalently bonded to one or more electron donating groups called ligands.

### Complexometric Titrations

Metal ions are titrated using a titrant that binds strongly to it. The titrants often contain Ethylenediaminetetraacetic Acid (EDTA) or Cyclohexylenedinitrilotetraacetic Acid (CDTA).

### Endpoint

The point where a titration is stopped because a physical change in the solution has indicated a completed titration. Titration endpoints typically coincide with the equivalence point. A fixed value endpoint (pH or mV) can be used as well. The titration will stop at the desired point regardless if the titration is complete.

**Equivalence Point**

The point where the quantity of titrant is stoichiometrically equal to the quantity of analyte.

**Formal**

The theoretical number of equivalents per liter of the solution. It is used in solutions where the exact concentration of a species may be affected by the other ions present, therefore the stated concentration may not be exactly correct.

**Gravimetric Analysis**

A quantitative determination of an analyte based on the mass of the solid.

**Indicator Electrode**

An electrode that responds to the species of interest. The electrode potential is proportional to the concentration or activity of that ion in the solution being measured.

**Indicators**

Chemical indicators are typically organic dyes that change form under different physical conditions, causing a color change that can be seen by an analyst. Typically used in manual titrations, chemical indicators have been replaced with electrometric indicators, which are used with automatic titrators.

**Inflection Point**

The point on a titration curve where the second derivative curve changes signs.

**Ion-Selective Electrode (ISE)**

An electrode that responds to a specific ion. The electrode potential is proportional to the concentration or activity of that ion in the solution being measured.

**Karl Fischer Titration**

A titration that uses a chemical reaction that is specific for determining water.

**Manual Titration**

A titration that is carried out by hand. The analyst must add the appropriate amount of titrant, determine the endpoint and calculate the results.

**Molar**

The concentration of a solute in a solution.

**Mole (mol)**

A quantity of a chemical species. The molecular weight of a substance in grams is equal to the mass of one mole of the substance. One mole is equal to  $6.022 \times 10^{23}$  atoms or molecules.

**Monochromator**

A device that allows only a narrow range of wavelengths to pass through it by separating the light into different wavelengths.

**Multiple Endpoint Titration**

A titration that reacts multiple species in solution, sequentially, using the same titrant. The concentration of each analyte can be determined from their respective endpoints.

**Nernst Equation**

The fundamental equation relating cell voltage to the concentration of a solution.

**Neutralization**

A chemical reaction where an acid and a base react to form a neutral salt and water.

**Non-aqueous**

A solution that does not contain water.

**Non-aqueous Titration**

A titration that is performed in non-aqueous solutions, typically used to titrate very weak acids and bases to eliminate the leveling effect water has on all acids and bases dissolved in it.

**Normal**

The concentration of a solution which accounts for any stoichiometric difference between the various species in a solution.

**Oxidation / Reduction Potential (ORP)**

The measurement describing whether a species wants to donate or accept electrons from other species in a redox reaction. If a solution's reduction potential is higher than the species it is reacting with, it will typically gain electrons or be reduced. If the potential is lower than the species it is reacting with, it will typically lose electrons or be oxidized.

**Oxidant**

The species that is accepting electrons in a redox reaction.

**Pipette**

Scientific apparatus that is used to deliver precise volumes of liquids.

**Polyprotic Acid**

Acids that are capable of donating more than one proton per acid molecule.

**Potentiometric Titration**

A titration in which the endpoint is determined by monitoring the voltage of the solution using an electrode.

**Precipitation Titration**

A titration in which the analyte reacts with the titrant to form an insoluble compound. The endpoint is typically detected with an ISE sensitive to either the analyte or titrant.

**Reagent**

The chemical added in a titration that causes the given reaction to occur.

**Reduction-Oxidation Reaction (redox)**

A chemical reaction in which the atoms involved in the reaction have their oxidation numbers changed. Reduction is the gain of electrons, which decreases the oxidation number. Oxidation is the loss of electrons, which increases the oxidation number.

**Reductants**

The electron donor in a redox reaction.

**Reference Electrode**

An electrode that supplies a constant electrode potential. It is used in combination with an "indicator" electrode, allowing for the "indicator" electrode potential to be measured.

**Relative Standard Deviation (RSD)**

A measure of the amount of relative variation in a set of data. It is calculated by dividing the standard deviation by the mean:  $RSD = (\text{Standard Deviation of } X) * 100 / (\text{Mean of } X)$

**Repeatability**

The variation in sample measurements taken by a single person or instrument under the same conditions.



**Spectrophotometric Titration**

A titration in which the endpoint is marked by a change in color and/or color intensity.

**Stoichiometry**

The quantitative relationship of the reactants and products in a chemical reaction.

**Titrant**

The chemical added in a titration that causes the given reaction to occur.

**Titration**

A quantitative, volumetric procedure used in analytical chemistry to determine the concentration of an analyte in solution. The concentration of the analyte is determined by slowly adding a titrant to the solution. As the titrant is added, a chemical reaction between the titrant and the analyte occurs.

**Titration Curve**

A graph containing the physical data obtained for a titration. The data plotted is often an independent variable (volume of titrant) vs. a dependent variable (pH of the solution). From the titration curve, the equivalence point or endpoint can be determined.

## Certification

All Hanna Instruments conform to the **CE European Directives**.



RoHS  
compliant

**Disposal of Electrical & Electronic Equipment.** The product should not be treated as household waste. Instead hand it over to the appropriate collection point for the recycling of electrical and electronic equipment which will conserve natural resources.

Ensuring proper product and battery disposal prevents potential negative consequences for the environment and human health. For more information, contact your city, your local household waste disposal service, the place of purchase or go to [www.hannainst.com](http://www.hannainst.com).



## Recommendations for Users

Before using this product, make sure it is entirely suitable for your specific application and for the environment in which it is used. Any variation introduced by the user to the supplied equipment may degrade the meters' performance. For yours and the meter's safety do not use or store the meter in hazardous environments.

## Warranty

The **HI932** is warranted for two years against defects in workmanship and materials when used for its intended purpose and maintained according to instructions. Damage due to accidents, misuse, tampering or lack of prescribed maintenance is not covered.

If service is required, contact your local Hanna Instruments Office. If under warranty, report the model number, date of purchase, serial number and the nature of the problem. If the repair is not covered by the warranty, you will be notified of the charges incurred. If the instrument is to be returned to Hanna Instruments, first obtain a Returned Goods Authorization (RGA) number from the Technical Service department and then send it with shipping costs prepaid. When shipping any instrument, make sure it is properly packed for complete protection.

Hanna Instruments reserves the right to modify the design, construction or appearance of its products without advance notice.

## World Headquarters

Hanna Instruments Inc.  
Highland Industrial Park  
584 Park East Drive  
Woonsocket, RI 02895 USA  
[www.hannainst.com](http://www.hannainst.com)